

## Right choice for ultimate yield

LSIS strives to maximize customers' profit in gratitude of choosing us for your partner.

Programmable Logic Controller

# XGT FEnet I/F Module

**XGT Series**

**User's Manual**

**XGL-EFMT(B)**

**XGL-EFMF(B)**

**XGL-EH5T**



## **Safety Instructions**

- Read this manual carefully before installing, wiring, operating, servicing or inspecting this equipment.
- Keep this manual within easy reach for quick reference.

**LSIS**

<http://www.lsis.com>

# Safety Instructions

## Before using the product ...

For your safety and effective operation, please read the safety instructions thoroughly before using the product. Safety Instructions should always be observed in order to prevent accident or risk with the safe and proper use the product.

Instructions are divided into “Warning” and “Caution”, and the meaning of the terms is as follows.



This symbol indicates the possibility of serious injury or death if some applicable instruction is violated



This symbol indicates the possibility of severe or slight injury, and property damages if some applicable instruction is violated

Moreover, even classified events under its  caution category may develop into serious accidents relying on situations. Therefore we strongly advise users to observe all precautions properly just like warnings.

The marks displayed on the product and in the user’s manual have the following meanings.

 Be careful! Danger may be expected.

 Be careful! Electric shock may occur.

The user’s manual even after read shall be kept available and accessible to any user of the product.

# Safety Instructions

## Safety Instructions for design process

### **Warning**

1. **Please install a protection circuit on the exterior of PLC so that the whole system may operate safely regardless of failures from external power or PLC.** Any abnormal output or operation from PLC may cause serious problems to safety in whole system.
  - (1) Install protection units on the exterior of PLC like an interlock circuit that deals with opposite operations such as emergency stop, protection circuit, and forward/reverse rotation or install an interlock circuit that deals with high/low limit under its position controls.
  - (2) If any system error (watch-dog timer error, module installation error, etc.) is detected during CPU operation in PLC, all output signals are designed to be turned off and stopped for safety. However, there are cases when output signals remain active due to device failures in Relay and TR which can't be detected. Thus, you are recommended to install an addition circuit to monitor the output status for those critical outputs which may cause significant problems.
2. **Never overload more than rated current of output module nor allow to have a short circuit.** Over current for a long period time may cause a fire .
3. **Never let the external power of the output circuit to be on earlier than PLC power,** which may cause accidents from abnormal output or operation.
4. **Please install interlock circuits in the sequence program for safe operations in the system when exchange data with PLC or modify operation modes using a computer or other external equipments**  
Read specific instructions thoroughly when conducting control operations with PLC.

# Safety Instructions

## Safety Instructions for design process

### **Caution**

**I/O signal or communication line shall be wired at least 100mm away from a high-voltage cable or power line.** Fail to follow this instruction may cause malfunctions from noise

## Safety Instructions on installation process

### **Caution**

1. **Use PLC only in the environment specified in PLC manual or general standard of data sheet.** If not, electric shock, fire, abnormal operation of the product may be caused.
2. **Before install or remove the module, be sure PLC power is off.** If not, electric shock or damage on the product may be caused.
3. **Be sure that every module is securely attached after adding a module or an extension connector.** If the product is installed loosely or incorrectly, abnormal operation, error or dropping may be caused. In addition, contact failures under poor cable installation will be causing malfunctions as well.
4. **Be sure that screws get tighten securely under vibrating environments.** Fail to do so will put the product under direct vibrations which will cause electric shock, fire and abnormal operation.
5. **Do not come in contact with conducting parts in each module,** which may cause electric shock, malfunctions or abnormal operation.

# Safety Instructions

## Safety Instructions for wiring process

### **Warning**

1. **Prior to wiring works, make sure that every power is turned off.** If not, electric shock or damage on the product may be caused.
2. **After wiring process is done, make sure that terminal covers are installed properly before its use.** Fail to install the cover may cause electric shocks.

### **Caution**

1. **Check rated voltages and terminal arrangements in each product prior to its wiring process.** Applying incorrect voltages other than rated voltages and misarrangement among terminals may cause fire or malfunctions.
2. **Secure terminal screws tightly applying with specified torque.** If the screws get loose, short circuit, fire or abnormal operation may be caused. Securing screws too tightly will cause damages to the module or malfunctions, short circuit, and dropping.
3. **Be sure to earth to the ground using Class 3 wires for FG terminals which is exclusively used for PLC.** If the terminals not grounded correctly, abnormal operation or electric shock may be caused.
4. **Don't let any foreign materials such as wiring waste inside the module while wiring,** which may cause fire, damage on the product or abnormal operation.
5. **Make sure that pressed terminals get tighten following the specified torque. External connector type shall be pressed or soldered using proper equipments.**

# Safety Instructions

## Safety Instructions for test-operation and maintenance

### **Warning**

1. **Don't touch the terminal when powered.** Electric shock or abnormal operation may occur.
2. **Prior to cleaning or tightening the terminal screws, let all the external power off including PLC power.** If not, electric shock or abnormal operation may occur.
3. **Don't let the battery recharged, disassembled, heated, short or soldered.** Heat, explosion or ignition may cause injuries or fire.

### **Caution**

1. **Do not make modifications or disassemble each module.** Fire, electric shock or abnormal operation may occur.
2. **Prior to installing or disassembling the module, let all the external power off including PLC power.** If not, electric shock or abnormal operation may occur.
3. **Keep any wireless equipment such as walkie-talkie or cell phones at least 30cm away from PLC.** If not, abnormal operation may be caused.
4. **When making a modification on programs or using run to modify functions under PLC operations, read and comprehend all contents in the manual fully.** Mismanagement will cause damages to products and accidents.
5. **Avoid any physical impact to the battery and prevent it from dropping as well.** Damages to battery may cause leakage from its fluid. When battery was dropped or exposed under strong impact, never reuse the battery again. Moreover skilled workers are needed when exchanging batteries.

# Safety Instructions

## Safety Instructions for waste disposal

 **Caution**

- ▶ **Product or battery waste shall be processed as industrial waste.**  
The waste may discharge toxic materials or explode itself.

# Revision History

Version	Date	Remark	Page
V1.0	2005.03	First Edition	-
V1.1	2005.05	Adding the function description	-
V1.2	2005.09	Adding module detachment and how to change Setting PLC type at XG-PD Adding appendix (CPU memory device)	CH3.8 CH5.2 APPENDIX-
V1.3	2005.11	Fixing figure and adding contents	-
V1.4	2005.11	Fixing figure and contents	-
V1.5	2008.07	1. Adding models -adding XGI/XGR redundant system -adding switch module (XGL-EH5T) 2. Adding E-mail service 3. Adding error code table 4. Adding CH 11 Compliance with EMC Specifications 5. Fixing headquarter address	CH1.3.2  CH7.6 CH10.4 CH11 Back cover-
V1.6	2009.09	1. Modifying Overview 2. Adding CPU 3. Adding contents on standard setting (One IP Solution, DHCP)	CH1.2.1 CH1.3.2 CH5.3
V1.7	2011.05	1. How to enable link through flag added 2. Write_NC, Send_NC" instruction added	CH5.5.2 CH7.2.1
V1.8	2013.10	1. Adding Communication load specifications 2. Changing Modbus server offset area	CH2.2.3 CH8.3.1
V1.9	2014.03	1. Changing Communication load specifications 2. Adding info-U, iXP 3. Adding XGR HS Link 4. Adding XGT Dedicated Communication's Header 5. Adding XGT Dedicated Communication's error Code 6. Adding High Performance XGT 7. Changing error code table	CH2.2.3 CH4 CH6.6~6.7 CH8.1.2 CH8 CH9.2.3 CH10.4
V 2.0	2014.11	XG5000 V4.0 UI Update	-
V2.1	2016.10	XGL-EFMTB, XGL-EFMFB contents added	-
V2.2	2017.06	Adding RAPIenet protocol and Cnet protocol	-
V2.21	2017.09	Error code update	CH10.2.2

※ The number of User's manual is indicated right part of the back cover.

Copyright © 2014 LSIS Co., Ltd All Rights Reserved.

## About User's Manual

Congratulations on purchasing PLC of LSIS Co.,Ltd.

Before use, make sure to carefully read and understand the User's Manual about the functions, performances, installation and programming of the product you purchased in order for correct use and importantly, let the end user and maintenance administrator to be provided with the User's Manual.

The User's Manual describes the product. If necessary, you may refer to the following description and order accordingly. In addition, you may connect our website (<http://www.lsis.com/>) and download the information as a PDF file.

### Relevant User's Manuals

Title	Description
XG5000 User's Manual	XG5000 software user manual describing online function such as programming, print, monitoring, debugging by using XGK, XGB CPU
XG5000 User's Manual (for XGI, XGR)	XG5000 software user manual describing online function such as programming, print, monitoring, debugging by using XGI, XGR CPU
XGK/XGB Instructions & Programming User's Manual	User's manual for programming to explain how to use instructions that are used PLC system with XGK, XGB CPU.
XGI/XGR Instructions & Programming User's Manual	User's manual for programming to explain how to use instructions that are used PLC system with XGI, XGR CPU.
XGK CPU User's Manual (XGK-CPUU/CPUH/CPUA/CPUS/CPUE/ CPUSN/CPUHN/CPUUN)	XGK-CPUU/CPUH/CPUA/CPUS/CPUE/CPUSN/CPUHN/CPUUN user manual describing about XGK CPU module, power module, base, IO module, specification of extension cable and system configuration, EMC standard
XGI CPU User's Manual (XGI-CPUU/D,CPUU,CPUH,CPUS,CPUE, CPUUN)	XGI-CPUU/D,CPUU,CPUH,CPUS,CPUE,CPUUN user manual describing about XGI CPU module, power module, base, IO module, specification of extension cable and system configuration, EMC standard
XGR redundant series User's Manual	XGR- CPUH/F, CPUH/T user manual describing about XGR CPU module, power module, extension drive, base, IO module, specification of extension cable and system configuration, EMC standard

Currently user manual of FEnet I/F module is written based on the following version.

### Related OS version list

Item	OS version
XGK-CPUU, CPUH, CPUA, CPUS, CPUE	V4.55
XGI-CPUU/D, CPUU, CPUH, CPUS, CPUE	V4.06
XGK-CPUSN, CPUHN, CPUUN	V1.05
XGI-CPUUN	V1.12
XGR-CPUH/F, CPUH/T, CPUH/S	V2.72
XG5000	V4.21

# © Table of Contents ©

## Chapter 1 Overview

1.1 Introduction .....	1-1
1.2 Features of FEnet I/F Module .....	1-2
1.2.1 Characteristic of FEnet I/F module .....	1-2
1.2.2 Characteristic of XGL-EH5F (switch) .....	1-4
1.3 Product Configuration .....	1-5
1.3.1 Designation .....	1-5
1.3.2 available units to be installed on each CPU .....	1-5
1.4 Software for Product Application .....	1-6
1.4.1 Checking software .....	1-6
1.4.2 XG5000 .....	1-8
1.4.3 Version checking .....	1-8

## Chapter 2 Product Specifications

2.1 General Specifications .....	2-1
2.2 Performance Specifications .....	2-2
2.2.1 XGL-EFMT(B)/EFMF(B) .....	2-2
2.2.2 XGL-EH5T .....	2-3
2.2.3 Specification of Communication load amount .....	2-4
2.3 Structure and Characteristics .....	2-5
2.3.1 Structure of XGL-EFMT(B)/EFMF(B).....	2-5
2.3.2 Structure of XGL-EH5T module .....	2-8
2.4 Cable Specifications .....	2-9
2.4.1 UTP cable .....	2-9
2.4.2 Optical cable .....	2-11

## Chapter 3 Installation and Operation

3.1 Precautions for Installation .....	3-1
3.1.1 Installation .....	3-1
3.1.2 Operation steps.....	3-2

3.2 Installation of the Product .....	3-3
3.2.1 Installation of XGL-EFMT(B) .....	3-3
3.2.2 Installation of XGL-EFMF(B) .....	3-5
3.2.3 Installation of XGL-EH5T .....	3-6
3.3 Operation .....	3-8
3.3.1 Precautions for system configuration .....	3-8
3.3.2 Checklist prior to test operation .....	3-8
3.3.3 How to install or remove the module .....	3-10

## Chapter 4 System Configuration

4.1 Configuration of Network System .....	4-1
4.1.1 Ethernet network composed of LSIS' PLCs.....	4-1
4.1.2 Dedicated network composed of LSIS' PLCs .....	4-2
4.1.3 Combined with Public network and dedicated network system .....	4-2
4.1.4 Ethernet System of Public Network and Dedicated Network .....	4-3
4.1.5 Public network and dedicated network system composed of LSIS' and other company's PLCs .....	4-4
4.1.6 System configuration using dedicated Ethernet between HMIs, PLCs at XGR system .....	4-5
4.1.7 System configuration using dedicated Ethernet between HMIs, PLCs at XGR system .....	4-6
4.1.8 Ethernet, RAPIEnet mixed system configuration through MRS (FEnet V6.0 or above) .....	4-7

## Chapter 5 XG5000 Program

5.1 Introduction .....	5-1
5.2 Basic Settings .....	5-2
5.2.1 PLC type setting .....	5-2
5.2.2 Register of communication module .....	5-3
5.2.3 Standard settings (Module) .....	5-8
5.3 High-speed link Settings .....	5-14
5.3.1 Setting of high-speed link parameters .....	5-14
5.3.2 Setting of high-speed link parameters .....	5-20
5.4 P2P Settings .....	5-21
5.4.1 P2P parameters .....	5-21
5.5 Connect and Download to communication Module .....	5-24
5.5.1 Download/Upload .....	5-24
5.5.2 Enable Link .....	5-27
5.6 System Diagnosis .....	5-31
5.6.1 Execution of the diagnosis function .....	5-31
5.6.2 Type of diagnosis functions .....	5-32

## Chapter 6 High-speed Link Service

6.1 Introduction .....	6-1
6.2 High-speed link Send/Receive Processing .....	6-2
6.3 Operation Sequence through High-speed link .....	6-3
6.4 High-speed link parameters settings .....	6-4
6.4.1 Execution of XG5000 .....	6-4
6.4.2 Standard settings (Module) .....	6-5
6.4.3 High-speed Link parameters (HsLink) .....	6-6
6.5 High-speed Link Information .....	6-19
6.5.1 High-speed link flags .....	6-19
6.5.2 Monitor of High-speed link information .....	6-21
6.6 High Speed Link at Redundant system .....	6-23
6.6.1 In case of redundant network .....	6-23
6.6.2 Monitor of High-speed link information .....	6-25
6.7 High Speed Link at Redundant system .....	6-26
6.7.1 In case of redundant system .....	6-26
6.7.2 In case of single network .....	6-34

## Chapter 7 P2P Service

7.1 Introduction .....	7-1
7.1.1 Introduction to P2P service .....	7-1
7.1.2 Configuration of P2P parameters .....	7-2
7.2 Type of P2P Service .....	7-3
7.2.1 Type of P2P Instructions .....	7-3
7.2.2 Type of P2P Service .....	7-4
7.3 How to Set P2P Service .....	7-5
7.3.1 Ethernet (server) driver .....	7-5
7.3.2 P2P channel .....	7-7
7.3.3 P2P block .....	7-11
7.3.4 User Defined Frame .....	7-14
7.4 P2P Service Operation .....	7-18
7.5 P2P Diagnosis Function .....	7-20
7.6 E-mail service using P2P service .....	7-22
7.6.1 E-mail service .....	7-22
7.7 P2P service at Redundant System .....	7-31

## Chapter 8 Dedicated Communication

8.1	Dedicated Communication	8-1
8.1.1	Introduction	8-1
8.1.2	Frame structure	8-2
8.1.3	List of instructions	8-5
8.1.4	Data type	8-5
8.2	Execution of Commands	8-6
8.2.1	Read separated direct variable	8-6
8.2.2	Read continuous direct variable	8-9
8.2.3	Write separated direct variable	8-11
8.2.4	Write continuous direct variable	8-13
8.2.5	Status read request (MMI -> PLC)	8-15
8.3	Modbus/TCP Dedicated Server	8-20
8.3.1	Driver settings	8-20

## Chapter 9 Remote Connection Service

9.1	Introduction	9-1
9.2	Setting and Connection	9-2
9.2.1	Remote 1 connection (If RS-232C cable used)	9-3
9.2.2	Remote 2 connection (If RS-232C cable is used for local connection)	9-6
9.2.3	Remote 1 connection directly from PC connected with Ethernet	9-8
9.2.4	Remote 2 connection directly from PC connected with Ethernet	9-10

## Chapter 10 Troubleshooting

10.1	Check through communication module LED	10-1
10.1.1	Abnormal operation display XGL-EFMT/EFMF	10-1
10.1.2	Abnormal operation display XGL-EFMTB/EFMFB	10-2
10.1.3	Abnormal operation display XGL-EH5T	10-4
10.2	Module Check with XG5000	10-5
10.2.1	Error check in XG5000	10-5
10.2.2	Error code	10-6
10.3	Module Check through Error Codes	10-10
10.3.1	Troubleshooting	10-10
10.4	Error code received from Comm. module	10-12
10.4.1	Error received from Comm. module	10-12

## Chapter 11 Compliance with EMC Specifications

11.1 Requirements Complying with EMC Specifications .....	11-1
11.1.1 EMC specifications .....	11-1
11.1.2 Panel .....	11-2
11.1.3 Cable .....	11-3
11.2 Requirements Complying with Low Voltage Direction .....	11-4
11.2.1 Specifications applicable to XGT series .....	11-4
11.2.2 Selection of XGT series PLC .....	11-4

## Appendix

A.1 XGT CPU Memory Device List .....	A-1
A.1.1 Device of XGK CPU .....	A-1
A.1.2 Device of XGI CPU .....	A-2
A.1.3 Device of XGR CPU .....	A-2
A.2 Terminology .....	A-3
A.3 List of Flags .....	A-8
A.3.1 List of Special Relays (F) .....	A-8
A.3.2 List of Communication Relays (L).....	A-16
A.4 ASCII Code Table .....	A-22
A.5 Comparison Table of Ethernet Technology .....	A-25
A.6 External Dimensions .....	A-26

# Chapter 1 Overview

## 1.1 Introduction

This user's manual is prepared to describe Fast Ethernet Interface module of XGT series PLC (hereinafter referred to as FEnet I/F module, 1Gbps).

Ethernet is a 'technical standard' established by the international organization of IEEE.

Communication is controlled by CSMA/CD method and network can be established with easy. In addition, a great amount of data can be transferred with high speed. FEnet I/F module is an interface module to communicate data between higher level system such as host PC and PLC, or between PLCs with electric/optical media (10BASE-T/100BASE-TX/1000BASE-T, 100BASE-FX/1000X).

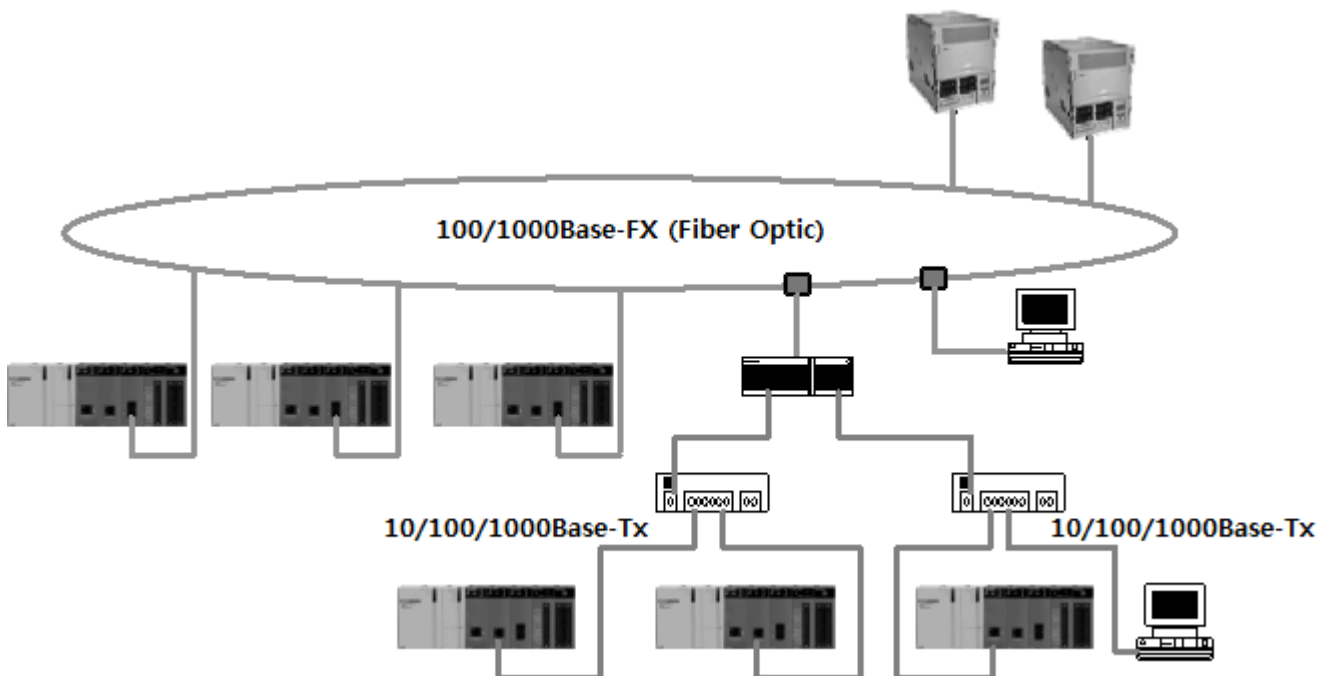

[Fig. 1.1.1] Configuration diagram of FEnet system

FEnet I/F module has variety applicable communication systems. Refer to Chapter 4 System Configuration for detailed system configuration and its description.

- 1) Communication between PLC and host PC (MMI)
- 2) Mutual exchange or monitoring data between PLCs /monitoring
- 3) Data management or system control for field devices.

## 1.2 Features of FEnet I/F Module

### 1.2.1 Characteristic of FEnet I/F module

XGT FEnet I/F module supports TCP/IP and UDP/IP protocols and has the features as specified below;

#### **Fast Ethernet (FEnet I/F module) :**

- ▶ Module exchange on CPU RUN with module exchange switch in the CPU is possible.
- ▶ Module exchange on CPU RUN with module exchange wizard of XG5000 is possible.
- ▶ Conforms to IEEE 802.3 standard (Ethernet standard supported).
- ▶ High-speed link service supported for communication between LSIS' PLCs with high speed.
- ▶ XG5000, a communication parameter configuration tool, is provided.
- ▶ High-speed link block setting available to link between modules.  
(Max. Send Data: 64blocks x 200 words, Max. Receive Data: 128 blocks x 200 words, Totally 128 blocks can be setup. (Send + Receive)) .
- ▶ In addition to High-speed link service, Communication with up to 16 Ethernet devices is available (dedicated communication + P2P communication).  
(FEnet V6.0 or above, Communication with up to 32 Ethernet devices is available.)
- ▶ Loader service (XG5000 connection) is supported through Ethernet: (dedicated TCP/IP PORT: 2002 allotted).
- ▶ It is easy to connect with other company's Ethernet device through P2P communication and XG5000. (Variable READ/WRITE service is available (through Dynamic Connection))
- ▶ 10BASE-T/100BASE-TX/1000BASE-T, 100BASE-FX/1000X media supported.
- ▶ Data is accessible via the public network.
- ▶ LS protocol (XGT) and other company's protocol (MODBUS TCP) supported (dedicated service)
- ▶ Convenient client function supported for communication between LSIS' PLCs and for communication with other company's Ethernet device.  
(XGT, Modbus TCP P2P client function)
- ▶ Dynamic IP supported to make ADSL network available
- ▶ Access table provided for host PC (MMI) and communication security.
- ▶ Dynamic Connection/Disconnection supported through P2P service.
- ▶ Various diagnosis functions and status information of modules and network provided.
  - 1) CPU module status
  - 2) Communication module status
  - 3) Communication service (High-speed link, dedicated service, P2P) status
  - 4) Autoscan function used to visualize the information of LSIS' communication modules connected within the network
  - 5) PING test function provided to check if other modules exist.
  - 6) Type and average amount of packet received by communication module provided (network load predictable)
  - 7) Diagnosis function provided for communication module through the network.

- ▶ E-MAIL service (ASCII) provided.
- ▶ Up to 24 Ethernet communication modules can be installed on main and extension base.  
(For XGR, FEnet module can be installed on only main base)
- ▶ One IP Solution function provided (XGR O/S Version 2.4 or above)
- ▶ XGT Cnet dedicated protocol support (FEnet OS V 6.0 or above)
- ▶ Support MODBUS RTU protocol (FEnet OS V6.0 or above)
- ▶ MODBUS ASCII protocol support (FEnet OS V6.0 or above)
- ▶ RAPIEnet protocol support (FEnet OS V6.0 or above)

### 1.2.2 Characteristic of XGL-EH5T (switch)

Switch module is HUB module having the switching function for interface with system based on Ethernet or XGT FEnet module. It improves the weak points of the external hub module (using external power source and low reliability) and it can be installed on XGT base to simplify the work and reduce the fault factor.

- (1) Available to install at XGT base  
It doesn't need a external power source and can be installed at XGT base. Compact size for easy installation
- (2) Reliability applying to industrial standard  
It passed the noise, environment test based our company standard comparing other switches
- (3) Built-in Auto Cross Over function (For convenience of wiring)
- (4) High speed link function is guaranteed  
It canceled Broadcast storm function for normal operation of High speed link packet
- (5) CHS GROUND supported at RJ-45 connector  
In case of using shielded cable (FTP/STP), effective for reducing the transmission error rate

## 1.3 Product Configuration

### 1.3.1 Designation

Product configuration of XGT FEnet I/F module is as follows;

Designations		Description	Remarks
XGK/XGI/XGR	XGL-EFMT	10BASE-T/100BASE-TX	Category 5 or more(STP)
	XGL-EFMTB	100BASE-TX/1000BASE-T	Category 5 or more(STP)
	XGL-EFMF	100BASE-FX	Fiber Optic (SC)
	XGL-EFMFB	100BASE-FX/1000X	Fiber Optic(LC/SFP)
	XGL-EH5T	10/100BASE-TX	Switch

#### Notes

- 1) AUI (10BASE-5) is not supported in XGT series.
- 2) In the case that UTP cable is used, use the switching hub of 100Mbps, which can be used together with the 10Mbps Ethernet device (category 3 or less) but its baud rate will be limited to 10Mbps.  
Pay attention to installation of the system.
- 3) XGL-EH5T can be installed on XGT base and used as switch without specific program. It has maximum 100Mbps speed

### 1.3.2 Available units to be installed on each CPU

The maximum installation number of modules based on CPU type of each FEnet I/F module is described in the table below. After due consideration of the number of communication modules available, apply such applicable modules to the system configuration.

Segment	XGK								XGI						XGR		
	CPUH	CPUU	CPUA	CPUS	CPUE	CPUSN	CPUHN	CPUUN	CPUU	CPUH	CPUS	CPUE	CPUU/D	CPUU/N	CPUH/T	CPUH/F	CPUH/S
Number of HS Link use module(Maximum)	12 units														6 units		
Number of P2P use modules(maximum)	8 units														6 units		
Maximum number of modules(server use modules included)	24 units														6 units		

## 1.4 Software for Product Application

The following is for main programming tools and other producing software needed to use FEnet I/F module. For more precise application of program and communication, please refer to the details below so to apply to the system.

### 1.4.1 Checking software

#### (1) Application to XGT series

Classification		Programming tool and Frame Setting
XGL-EFMT(B)	10BASE-T/100BASE-TX/1000BASE-T	XG5000
XGL-EFMF(B)	100BASE-FX/1000X	
XGL-EH5T	Switch	No relation

#### (2) CPU version to use FEnet I/F module

Section	Section	Available version (recommended)	Reference
XGK series	XGK-CPUH	V4.55	
	XGK-CPUS	V4.55	
	XGK-CPUA	V4.55	
	XGK-CPUE	V4.55	
	XGK-CPUU	V4.55	
	XGK-CPUSN	V1.05	
	XGK-CPUHN	V1.05	
	XGK-CPUUN	V1.05	
XGI series	XGI-CPUU/D	V4.06	
	XGI-CPUU	V4.06	
	XGI-CPUH	V4.06	
	XGI-CPUS	V4.06	
	XGI-CPUE	V4.06	
	XGI-CPUUN	V1.12	
XGR series	XGR-CPUH/T	V2.72	
	XGR-XPUH/F	V2.72	
Software	XG5000	V4.21	

### Notes

- 1) The software above can be downloaded presently from the web site for its application. If the Internet is not available, please visit the nearest agent of service center to get the applicable installation CD-ROM to use.  
Internet web site : <http://www.lsis.com>
- 2) RS-232C and USB port of CPU module is available for downloading the program made by XG5000 and communication configuration made by XG5000.  
Refer to CPU or XG5000 manual for connection diagram of each cable.
- 3) At the lower version than above table, some function may not work properly. Check the version before using
- 4) Use XG5000 V4.21 or above to operate RAPIEnet, XGT Cnet, Modbus RTU / ASCII (FEnet V6.0 or above) function.

### 1.4.2 XG5000

XG5000 is exclusive software to setup parameters, edit frames and diagnose communication modules of XGT series PLC and network necessary for operation of all the communication modules including FENet I/F module.

Refer to Chapter 5 XG5000 for more details.

The figure below shows the initial screen of XG5000.

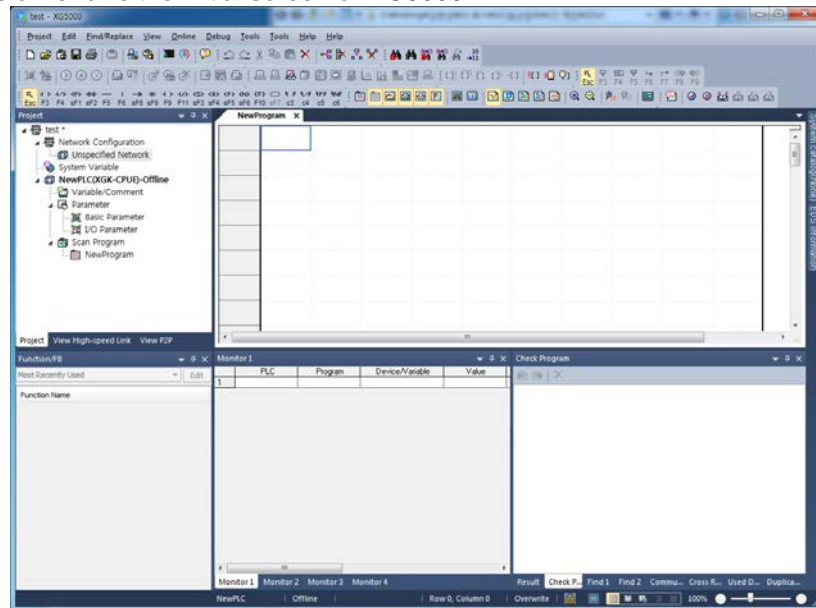

[Fig. 1.4.1] Initial screen of XG5000

### 1.4.3 Version checking

Prior to use of FENet I/F module, please check the version of the applicable module.

#### (1) Through XG5000

Connect with communication module directly via on-line so to read information of the communication module.

If interface status with CPU is normal, the information will be acquired as shown below.

- a) Execute XG5000.
- b) Use on-line connection with CPU.
- c) If connection between XG5000 and CPU is established, execute diagnosis of XG5000.
- d) On the system diagnosis screen, execute communication module status.
- e) Software information will be displayed on the right bottom of the communication module status screen.

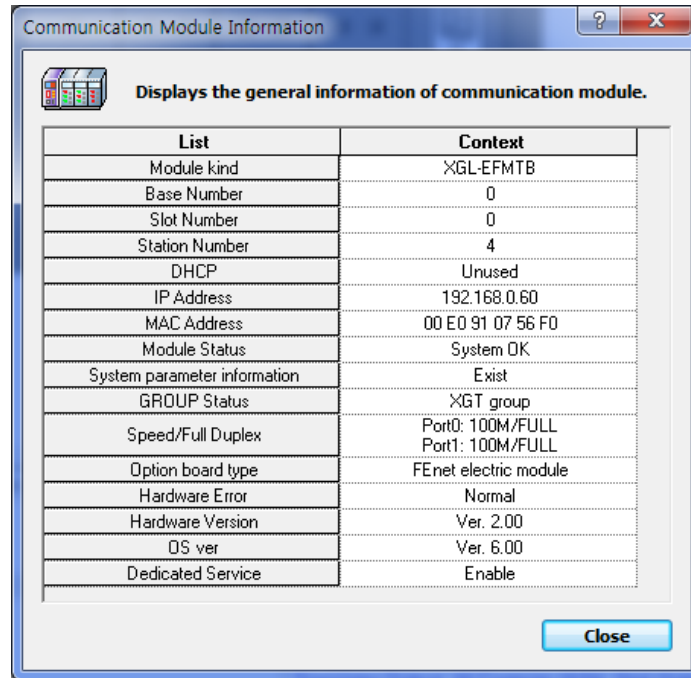

[Fig. 1.4.2] Checking module version through XG5000

## 2) Through the case label of the product

On the external case of each communication module, product information of the module is printed. The version can be checked module may be removed and then installed if on-line checking is unavailable due to unavailable external connection device with PC.

The label is adhered to the back of the product where designation and version information of the product are described.

### Chapter 2 Product Specifications

#### 2.1 General Specifications

General specifications of XGT series are as shown in Table 2.1.

No.	Items	Specification	Reference					
1	Ambient Temp.	0 ~ 55 °C						
2	Storage Temp.	-25 ~ +70 °C						
3	Ambient humidity	5 ~ 95%RH (Non-condensing)						
4	Storage humidity	5 ~ 95%RH (Non-condensing)						
5	Vibration Immunity	Occasional vibration			-	IEC61131-2		
		Frequency	Acceleration	Pulse width	Times			
		$5 \leq f < 8.4\text{Hz}$	-	3.5mm	10 times each direction (X,Y and Z)			
		$8.4 \leq f \leq 150\text{Hz}$	$9.8\text{m/s}^2(1\text{G})$	-				
		Continuous vibration						
		Frequency	Acceleration	Pulse width				
		$5 \leq f < 8.4\text{Hz}$	-	1.75mm				
$8.4 \leq f \leq 150\text{Hz}$	$4.9\text{m/s}^2(0.5\text{G})$	-						
6	Shocks Immunity	<ul style="list-style-type: none"> <li>Peak acceleration : <math>147 \text{ m/s}^2(15\text{G})</math></li> <li>Duration : 11ms</li> <li>Pulse wave type : Half-sine (3 times each direction per each axis)</li> </ul>	IEC61131-2					
7	Noise Immunity	Square wave impulse noise	AC : $\pm 1,500\text{V}$ DC : $\pm 900\text{V}$	LSIS internal test spec.				
		Electrostatic discharge	Voltage: 4kV (Contact discharge)	IEC61131-2 IEC61000-4-2				
		Radiated electromagnetic field noise	80 ~ 1000 MHz, 10V/m	IEC61131-2, IEC61000-4-3				
		Fast transient /Burst noise	<table border="1"> <tr> <td>Classification</td> <td>Power supply</td> <td>Digital/Analog Input/Output, Communication Interface</td> </tr> <tr> <td>Voltage</td> <td>2kV</td> <td>1kV</td> </tr> </table>	Classification	Power supply	Digital/Analog Input/Output, Communication Interface	Voltage	2kV
Classification	Power supply	Digital/Analog Input/Output, Communication Interface						
Voltage	2kV	1kV						
8	Operation ambience	Free from corrosive gases and excessive dust						
9	Altitude	Less than 2,000m						
10	Pollution degree	Less than 2						
11	Cooling method	Air-cooling						

#### Notes

1) IEC(International Electro technical Commission.

: An international nongovernmental organization which promotes internationally cooperated standardization in electric/electronic fields, publishes international standards and manages applicable estimation system related with.

2) Pollution level

: An index indicating pollution level of the operating environment which decides insulation performance of the devices. Generally, Pollution level 2 indicates the state that only non-conductive pollution occurs generally. However, this state contains temporary conduction due to dew produced.

**2.2 Performance Specifications**

Specifications for system configuration are as described below according to media of FEnet I/F module. Refer to the table below for system configuration.

**2.2.1 XGL-EFMT(B)/EFMF(B)**

Item		Product Name				
		XGL-EFMT	XGL-EFMTB	XGL-EFMF	XGL-EFMFB	
Transmission Specification	Baud rate	10/100Mbps	10/100/1000 Mbps	100Mbps	100/1000Mbps	
	Transmission Type	Base Band				
	Max. extended length between nodes	100m (Node-Hub)		2km		
	Max. protocol size	1,500 Byte				
	Access method to service zone	CSMA/CD				
	Frame error check	CRC 32				
Basic Specification	Current consumption (5V)	100Mbps	410 mA	560mA	630 mA	750mA*
		1Gbps	-	900mA	-	740mA*
	Weight	105 g	146 g	120 g	156 g	

\*Formerica SFP standard

[Table 2.2.1] Performance Specification of FEnet I/F module

### 2.2.2 XGL-EH5T

Item		XGL-EH5T(Switch)
Transmission Specification	Transmission speed	10/100Mbps
	Port type and number	10/100BASE-TX, TP cable, RJ-45 socket, 5 port
	Comm. Interface	Auto-Crossing, Auto-Nego.,Auto-Polirity
	Transmission length	100m
	Node interval	-
	Diagnosis	LED (PWR power, Link Status, Data)
Basic Specification	5V side consumption current (mA)	550
	Weight (g)	90

[Table 2.2.2] Performance Specification of FEnet switch module

### 2.2.3 Specification of Communication load amount

Communication load amount have two types. One is media interrupt that received every second in FEnet media, the other is the sending load amount(by link I/F) from CPU to FEnet. If exceeding FEnet granted media interrupt load amount and sending load amount, it will fail. Make network system to prevent badly intended DDOS and ARP based attack.

#### (1) Communication load amount by media interrupt

- ▶ Load by Frme from media
- ▶ Diagnose load by packet
- ▶ FEnet module's max load amount by media interrupt(Server operation standard)
  - XGL-EFMT/EFMF: about 1200 packets/sec
  - XGL-EFMTB/EFMFB: about 5,000 packets/sec
  - (5,000 packets/sec means moment load amount. For example 600 packets(or more) per 100ms makes problem)
- ▶ How to check:XG5000->[Online]-> [set communication module]-> [system diagnosis] -> [media information] -> [packet/sec]

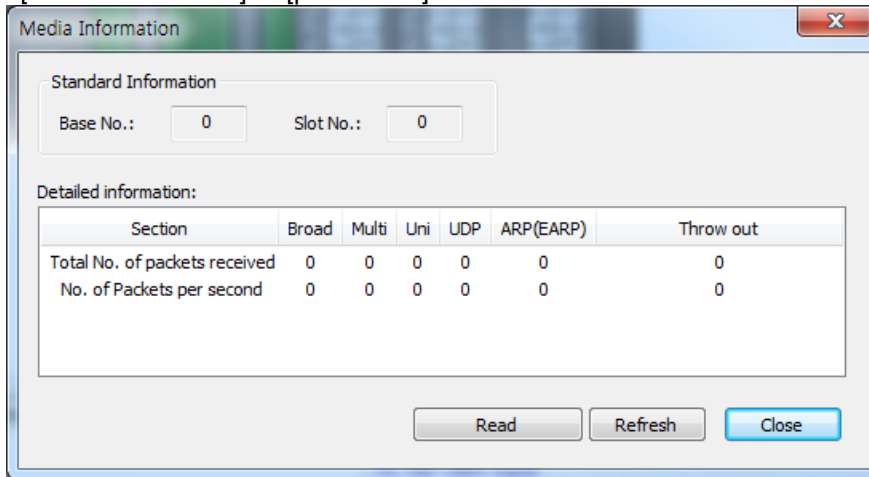

- ▶ Symptoms of FEnet module when exceeding max load amount: communication error, diagnosis service error, connection error
- ▶ If receive block is not set in high speed link parameter, interrupt still occur. It might be influenced by load amount.
- ▶ Symptoms of exceeding max load amount: set communication period in FEnet module which high speed link transmission is set longer than previous set period.  
ex)20ms → 200ms

#### (2) XGK/I/R system's send packets load (Load by link I/F interrupt)

- ▶ Load by data amount sending CPU module to Communication module
- ▶ Scan time of CPU module, high speed link service period, P2P setting will choose load amount.
- ▶ Max available sending(=transmission) block in high speed link of FEnet module considering Link I/F interrupt  

$$((\text{Sending period} / \text{Max CPU scan time}) * 8 \text{ blocks}) / 2 = \text{max sending blocks}$$
- ▶ Solution when exceeding max send/receive load: Change the RAPIenet module's sending period which high speed link set or Change number of blocks
- ▶ Max sending blocks considering CPU scan time and high speed link

## 2.3 Structure and Characteristics

### 2.3.1 Structure of XGL-EFMT(B)/EFMF(B)

#### (1) XGL-EFMT/XGL-EFMF

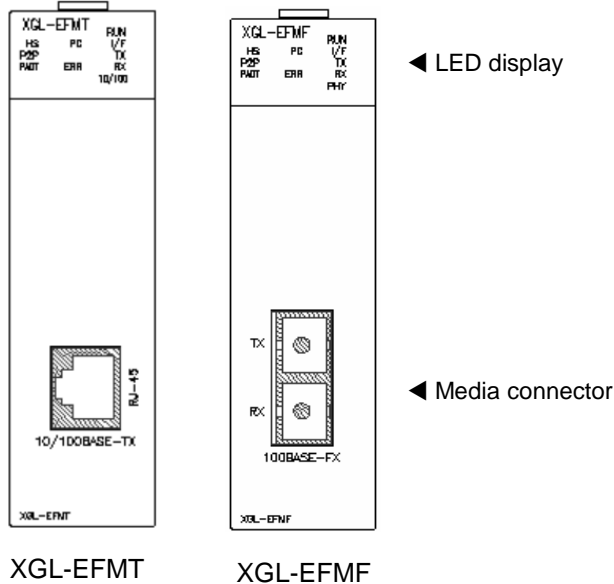

The table 2.3.1 explains the details of LED display. Refer to chapter 10 Troubleshooting of this manual for judgment and action of trouble based on the status of LEDs.

LED	Contents
RUN	Indicates whether initialization is done successfully and it works properly. In case initialization is done successfully, LED is on. In case initialization is not normal or done abnormally, LED is off.
I/F	Indicates whether FENet I/F module interface with CPU or not. In case of normal, LED flickers. In case of abnormal, LED holds on or off
HS	Indicates whether High speed link service is normal or not. In case HS link setting is done, service is enabled and service is executed normally, LED is on. Though the user sets the HS link, if the user doesn't enable the HS link service, service is not executed.

LED	Contents
P2P	Indicates whether P2P service is normal or not. In case P2P setting is done, P2P service is enabled and service is executed normally, LED is on. Though the user sets the P2P, if the user doesn't enable the P2P service, service is not executed.
PADT	Indicates whether PADT is connected or not through FEnet I/F module. If PADT is connected, LED is on. If not, LED is off.
PC	Indicates whether there's Ethernet dedicated service connection or not. If dedicated service is executed, LED is on. If not LED is off.
ERR	Indicates hardware error. It means heavy error so if this LED is on, contact custom service center.
TX	Indicates whether FEnet I/F module is transmitting or not. In case of transmission, LED is on. When transmission and stop is repeated, LED will flicker
RX	Indicates whether FEnet I/F module is receiving or not. In case of transmission, LED is on. When transmission and stop is repeated, LED will flicker
PHY	Indicates speed of media. In case of 100Mbps, LED is on. In case of 10Mbps, LED is off. When setting the media speed as Auto, the module detects the speed of media. In case the user selects the one (10Mbps or 100Mbps), that is reflected in LED

[Table 2.3.1 LEDs of XGL-EMFT/EFMF module]

(2) XGL-EFMTB/XGL-EFMFB

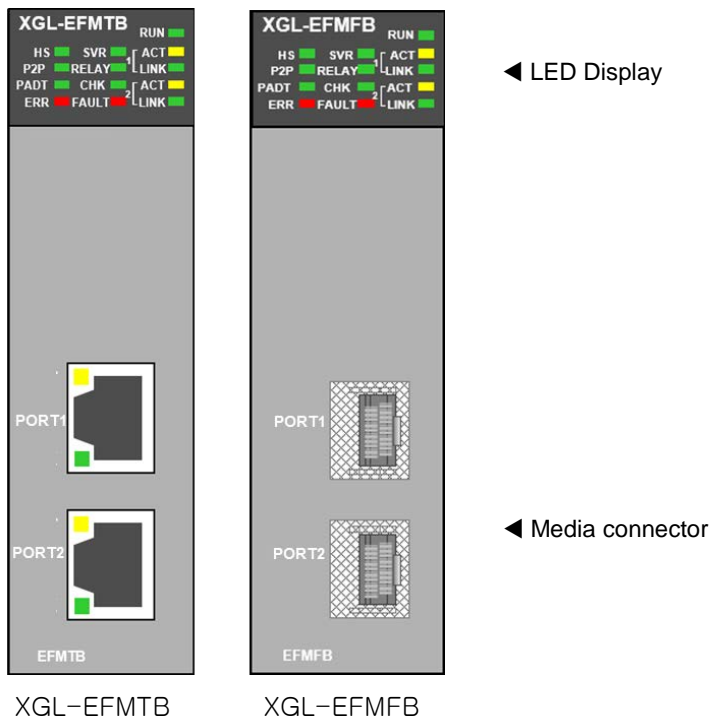

The table 2.3.2 explains the details of LED display. Refer to chapter 10 Troubleshooting of this manual for judgment and action of trouble based on the status of LEDs.

## Chapter 2 Product Specifications

LED	Contents
RUN	Indicates whether initialization is done successfully and it works properly. In case initialization is done successfully, LED is on. In case initialization is not normal or done abnormally, LED is off.
HS	Indicates whether High speed link service is normal or not. In case HS link setting is done, service is enabled and service is executed normally, LED is on. Though the user sets the HS link, if the user doesn't enable the HS link service, service is not executed.
P2P	Indicates whether P2P service is normal or not. In case P2P setting is done, P2P service is enabled and service is executed normally, LED is on. Though the user sets the P2P, if the user doesn't enable the P2P service, service is not executed.
PADT	Indicates whether PADT is connected or not through FENet I/F module. If PADT is connected, LED is on. If not, LED is off.
SVR	Indicate whether connection with remote Ethernet interface communication device(include PC) and dedicated communication service. In case dedicated communication is used, LED is on.
ERR	Indicates hardware error. It means heavy error so if this LED is on, contact custom service center.
RELAY	<p>If the Relay option of the basic parameter is checked, it turns ON when the media speed of Port 1 and Port 2 is the same and the frame can be relayed.</p> <p>In V6.0 or above, Relay LED will blink if the media speed is different between the two ports even if the Relay option is checked.</p> <p>* Relay function is not supported at 10Mbps, so if Relay option is checked at 10Mbps, Relay LED will be off.</p>
CHK	<ol style="list-style-type: none"> <li>1. LED is OFF: normal operation</li> <li>2. LED is ON <ul style="list-style-type: none"> <li>- If there is no basic parameter</li> <li>- If there is an error in the basic parameter (when the module type is different)</li> <li>- There is an error in the basic parameters (when the media type and the type of the installed media are different)</li> <li>- If there is an error in the basic parameter (if there is an error in the IP setting)</li> <li>- If there is an error in the RAPIEnet slave parameter (V6.0 or above)</li> <li>- When there is a station number duplicated on the RAPIEnet network. (Not a collision of the local station number) (V6.0 or above)</li> </ul> </li> <li>3. Blinking <ul style="list-style-type: none"> <li>- During Flash Write. (V6.0 or above)</li> <li>- When the RAPIEnet network is changed to Ring -&gt; Line (250ms On, 250ms Off) (V6.0 or above)</li> <li>- When discarding received messages due to heavy load (V6.0 or above)</li> </ul> </li> </ol>
FAULT	<ol style="list-style-type: none"> <li>1. LED is OFF: normal operation</li> <li>2. LED is ON <ul style="list-style-type: none"> <li>- If RAPIEnet is set and a RAPIEnet station number is duplicated (V6.0 or above)</li> <li>- IP conflict occurs.</li> <li>- While erasing flash</li> </ul> </li> <li>3. Blinking <ul style="list-style-type: none"> <li>- If there is an error in the communication frame (CRC error and other errors)</li> <li>- When an error occurs in the slave during RAPIEnet slave control</li> </ul> </li> </ol>
ACT	In case Ethernet I/F module send and receive data, LED is on. In case send and stop send operations are repeat, LED is flickering.
LNK	In case Ethernet I/F module connect link with network, LED is on

[Table 2.3.2 LEDs of XGL-EFMTB/EFMFB module]

2.3.2 Structure of XGL-EH5T module

(1) XGL-EH5T

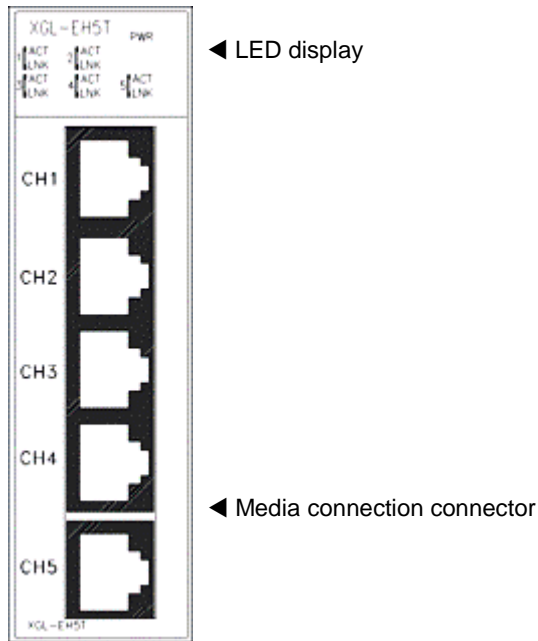

XGL-EH5T

Special setting is not necessary and this module gets the power from power. If all LEDs except power LED flicker one time after power on, switch module is normal.

LED description of XGL-EH5T

LED status		Off	Flicker	ON
PWR		Power is OFF	-	Power is ON
1	ACT	Not Sending/Receiving data	Sending/Receiving data	-
	LNK	10Mbps Link	-	100Mbps Link
2	ACT	Not Sending/Receiving data	Sending/Receiving data	-
	LNK	10Mbps Link	-	100Mbps Link
3	ACT	Not Sending/Receiving data	Sending/Receiving data	-
	LNK	10Mbps Link	-	100Mbps Link
4	ACT	Not Sending/Receiving data	Sending/Receiving data	-
	LNK	10Mbps Link	-	100Mbps Link
5	ACT	Not Sending/Receiving data	Sending/Receiving data	-
	LNK	10Mbps Link	-	100Mbps Link

**2.4 Cable Specifications**

**2.4.1 UTP cable**

UTP cable is classified into 2 types based on the following criteria.

- ① Shield: classified into 3 (UTP, FTP, STP)
- ② Frequency band used: classified into 7 (Cat.1~7)

1) Type of cables (shield)

Classification	Details	Purpose
UTP (or U.UTP)	Unshielded cable. High speed data transmission.	Max. 200MHz Phonetic+Data+Low grade of video signal
FTP (or S.UTP)	Shielded cable core only.	Max.100MHz Electronic impediment (EMI) and electric stability considered Phonetic+Data+Low grade of video signal
STP (or S.STP)	Double-shielded cable. Shielded core and Individually Pair cable	Max. 500MHz Phonetic+Data+Video signal Substitute for 75Ω coaxial cable

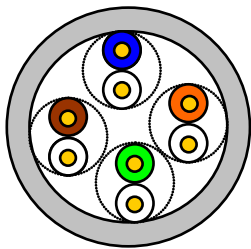

UTP

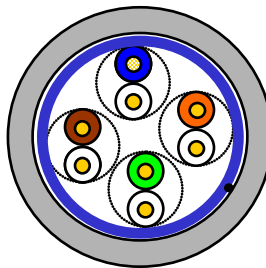

FTP

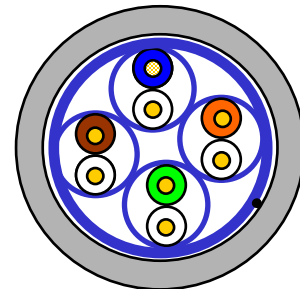

STP

**Notes**

1) UTP : Unshielded Twisted Paired Copper Cable

FTP : (Overall) Foiled Twisted Paired Copper Cable

STP : (Overall) Shielded(and Shielded Individually Pair)Twisted Paired Copper Cable

2) Patch Cable(or Patch Cord)

Conductor composed of stranded cable instead of solid conductor may be used to increase the flexibility of UTP 4-pair cable. And surface specification and materials used is Un-coated AWG 24 (7/0203A).

In other words, the diameter of a single cable is 0.203mm, and this cable is of 1+6 structure as standardized with annealed copper cable.

3) It is recommended to use S,STP cable in PLC Ethernet. If it's not possible because of field conditions, error (communication error and module error by noise) might occur.

2) Classification based on frequency used

Classification	Frequency used (MHz)	Transmission Speed (Mbps)	Purpose
Category 1	Phonetic Frequency	1	Phone network (2-Pair)
Category 2	4	4	Multi-Pair communication cable
Category 3	16	16	Phone network + Computer network
Category 4	20	20	1) Computer network transmission speed Up 2) Low-loss communication cable
Category 5 and Enhanced Category 5	100	100	1) Digital Phone network + Computer network 2) Low-loss, broadband cable
Category 6 Category 6A	250 500	1000 10000	-
Category 7 Category 7A	600 1000	10000 10000	-

Notes
1) Presently classified items are Category 3, 5, En-Cat.5 and Cat.6 inside and outside of the country, where Category 4 has been replaced by Category 5 and Category 7 is being under development all over the world as STP structure.

3) Example (CTP-LAN5) of Category 5 twisted-pair cable (UTP)

Item	Unit		Value
Conductor resistance(Max)	$\Omega$ /km		93.5
Insulation resistance(Min)	M $\Omega$ -km		2,500
Voltage endurance	V/min		AC 500
Characteristic impedance	$\Omega$ (1~100MHz)		100 $\pm$ 15
Attenuation	dB/100m or less	10MHz	6.5
		16MHz	8.2
		20MHz	9.3
Near-end crosstalk Attenuation	dB/100m or less	10MHz	47
		16MHz	44
		20MHz	42

### 2.4.2 Optical cable

Item	Value
Cable Type	Twin strands of multi-mode fiber optic cable(MMF)
Connector	XGL-EFMF: SC type connector XGL-EFMFB: LC type connector
Diameter of optical fiber	62.5/125 $\mu$ m (62.5 $\mu$ m fiber optic core and 125 $\mu$ m outer cladding)
Wavelength used	1,310 nm
Attenuation	2dB/1,000m or less
Near-end crosstalk Attenuation	11dB or less

#### Notes

- 1) Since the type of the connectable cable used for communication module differs from each other based on the system configuration and its environment, applicable professional advice will be required prior to installation.
- 2) The optical cable may have communication errors due to attenuation if any fingerprint or contamination is stuck on the sectional end of the cable during its treatment.

# Chapter 3 Installation and Operation

## 3.1 Precautions for Installation

### 3.1.1 Installation

#### (1) For system configuration through FEnet I/F module

- 1) Check the basic factors necessary for system configuration so to select an appropriate communication module.
- 2) Select the cable to be used for communication module to use. (only one is available between 10/100 BASE-TX and 100BASE-FX).
- 3) Before installing communication module, check if there is no foreign element on the connector of base and module, and no damage on the connector pin of the module.
- 4) All kinds of communication modules can be installed on the extension base fundamentally, however, it is recommended to install communication modules on the slot as near as possible to CPU.
- 5) For installation of the module, exactly insert the protuberant part at the bottom of the module with the communication cable disconnected into the base groove and then apply enough strength until its top is locked up with the locking device of the base. If the lock is not applied, it may cause an error on the interface with CPU.
- 6) The cable available for the communication module shall be installed with one type only between 10/ 100BASE-TX and 100BASE-FX.
- 7) Select standard products of switching hub and cable, which are necessary for communication with FEnet I/F module.

#### (2) For system configuration through switch module

- 1) Check the foreign substance at the connector and damage of connector pin
- 2) This module gets power from base so this module is not recognized by CPU. This module can be installed on any base. (main or extension)
- 3) For installation of the module, exactly insert the protuberant part at the bottom of the module with the communication cable disconnected into the base groove and then apply enough strength until its top is locked up with the locking device of the base. If the lock is not applied, it may cause detachment.
- 4) 10/100BASE-TX can be applied to this switch module.

### 3.1.2 Operation steps

The steps for operating FEnet I/F module from installation to operation will be described below. After the product installation is complete, install and configure the system to be operated as specified in the following steps.

Operation Steps.

- 1) Install FEnet I/F module on the base
- 2) Connect FEnet I/F module with other network.
- 3) Turn the system power on
- 4) Run XG5000 to setup basic parameters.
- 5) After the basic parameters are downloaded, reset the module.
- 6) After the module reset, check if RUN and I/F RUN LEDs of the module are normal.
- 7) If LED and CPU are normal, check the status information of the communication module and CPU with the diagnosis function of XG5000.
- 8) If the module status is normal, check if response comes in when PING test is executed through a computer connected to the network if a computer is connected to the network. If computer is not connected to the network, use the live check item among diagnosis services of XG5000 to check the response.
- 9) Setup the communication services and download the setup items to the PLC with XG5000.
- 10) Enable communication service.
- 11) After programming with XG5000, write it on CPU to start the operation.

#### Notes

- 1) After station No. and IP address are specified through XG5000, surely reset the applicable module. The first station No. and IP address (including frames) will keep the value read from the communication module when initialized. Any changed details during communication will not be applied during Run.

**3.2 Installation of the Product**

**3.2.1 Installation of XGL-EFMT(B)**

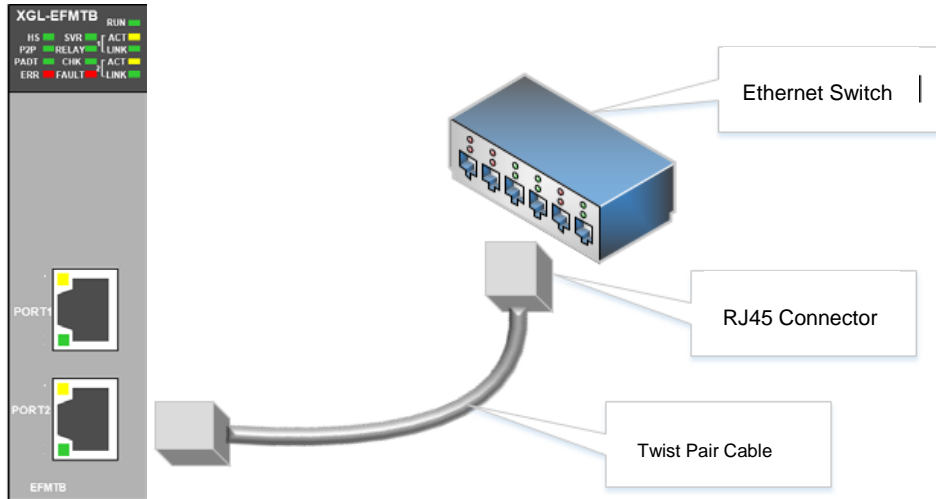

[Fig. 3.2.1] Installation of XGL-EFMT(B)

The maximum cable length of a segment in 10/100BASE-TX system is 100m (distance between module and hub). Generally, the hub is of straight cable with TD and RD stranded inside. If only 2 communication modules are connected 1 to 1, cross-cable form shall be used.

Pin No.	Sign	Straight cable between hub and module	1 to 1 cross-cable
1	TD+	1 — 1	1 — 3
2	TD-	2 — 2	2 — 6
3	RD+	3 — 3	3 — 1
6	TRD2+	4 — 4	4 — 7
4	TRD2-	5 — 5	5 — 8
5	RD-	6 — 6	6 — 2
7	TRD3+	7 — 7	7 — 4
8	TRD3-	8 — 8	8 — 5

### Notes

- 1) Since the structure of 10/100BASE-TX cable is vulnerable to external noise, the cable needs to be stranded as twisted (two lines twisted with each other) between cables of the pin No.1 and 2 of TD+ and TD- and between cables of the pin No.3 and 6 of RD+ and RD- so to be strong against noise
- 2) Hub power shall be separated from PLC power to be used against the noise.
- 3) Contact professional manufacturers for processing cable terminal, manufacture and installation.

### (1) Precautions for UTP installation

- 1) In order to transmit reliable 100Mbps sign with UTP cable, use the cable conforming to the characteristics of Category 5.
- 2) Be careful not to exceed the tension strength of the cable intensely during wiring.
- 3) When escaping from the coat (sheathed), let it as long as the length only to be wired and with the insulation kept from damage.
- 4) Jumper wire and patch code shall be applied rather loosely. If wired too tight, the characteristics of Category 5 may be deteriorated.
- 5) When UTP cable is installed, a suitable distance shall be maintained between EMI source and UTP cable.

Condition	Min. separation distance		
	2.0 kVA or less	2.5 kVA	5.0 kVA or more
Power line unshielded, or electric facility open or near to nonmetallic pipe	127mm	305mm	610mm
Power line unshielded, or electric facility near to metallic pipe buried	64mm	152mm	305mm
Power line inside metallic pipe buried (or equivalently shielded) near to metallic pipe buried	-	76mm	152mm
Transformer, electric motor, fluorescent lamp	1,016mm 305mm		

### Notes

- 1) If voltage is 480V, rated power is 5 kVA or more, separate calculation is needed.

### 3.2.2 Installation of XGL-EFMF(B)

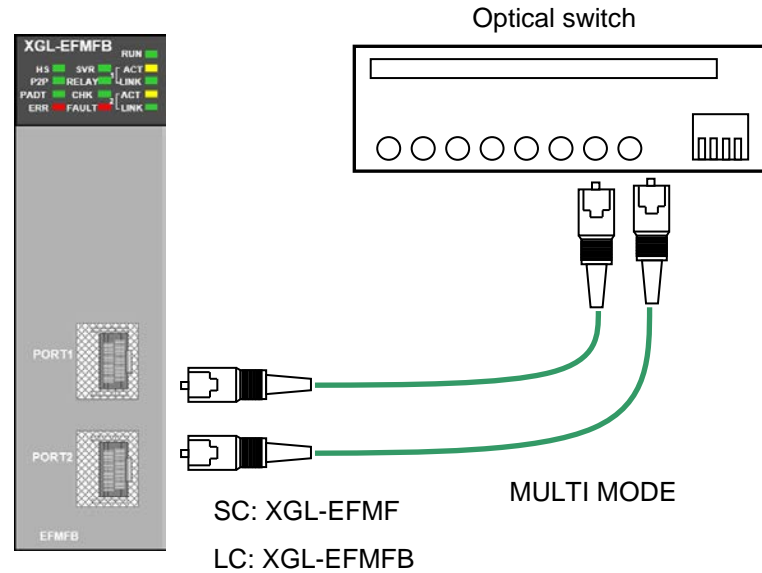

[Fig. 3.2.2] Installation of XGL-EFMF(B)

The maximum cable length of segment in 100BASE-FX system is 2km (distance between module and optical switch). In case of XGL-EFMF(B), refer to SFP specification. Let the module's Tx cross-connected with the optical switch's Rx, and the module's Rx with the optical switch's Tx.

#### Notes

1) Since the optical cable is vulnerable to impact, pressure, folding and pulling, pay good attention to its treatment.

The optical contact between the connector and the end of the cable may have communication errors if contaminated, which may result in unavailable communication.

If the cable is installed outdoors, additional countermeasures are required to protect the cable suitably for the installation environment.

### 3.2.3 Installation of XGL-EH5T

This switch module provides interface used between Ethernet module using 10/100BASE-TX. So interfaces between PCs are also supported.

Twist Pair Cable

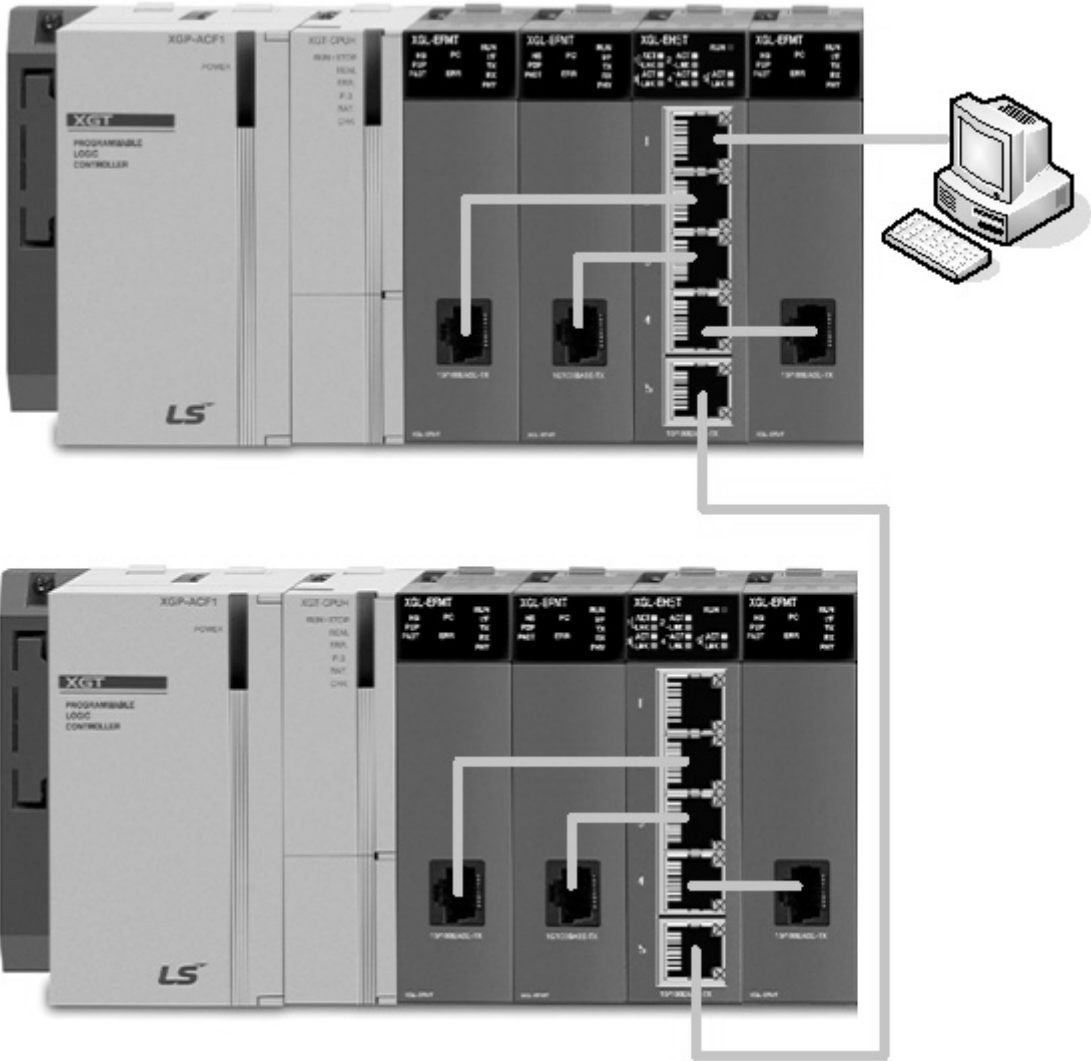

[Figure 3.2.3] Installation of XGL-EH5T

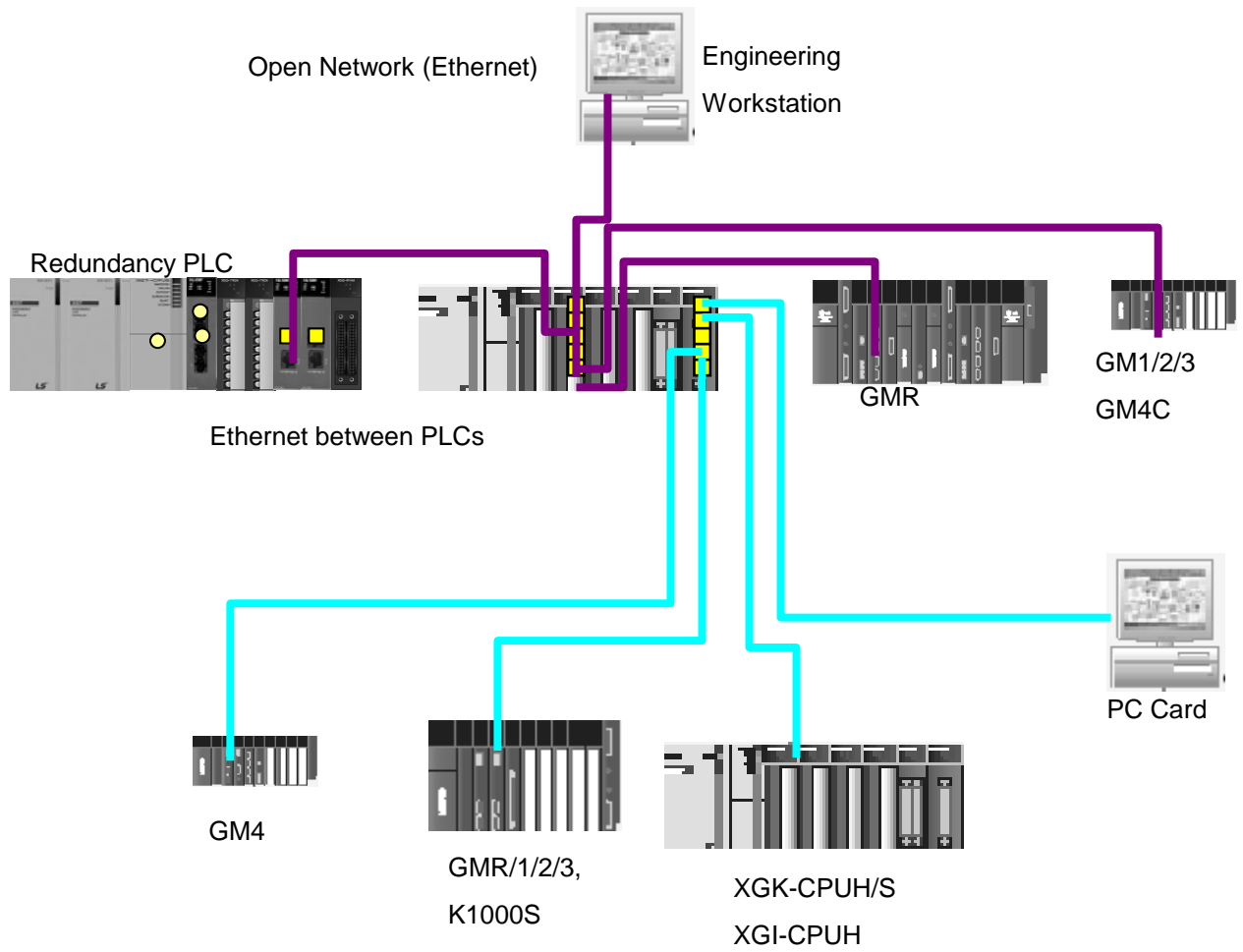

[Figure 3.2.4] System configuration example using XGL-EH5T

## (1) Installation of cable

XGL-EH5T uses UTP cable that is same one used in XGL-EFMT. For more detail, refer to 3.2.1. This switch module provides Auto Cross Over function so the user can use both cross and direct cable.

## **3.3 Operation**

Check status of LEDs of FEnet I/F module when power turned on after communication cable is connected. If normal, download the applicable program to PLC via XG5000 so to execute the program.

### **3.3.1 Precautions for system configuration**

- 1) IP addresses shall be surely different from each devices in 1 network system including FEnet I/F module. If there are more than 1 devices of same IP address in 1 network system, communication error may occur, leading to communication trouble. HS link station No. of all stations also shall be different from each FEnet I/F module to use HS link service.
- 2) Use the communication cable as specified only. If not, fatal error may occur to communication.
- 3) Check communication cable if opened or shorted prior to installation.
- 4) Tighten up communication cable connector until connected firmly. If cable connection is unstable, fatal error may occur to communication.
- 5) If cable is connected long distance, keep the cable far away from power line or inductive noise.
- 6) Since the flexibility of coaxial cable is low, it is to be diverged min. 30cm away from the connector in communication module. If the cable is bent at a right angle or transformed compulsorily, cable disconnection or connector damage in communication module may be caused.
- 7) If the status of LEDs is abnormal, refer to Chapter 10 Troubleshooting to check for causes and available actions against the status of LEDs. Contact customer service center if the error is as before

### **3.3.2 Checklist prior to test operation**

Check items are described below prior to operation of the FEnet I/F module.

#### 1) Communication module installed on PLC

Check items	Description
Installation and inspection of basic S/W	- Is installation and operation of XG5000 normal?
Communication cable connection (If cable is connected)	- Is connection and tab status of communication cable normal? - Is the status of LEDs and cable connection normal?
Module installation	- Is the FEnet I/F module installed correctly on basic base?

### 2) Steps of operation

The steps will be described below, starting from installation complete on PLC to test operation

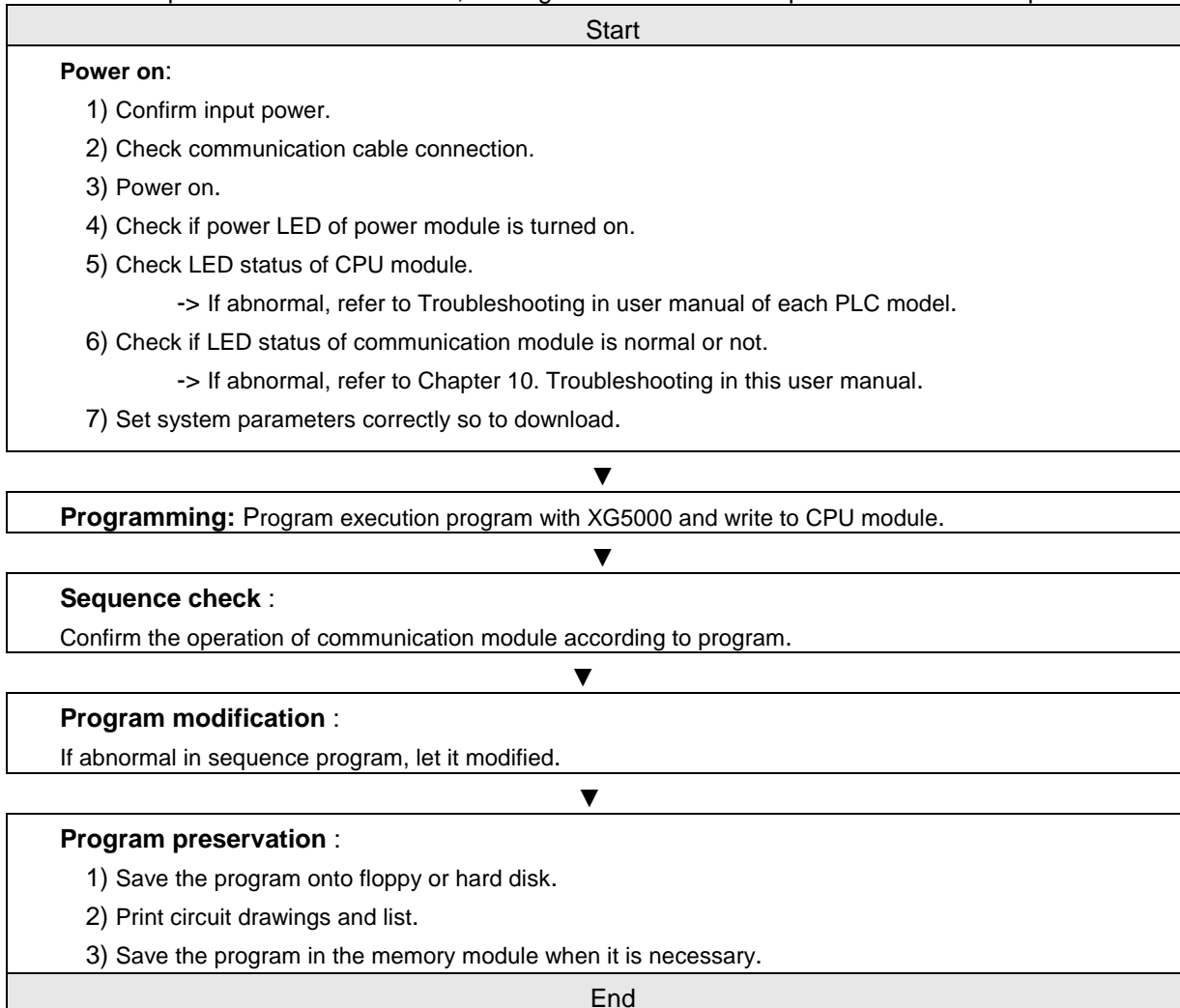

### 3.3.3 How to install or remove the module

Follow the steps described below to replace or remove the applicable module due to its hardware error or system change.

- (1) To replace the communication module
  - (1) Power off the base where the communication module is installed on.
  - (2) Disconnect the network cable.
  - (3) Install a new module as specified in the steps of 3.3.2 above.
- (2) Replacement by the module change switch of CPU  
Refer to how to use the module exchange switch of CPU
- (3) Replacement by the module wizard switch of XG5000  
Refer to how to use the module change wizard of XG5000

#### Notes

- 1) When FEnet I/F module is replaced, reset the opposite side device (MMI or PC). The device may stop communicating due to the time out of the applicable module

## Chapter 4 System Configuration

### 4.1 Configuration of Network System

#### 4.1.1 LSIS' PLCs Ethernet system

LSIS's Ethernet system can connect to Internet public network using open protocol TCP/IP. So you can monitor local PLC via broadband monitoring system[1,2], GLOFA VIEW using Internet. And you can monitor PLC via local monitoring system connected to local network.

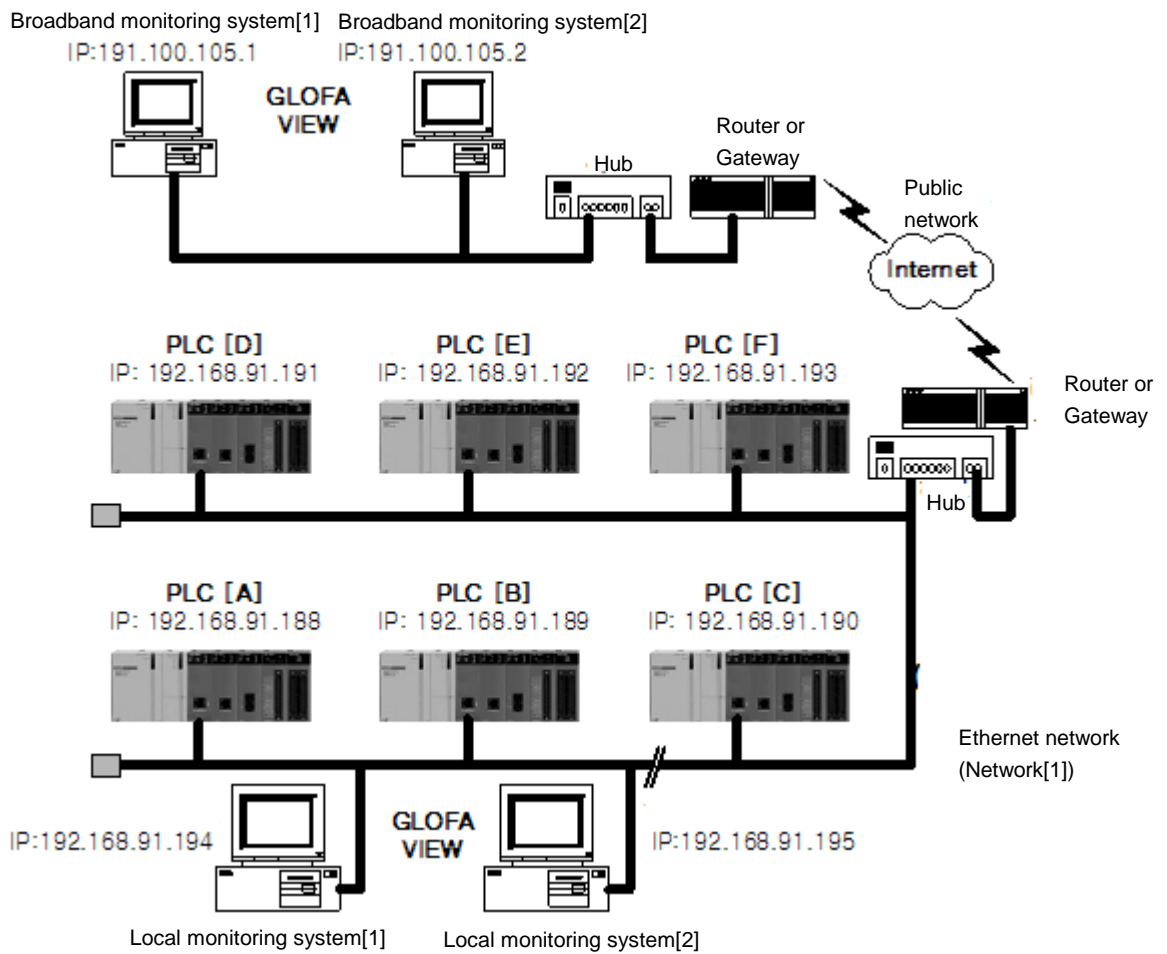

[Fig.4.1.1] Ethernet System [Public network with LSIS' PLCs]

### 4.1.2 Dedicated Network composed of LSIS' PLCs

You can configure Ethernet system with dedicated network not connected to public network, Internet. Figure 4.1.2 shows example using dedicated network. Each PLC is connected to the dedicated Ethernet network via FEnet module and they can transmit and receive each other's data using P2P, High Speed Link and the dedicated service.

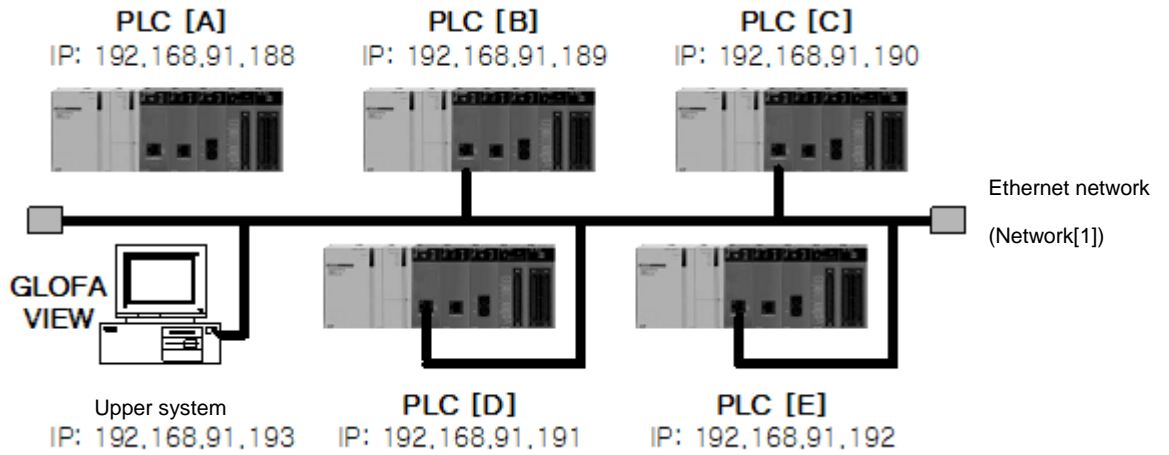

[Fig.4.1.2] Ethernet System (Dedicated Network with LSIS' PLCs)

### 4.1.3 Dedicated Network composed of LSIS' and Other Company's PLCs

Figure 4.1.3 shows Ethernet system composed of LSIS's and other company's PLCs. LSIS's PLC can use user-defined communication. So if you know the frame structure of other company's PLCs, LSIS's PLC can communicate with other PLC.

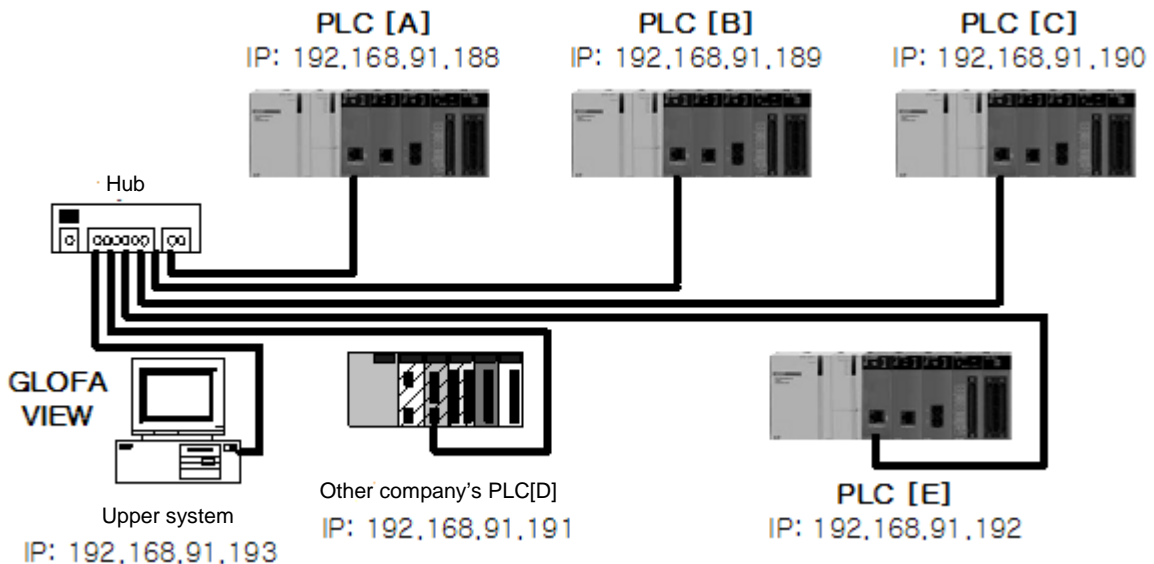

[Fig.4.1.3] Ethernet System (Dedicated Network with LSIS' and Other Company's PLCs)

### 4.1.4 Public Network and Dedicated Network system

LSIS's Ethernet system can connect to Internet public network using open protocol TCP/IP. So you can monitor local PLC via broadband monitoring system[1,2], GLOFA VIEW using Internet. And you can monitor PLC via local monitoring system connected to local network.

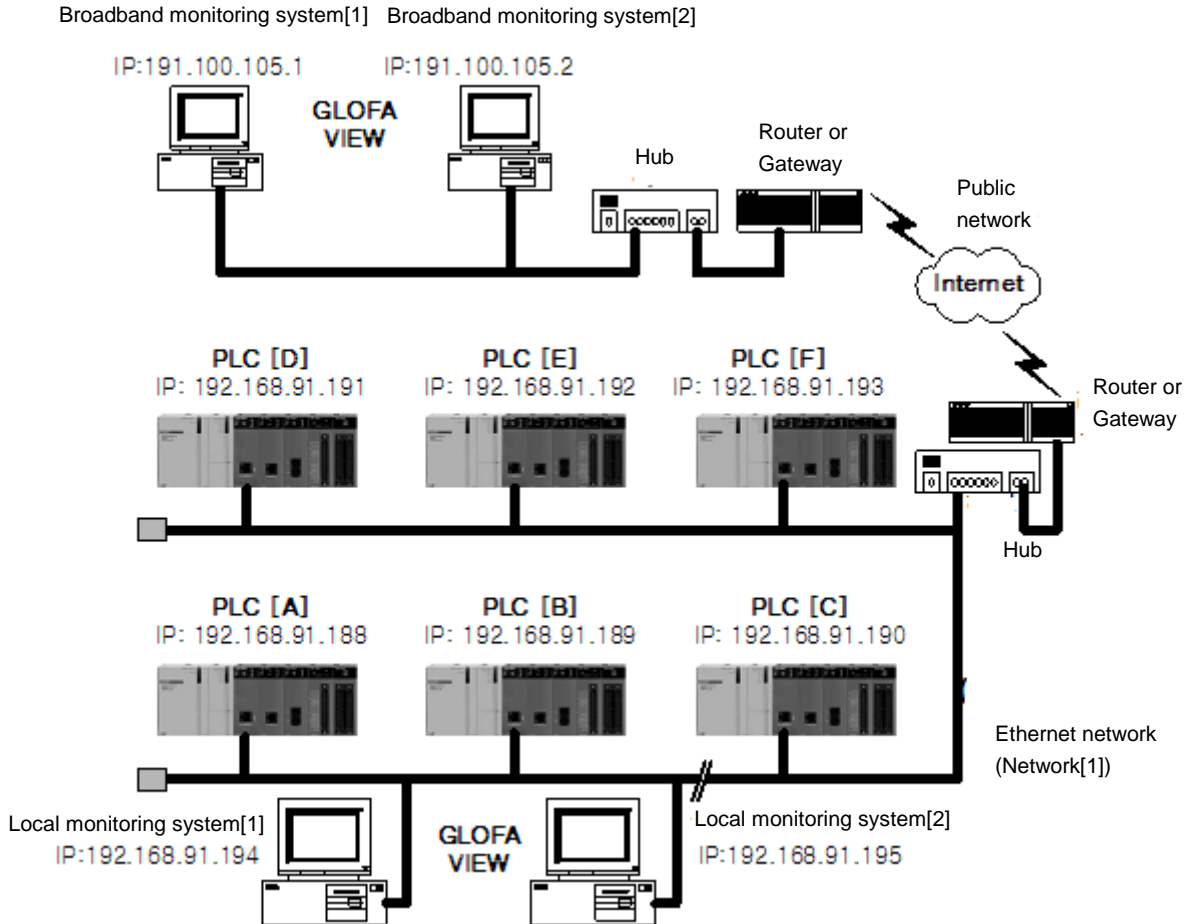

[Fig.4.1.4] Ethernet System (Public Network + Dedicated Network)

**4.1.5 Public Network and Dedicated Network system composed of LSIS' and other company's PLCs**

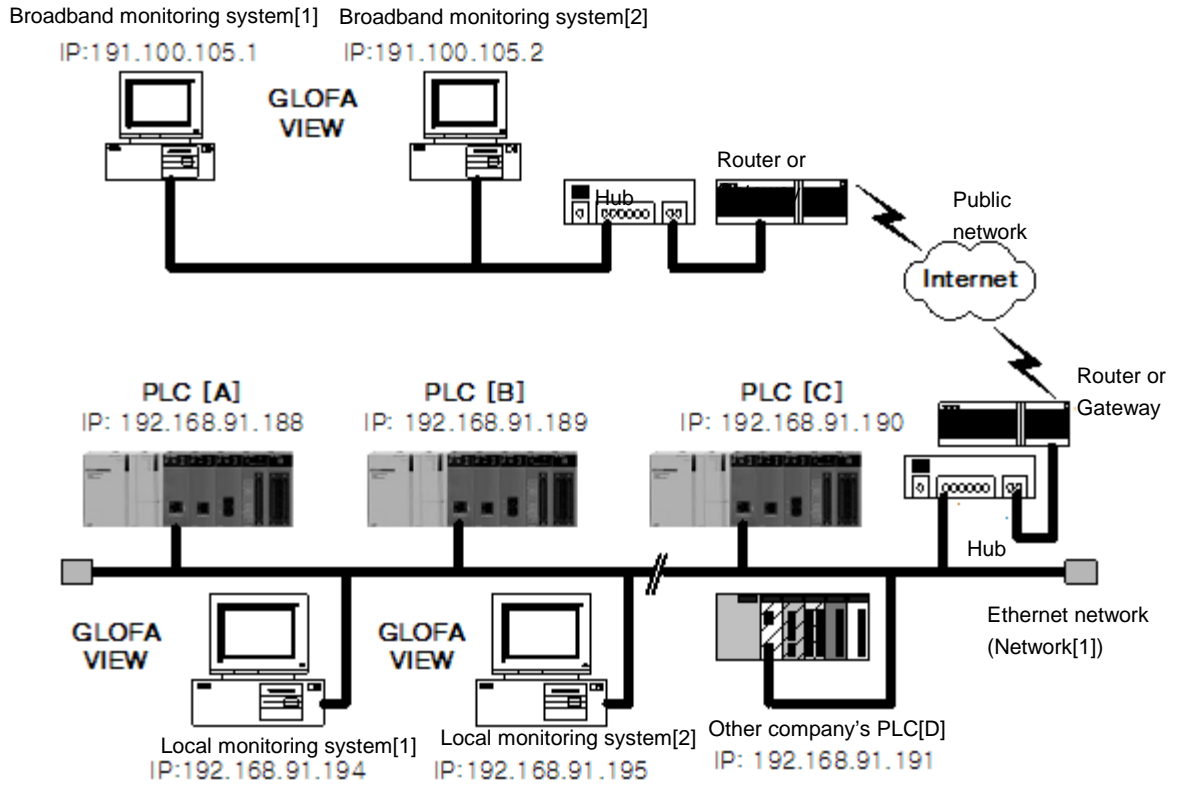

[Fig.4.1.5] Ethernet System (Public Network + Dedicated Network + Other Company's System)

**4.1.6 System configuration using dedicated Ethernet between HMIs, PLCs at XGR system**

At XGR system, Ethernet module should be installed at main base and same slot of A/B bases. Ethernet module installed at base acting as MASTER executes the communication service but Ethernet module installed at base acting as STANDBY CPU doesn't execute the communication service.

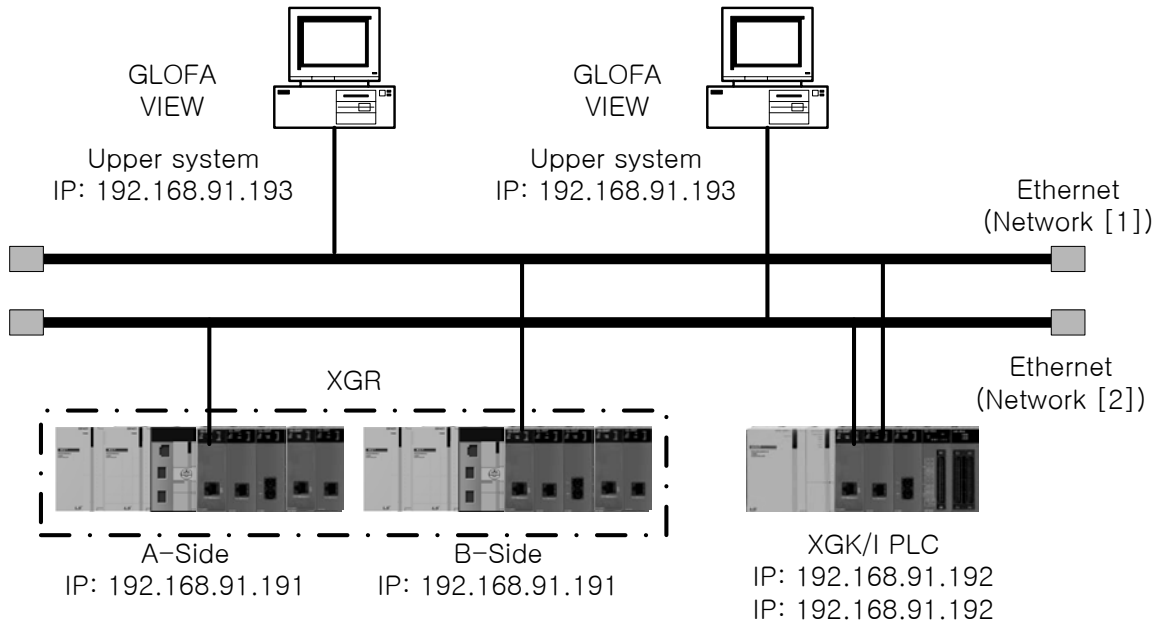

[Figure 4.1.6] XGT Ethernet redundancy system (Redundant Network)

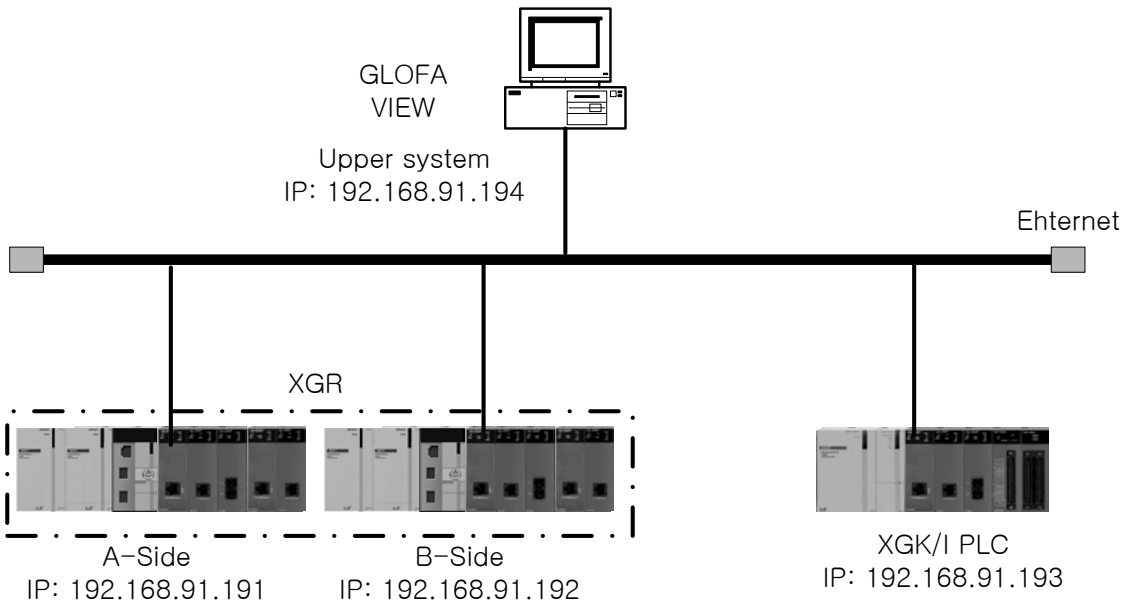

[Figure 4.1.7] Communication as XGT redundant system (Single network)

**4.1.7 System configuration using dedicated Ethernet between HMIs, PLCs at XGR system**

For communication with upper system, previous PLC system and other company's controller, Ethernet communication module can be used and For communication with XGT PLC, industrial Ethernet communication can be used to improve the reliability and speed.

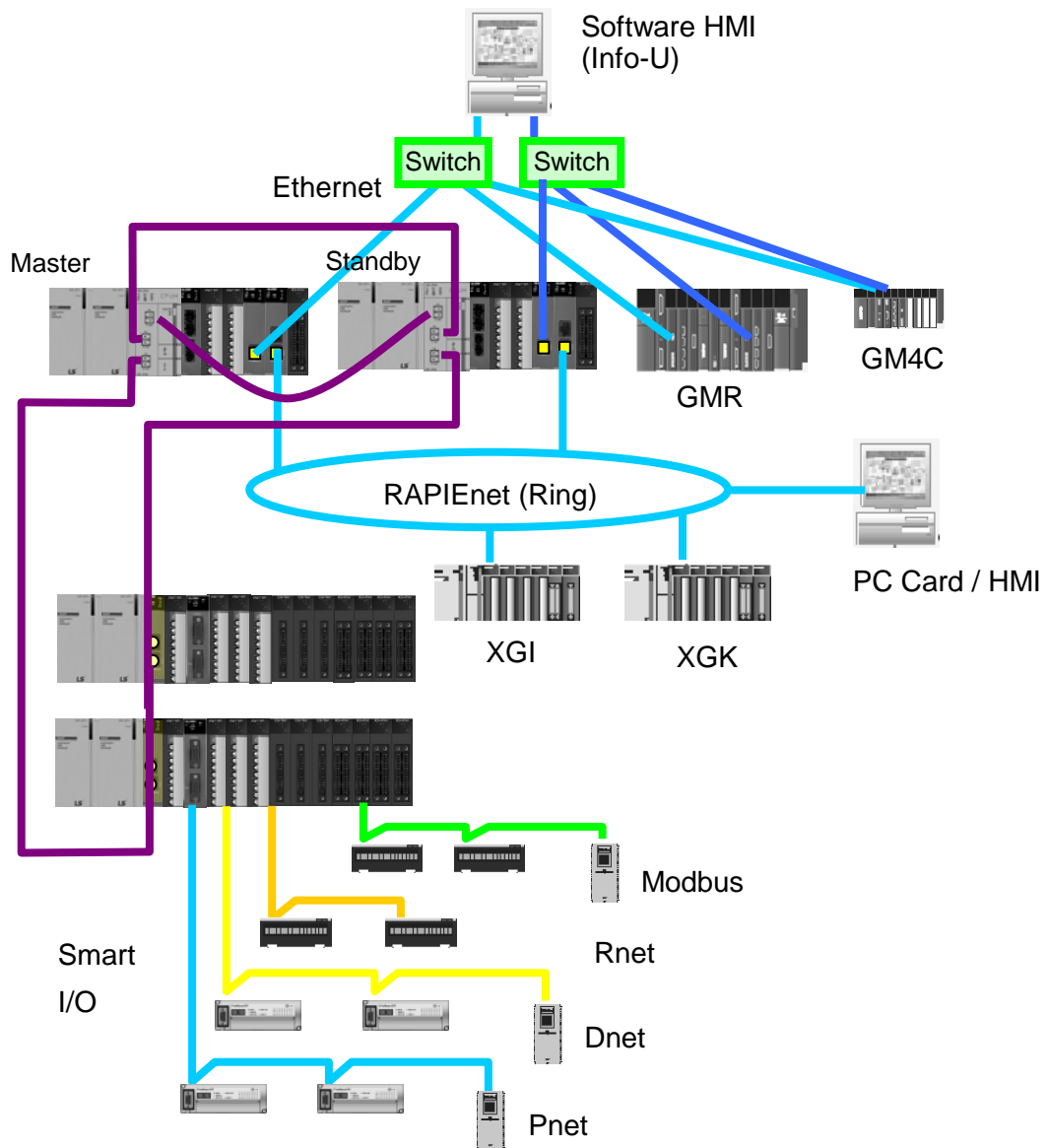

[Figure 4.1.8] XGT redundancy system (Between HMIs, PLCs)

### 4.1.8 Ethernet, RAPIEnet mixed system configuration through MRS (FEnet V6.0 or above and MRS V1.1 or above)

higher level system can be used for Ethernet for devices that require compatibility, such as third-party systems. Ring configuration and communication with Smart I / O can be connected using RAPIEnet protocol.

- (1) It is possible to configure various system types by using single type MRS. (Compatibility between RAPIEnet)

 RAPIEnet

1) 2 Ring System (Ring to Ring)

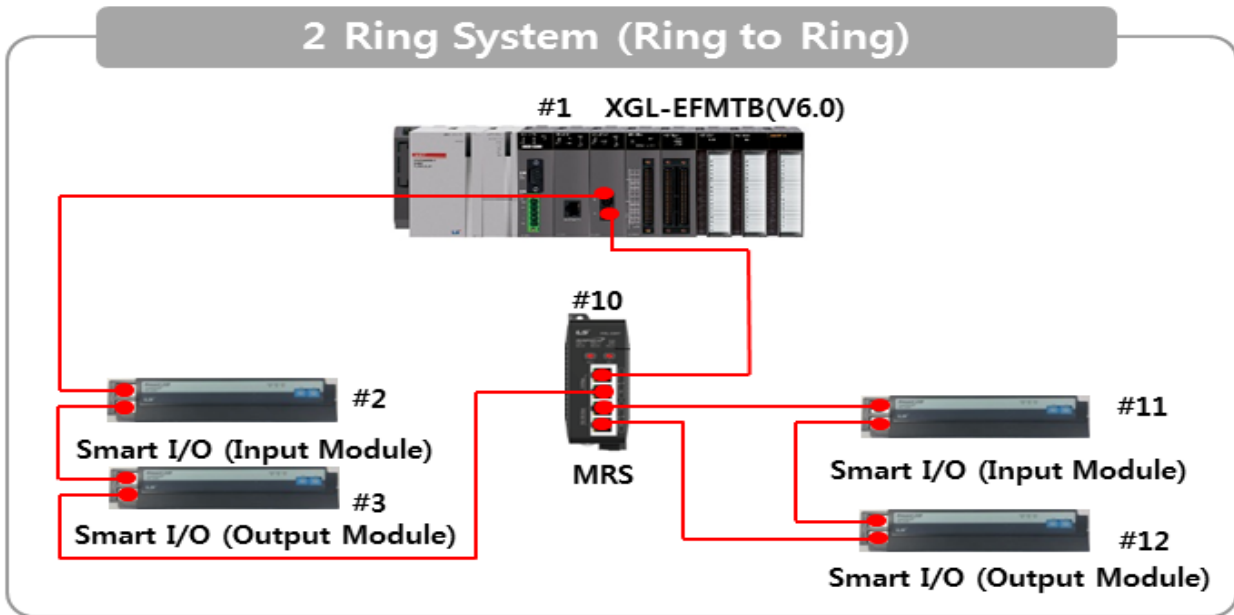

2) 1 Ring/ 1Line System (Ring to Line)

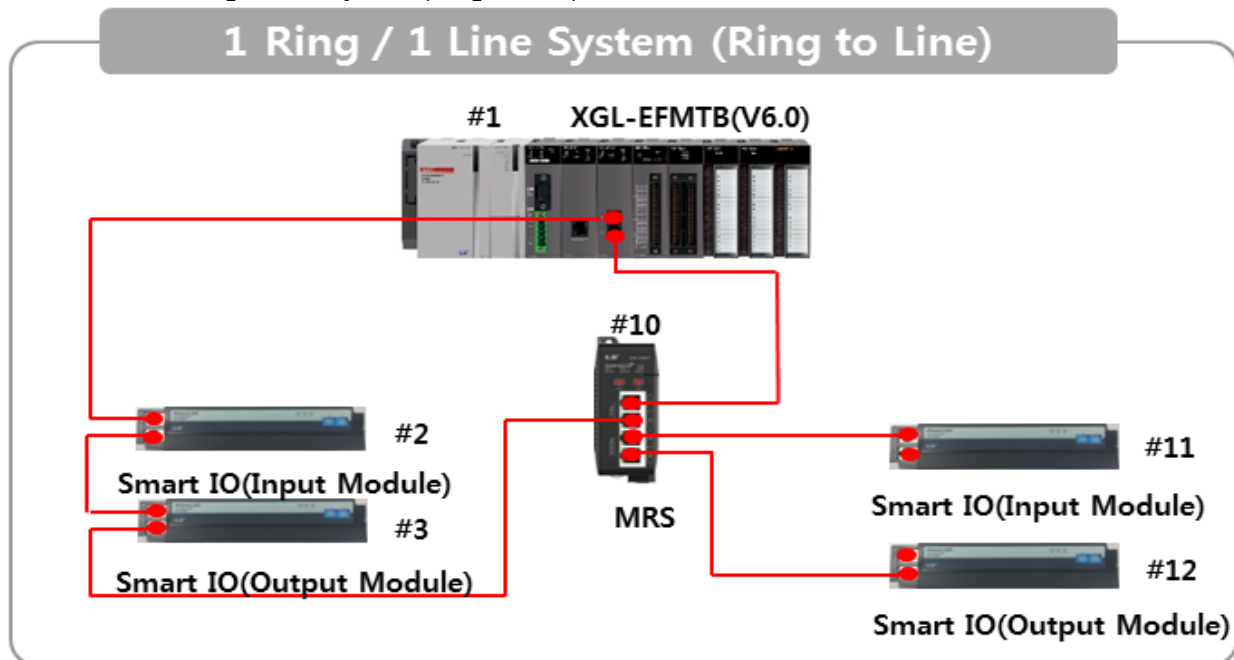

3) 2 Line System (Line to Line)

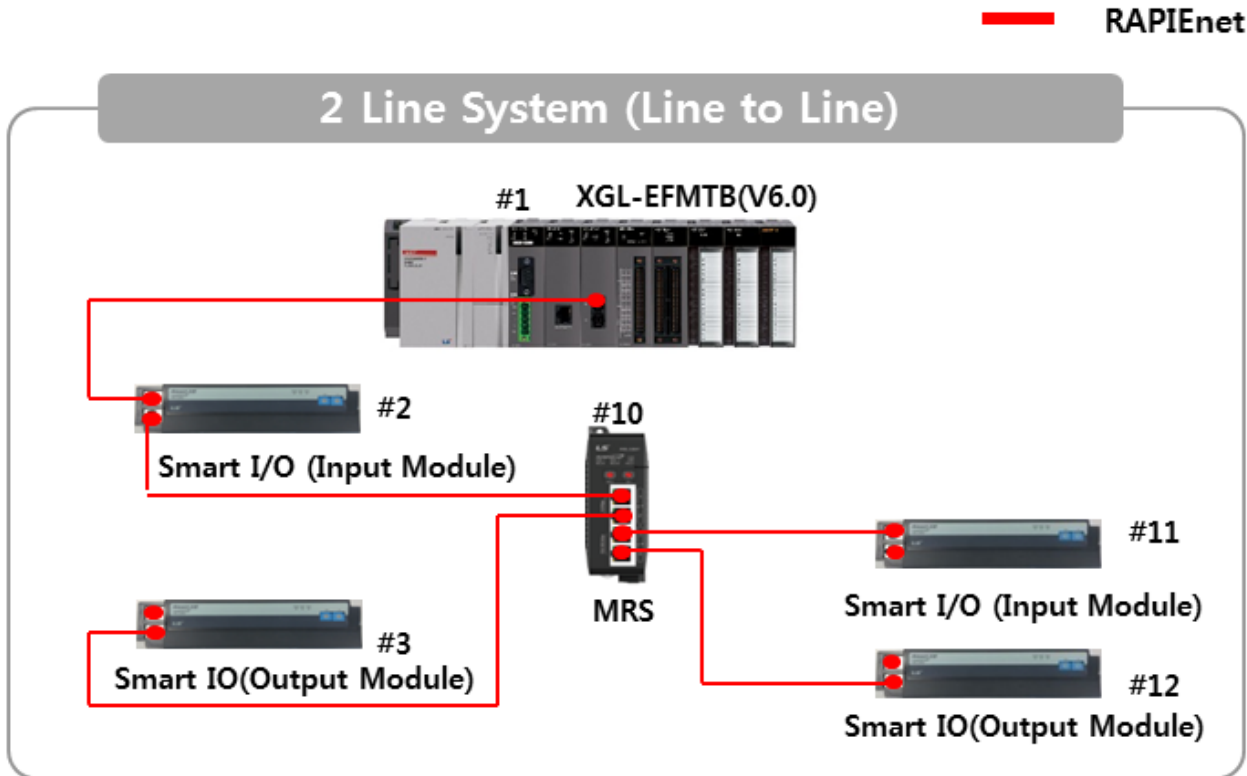

4) 1 Line / 1 Ring System (Line to Ring)

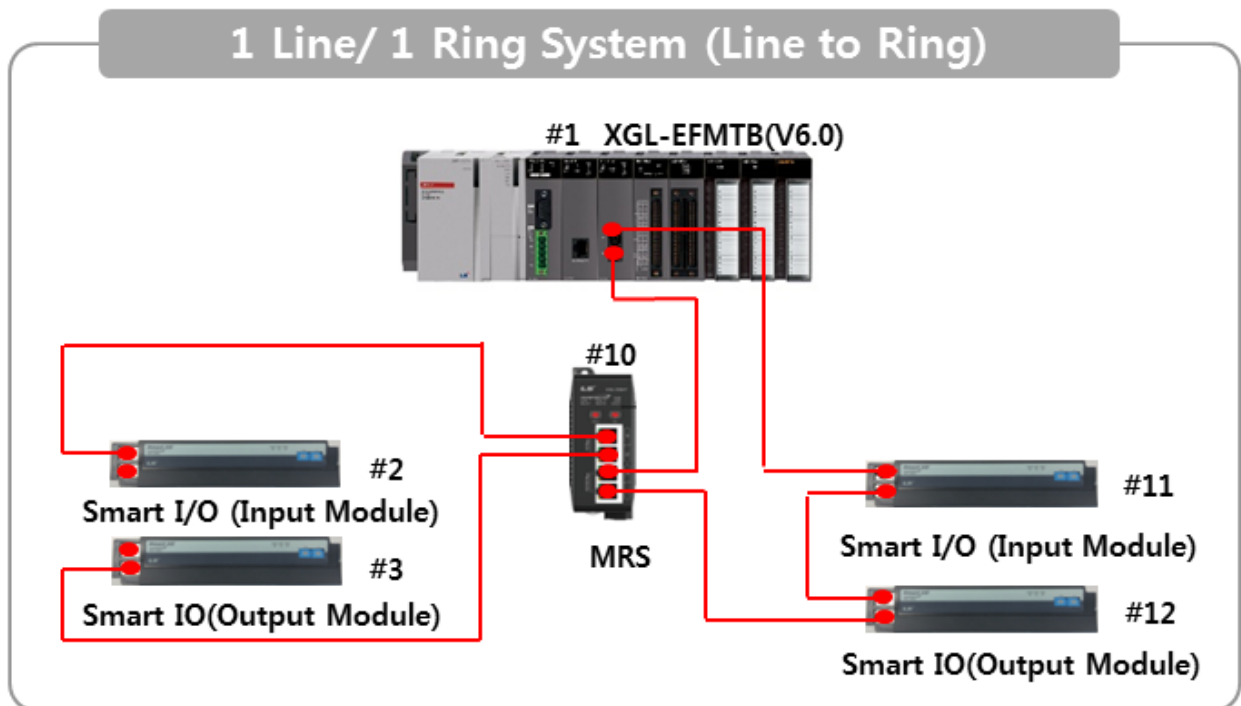

(2) It is possible to configure various system types by using single type MRS.  
 (Commercial Ethernet compatibility)

1) RAPIEnet (1, 2 Port), Ethernet (3, 4 Port)

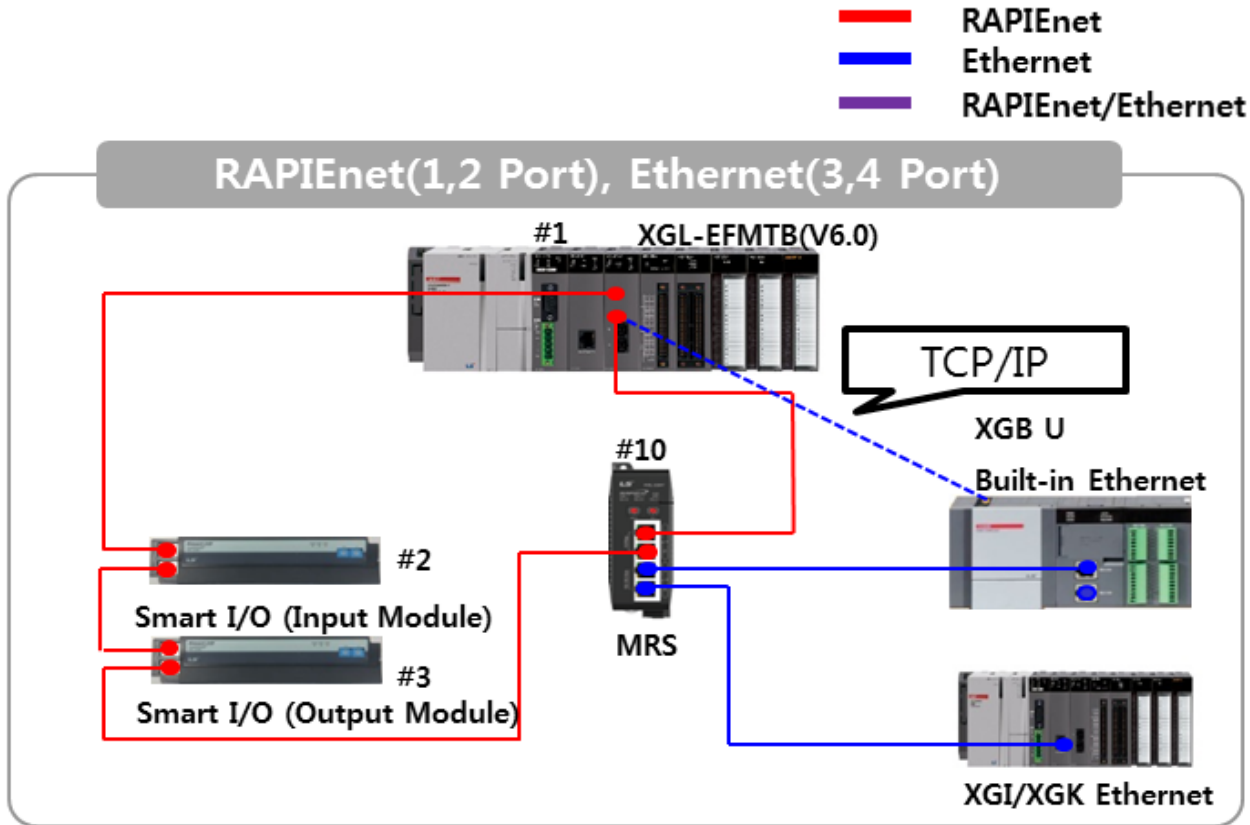

2) Ethernet (1, 2 Port), RAPIEnet (3, 4 Port)

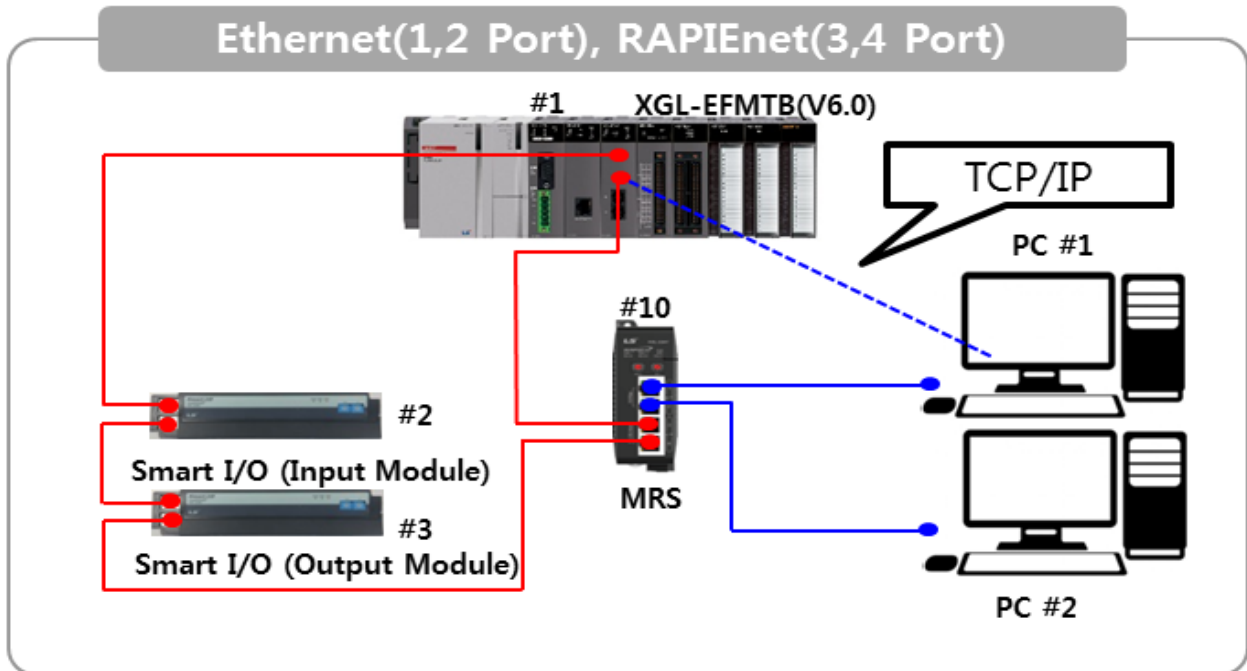

3) Ethernet ,RAPIEnet(1, 2 Port), Ethernet (3, 4 Port)

- RAPIEnet
- Ethernet
- RAPIEnet/Ethernet

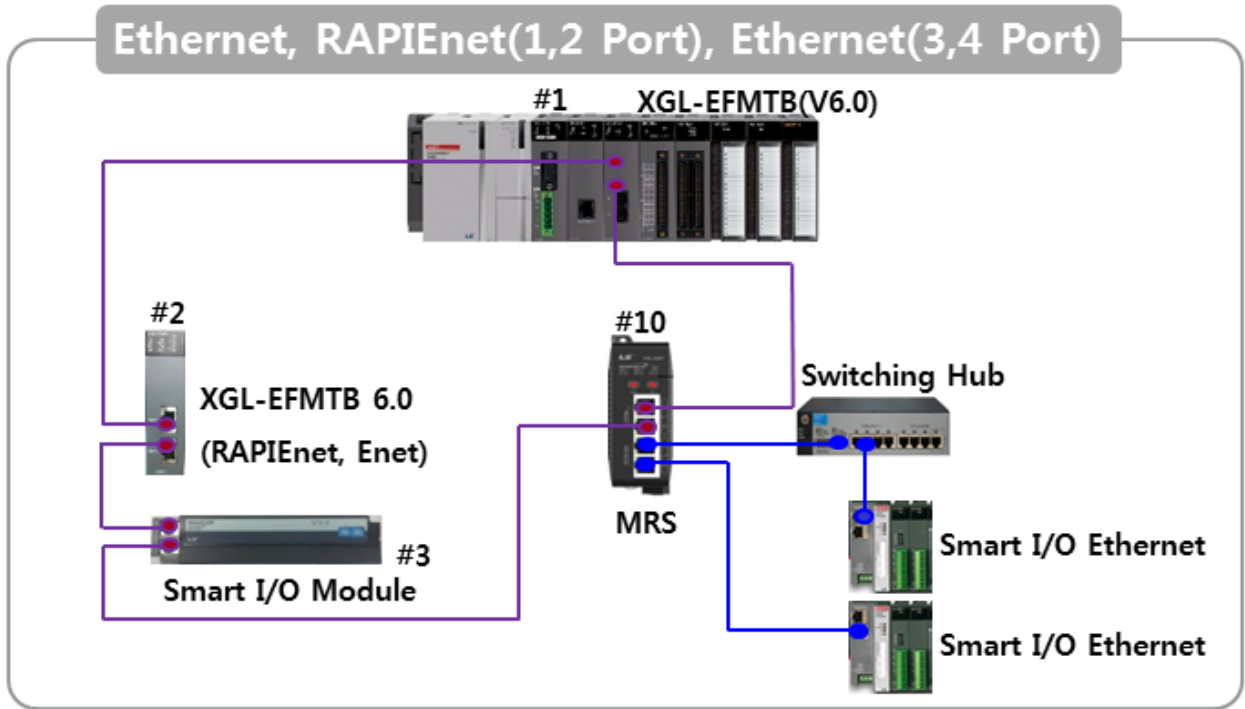

4) RAPIEnet, Ethernet (1, 2 Port), RAPIEnet, Ethernet (3, 4 Port)

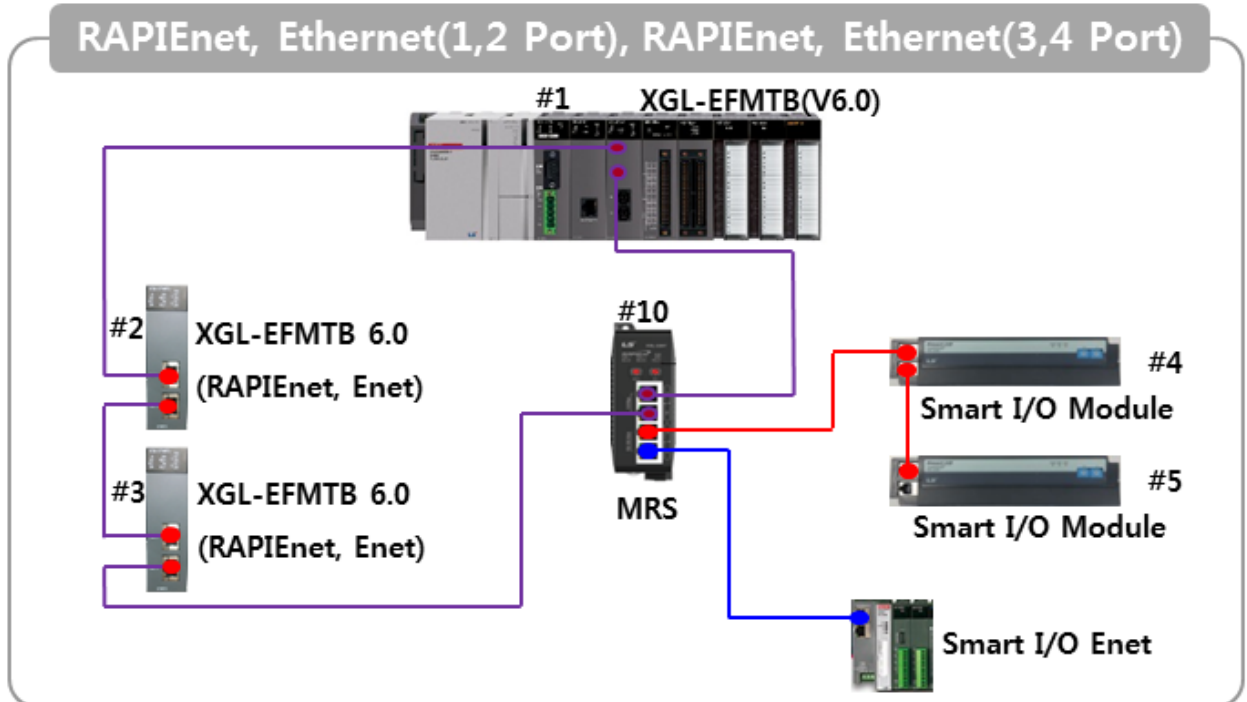

# Chapter 5 XG5000 Program

In order to operate FEnet I/F module, XG5000, a dedicated S/W for communication modules, must be used to setup or manage parameters of communication modules including FEnet I/F module.

XG5000 is dedicated software to setup parameters and of communication modules such as FEnet, Cnet, DeviceNet and Profibus-DP communication modules, manage and diagnose communication modules.

## 5.1 Introduction

As a basic program tool needed to setup, control and manage the network in Ethernet communication, XG5000 is used to setup and manage all of the communication parameters including system parameters, service parameters, module and network diagnosis, etc.

With regard to Ethernet network, the functions of XG5000 can be mainly classified as follows;

- 1) Basic parameters setting of communication system,
- 2) Parameters setting of communication service (HS link, P2P, dedicated service)
- 3) Diagnosis service for module and network

Parameters and files the user has specified can be written (downloaded) on and read (uploaded) from Ethernet communication module through CPU module. Since once downloaded communication system parameters are managed by CPU, they can be directly used without resetting even if a new communication module is installed on the initially specified position.

This chapter will focus on the description of settings necessary for the application of Ethernet module

## 5.2 Basic Settings

### 5.2.1 PLC type setting

To connect XG5000 to PLC, it is necessary to set PLC type. To create new project, click [File] → [New File] in XG5000 Menu. At new project menu, set the project name, project type and PLC type. [Fig 5.2.1] is initial screen of XG5000

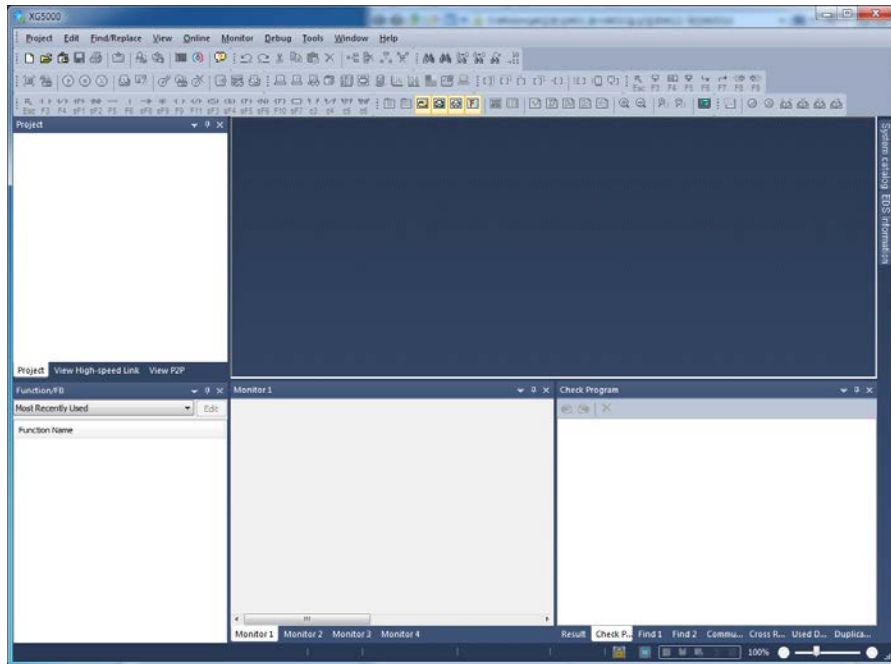

[Fig 5.2.1] Start Page of XG5000

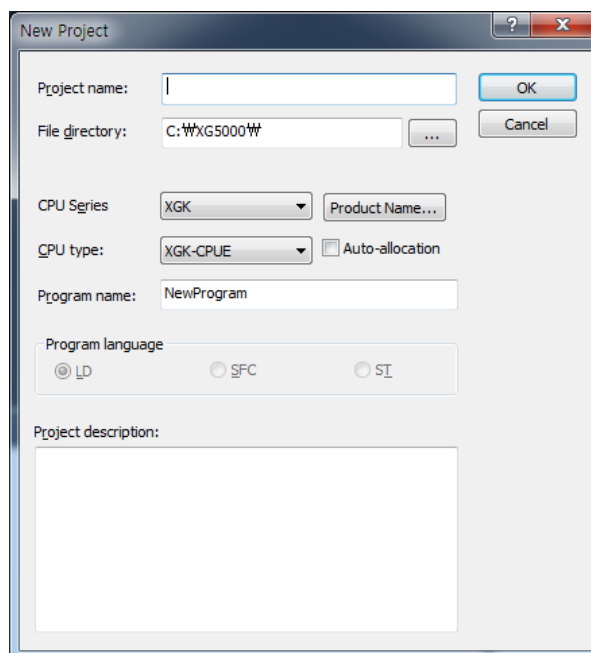

[Fig. 5.2.2] Create new project

There are 4 types of PLC series; XGK, XGB, XGI and XGR. For more detail, refer to relevant user manual. Here XGK is selected as example. There are 5 CPUs in XGK; XGK-CPUU, XGK-CPUA, XGK-CPUE and XGK-CPUS.

After setting is complete, menu of [Fig 5.2.3] will be displayed.

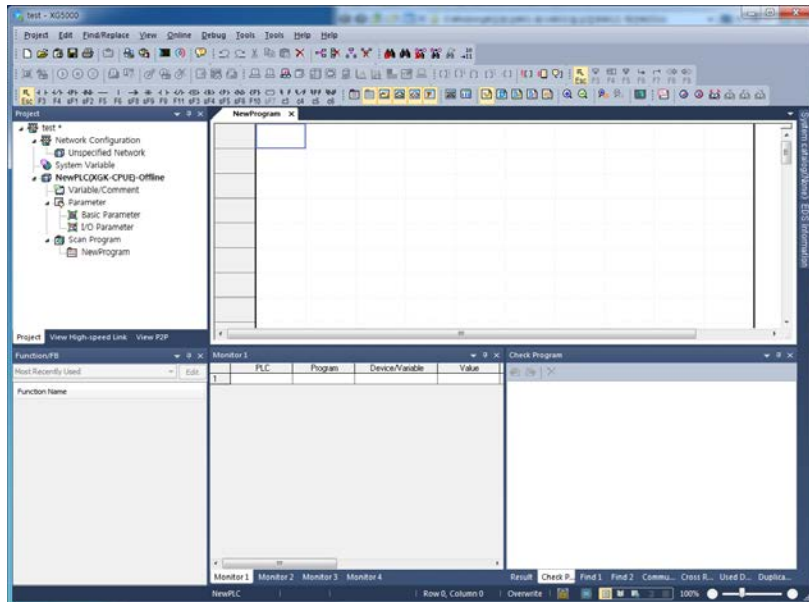

[Fig 5.2.3] Initial menu of XG5000

### 5.2.2 Register of communication module

Here describes standard setting that is necessary to execute FENet module

#### (1) Selection and execution of communication module

For standard setting of communication module, register the communication module at relevant base, slot. The user can register in on-line or off-line status.

##### A) Register in off-line status

If you register a communication module without connected to XGT, Use a “Communication module setting” window.

If FENet is to be registered on base 0 and slot 2, Set it in the following procedure at a project Window.

a) Right click [unspecified Network] -> [add item] -> [Communication module]

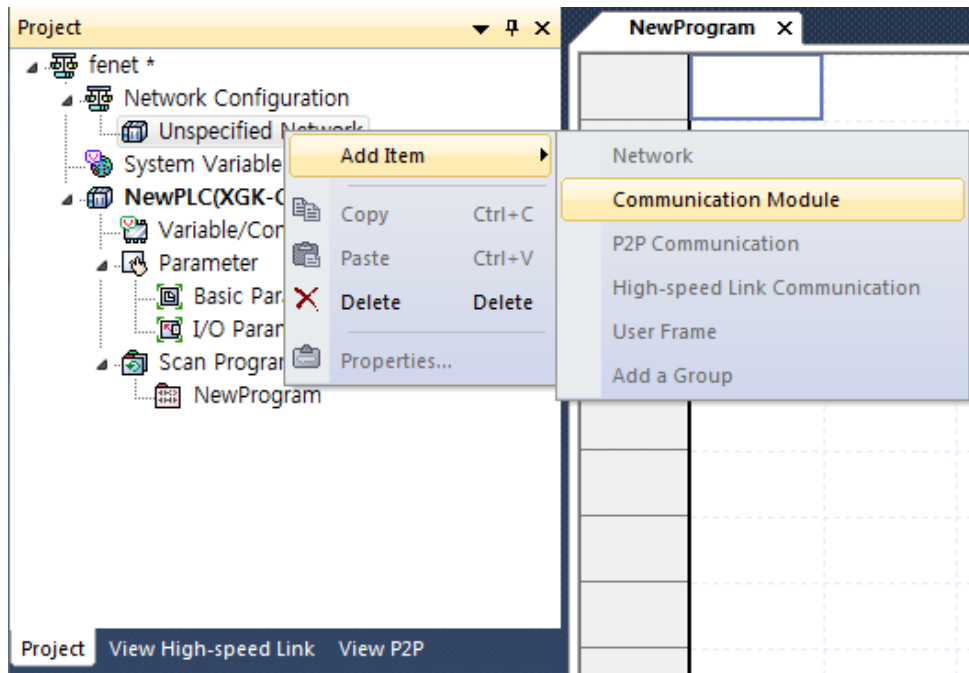

[Fig 5.2.4] Select communication module menu

b) Click [Select communication module] -> [Add module]

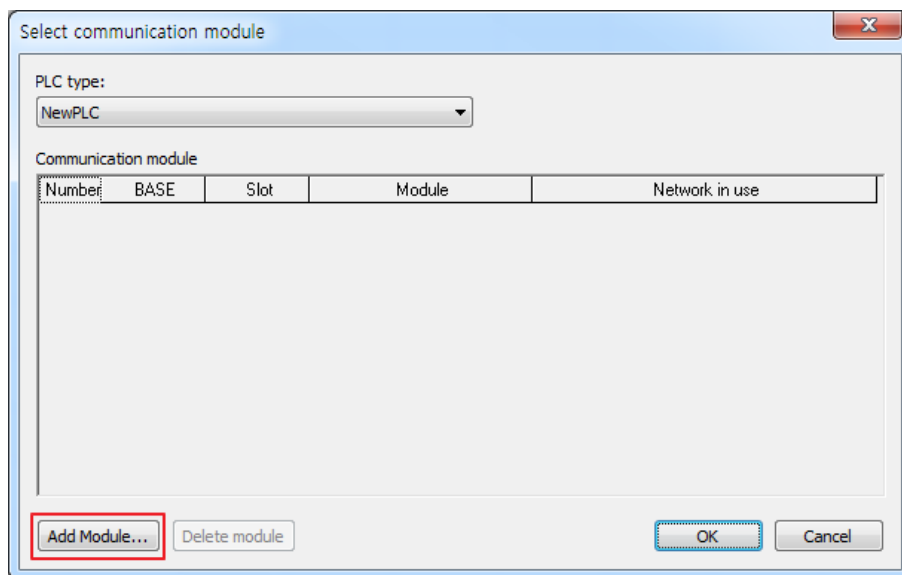

[Fig 5.2.5] Add module

c) [Communication module settings] -> select module type, base, slot

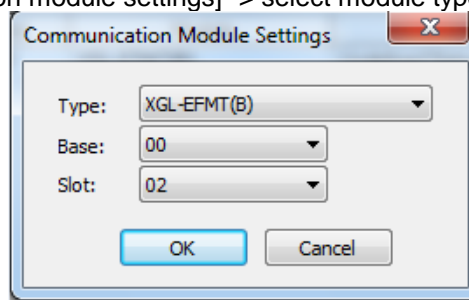

[Fig. 5.2.6] Communication module setting

FEnet module is registered on Slot 2 of Base 0 is as shown below;

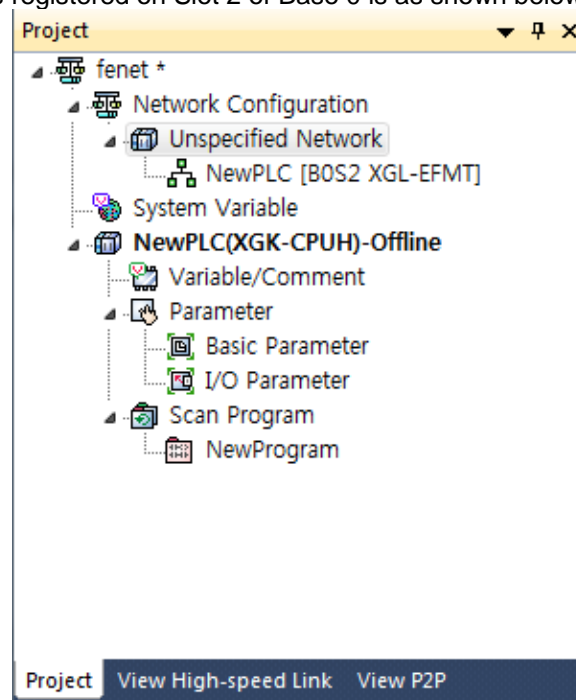

[Fig. 5.2.7] Manually register communication module

B) Register in Online status.

If Connect XG5000 and PLC on which the communication module is installed, I/O sync can help automatically register module.

a) Select [Online] -> [Diagnosis] -> [I/O information]

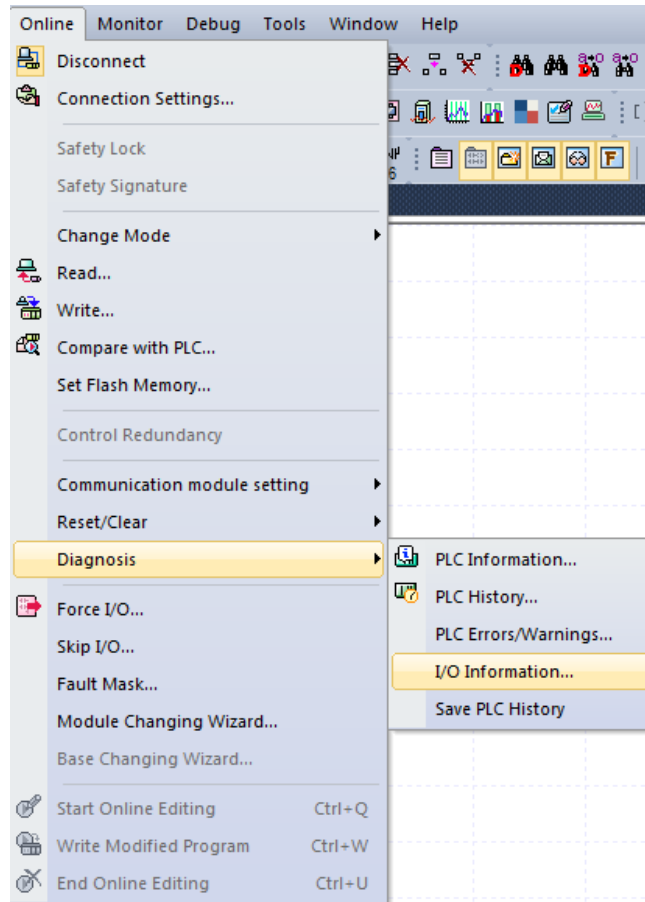

[Fig. 5.2.8] I/O information

b) Click [I/O information] -> [I/O sync]

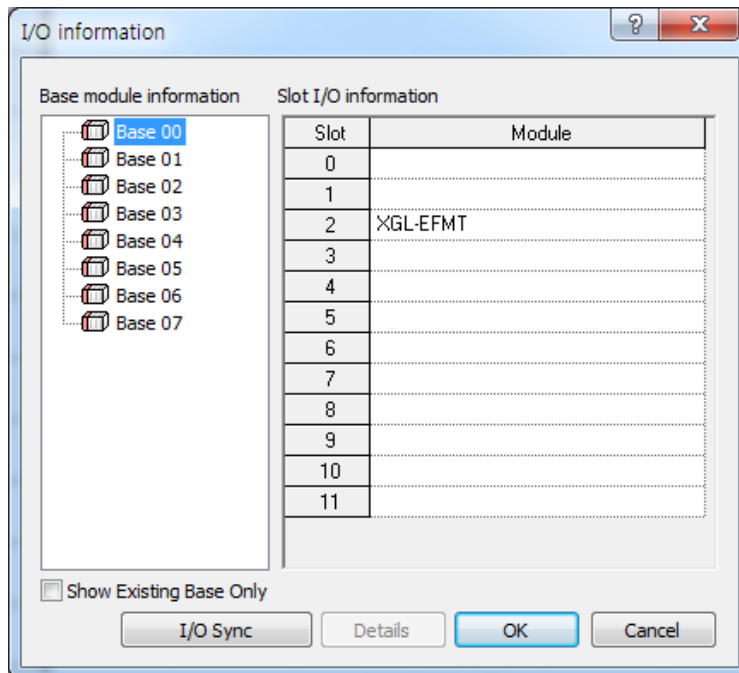

[Fig. 5.2.9] I/O Sync

c) Check message and click OK button.

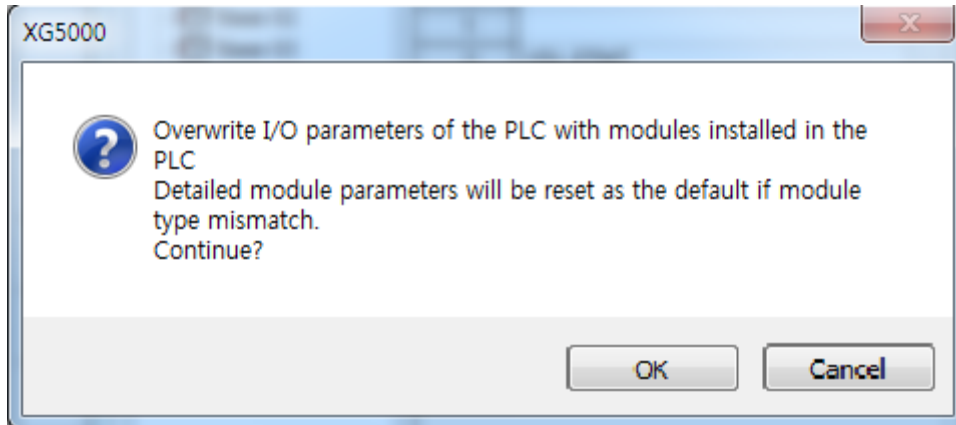

[fig. 5.2.10] I/O sync warning message

FEnet module is registered on Slot 2 of Base 0 is as shown below;

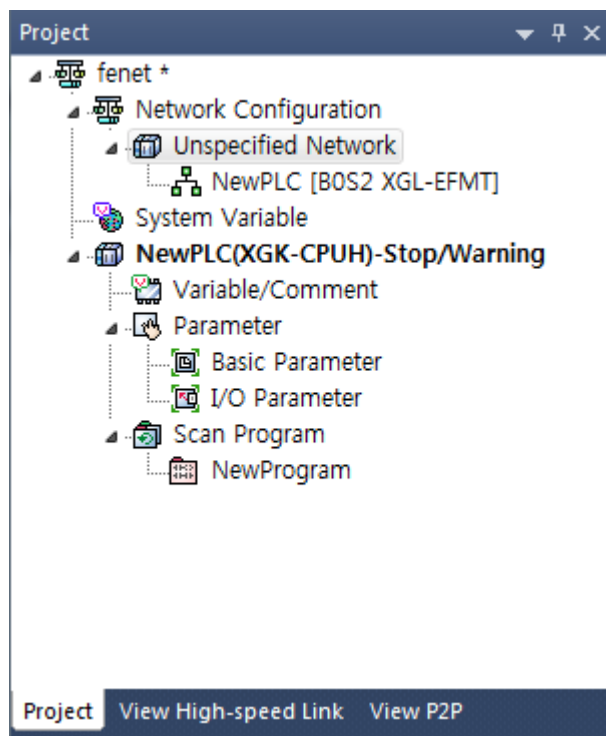

[Fig. 5.2.11] Automatically register communication module.

### 5.2.3 Standard settings (Module)

Standard settings is to specify communication system parameters necessary to control and manage the Ethernet network, which will decide basic items such as FEnet I/F module's IP address, subnet mask, gateway address, DNS server, reception latency time, number of dedicated connections, host table setting, etc.

Thus, surely set basic parameters on the standard settings screen of the module window so to download for the Ethernet communication. Standard settings are classified into for XGI/XGK and for XGR.

(1) In case CPU is XGK/XGI series

[Fig. 5.2.12] shows specified standard parameters in case CPU is XGI/XGK

[Fig. 5.2.12] Standard settings (details) in case of XGK/XGI

Details on the screen displayed in [Fig. 5.2.12] are as follows;  
Among those details below, IP address, High-speed link station No. and media shall be reset appropriately for the application environment.

### 1) TCP/IP setting

Classification	Description
Station No.	Specify station No. for High-speed link communication between LSIS PLCs' FEnet I/F modules, which shall not be duplicated identically to the correspondent communication module.  * Notes for OS version V6.0 or above. When using RAPIEnet/Modbus RTU.ASCII/XGT Cnet dedicated communication, It can be used for Station number.
Media	Select media to use. ▷ AUTO (electric) : automatically detects the module presently installed. ▷ 10M/HALF : 10MBps Half Duplex electric ▷ 10M/FULL : 10MBps Full Duplex electric ▷ 100M/HALF : 100MBps Half Duplex electric ▷ 100M/FULL : 100MBps Full Duplex electric ▷ FX/100M/HALF : 100MBps Half Duplex optical ▷ FX/100M/FULL : 100MBps Full Duplex optical
IP address	Specify the IP Address of the applicable FEnet I/F module.
Subnet mask	Value necessary to check if destination station is on the same network of the applicable station.
Gateway	IP address of Gateway or Router to transmit/receive data through the public network or a network different from the network where the applicable FEnet module is included.
DNS server	Specify the IP address of domain name server.
DHCP <sup>(note1)</sup>	Check DHCP option when not fixed but dynamic IP is to be used (ADSL).
Relay	Using when send frame received at one port to another port.
Reception wating time	If there is no request during the specified time from the host PC or MMI connected for dedicated communication, it will end the dedicated service connection regardless of normal ending procedures supposing that the higher level system is with error. This time is used in dedicated service to reset the channel when any error occurs on the destination station or the cable is disconnected.
Number of dedicated connections	Max. number of TCP dedicated services accessible at a time. (1~16) - OS V6.0 or under It can get 1~16 connections. And default connection setting is 3 connections. - OS V6.0 or above It can get 64 connections per each TCP port.

2) Driver (server) setting

Classification	Description
XGT server	Set when operated as dedicated communication server (slave) (TCP Port:2004, UDP Port:2005)  - OS V6.0 or under: XGT Enet dedicated communication sever. - OS V6.0 or above: XGT Enet dedicated communication sever / XGT Cnet dedicated communication sever are supported at the same time.
Modbus TCP/IP server	Set when operated as Modbus server driver (slave) (TCP Port:502)  - OS V6.0 or under: Modbus TCP sever. - OS V6.0 or above: Modbus TCP/RTU/ASCII sever are supported at the same time.
Smart server	XGT server/Modbus servers are supported at the same time. (OS V6.0 or above)

3) RAPIEnet setting

Classification	Description
RAPIEnet setting (OS V6.0 or above)	Select protocol driver when using RAPIEnet. - Disable: RAPIEnet is disabled. - LSIS RAPIEnet

4) Host table setting

Classification	Description
Enable host table	Access allowed to applicable module of IP address registered in host table (unregistered client(IP address) is prohibited from connection when enabled)

### Notes

(Note 1) Notice in setting DHCP

(1) To check the IP address after DHCP setting, check IP address in Online -> System diagnosis -> Detailed module information or click standard setting after executing Open From PLC.

(2) In case of dynamic IP address, IP address is reset when module is disconnected from server or Power is off

(3) In case of using Remote connection to module using DHCP, when remote side restart, you have to check the IP address of remote station

(4) In case of using DHCP with XGL-EFMTB/EFMFB, you have to use only port 1.

(1) In case CPU is XGR series

[Fig. 5.2.13] shows specified standard parameters in case CPU is XGR CPU. In case of XGR, some of items in Standard setting is different according to whether you use ONE IP Solution or not.

Standard Settings

Standard Settings Host Table Settings

ONE IP Solution (Station Number and IP on standby are Master+1)

TCP/IP Settings

One IP

Station No.: 0

Media: Port1: AUTO(electric) Port2: AUTO(electric)

IP address: 192 . 168 . 80 . 2

Subnet Mask: 255 . 255 . 255 . 0

Gateway: 192 . 168 . 80 . 1

DNS Server: 0 . 0 . 0 . 1

DHCP

Relay

No. of Dedicated Connections: 3 (1 - 16)

Receive Time Out Settings

Client: 60 sec(2 - 255)

Server: 15 sec(2 - 255)

Driver Setting

Server Mode: XGT server Modbus Settings

RAPIEnet Settings: Disable

OK Cancel

[Fig. 5.2.13] Standard settings (details) in case of XGR

Details on the screen displayed in [Fig. 5.2.13] are as follows;  
Among those details below, IP address, High-speed link station No. and media shall be reset appropriately for the application environment.

## 1) TCP/IP setting (XGI/XGK series)

Classification	Description
ONE IP Solution	<p>1. You are able to connect to master base FENet of XGR redundancy system with one IP regardless of Master conversion. For this, in case of master conversion, FENet modules of master base and standby base exchange each other's IP address</p> <p>2. If you check ONE IP Solution, ONE IP Solution function is activated and you register only one IP</p> <p>3. When using ONE IP Solution, IP address should be even number. That number become FENet module IP address of master base</p> <p>4. The above number + 1 becomes FENet module IP address of standby base</p>
Station No.	<p>Specify station No. for High-speed link communication between LSIS PLCs' FENet I/F modules, which shall not be duplicated identically to the correspondent communication module.</p> <p>* Notes for OS version V6.0 or above. When using RAPIEnet/Modbus RTU.ASCII/XGT Cnet dedicated communication, It can be used for Station number.</p>
Media	<p>Select media to use.</p> <ul style="list-style-type: none"> <li>▷ AUTO (electric) : automatically detects the module presently installed.</li> <li>▷ 10M/HALF : 10MBps Half Duplex electric</li> <li>▷ 10M/FULL : 10MBps Full Duplex electric</li> <li>▷ 100M/HALF : 100MBps Half Duplex electric</li> <li>▷ 100M/FULL : 100MBps Full Duplex electric</li> <li>▷ FX/100M/HALF : 100MBps Half Duplex optical</li> <li>▷ FX/100M/FULL : 100MBps Full Duplex optical</li> </ul>
IP address	Specify the IP Address of the applicable FENet I/F module.
Subnet mask	Value necessary to check if destination station is on the same network of the applicable station.
Gateway	IP address of Gateway or Router to transmit/receive data through the public network or a network different from the network where the applicable FENet module is included.
DNS server	Specify the IP address of domain name server.
DHCP	Check DHCP option when not fixed but dynamic IP is to be used (ADSL).
Relay	Using when send frame received at one port to another port.
Reception wating time	If there is no request during the specified time from the host PC or MMI connected for dedicated communication, it will end the dedicated service connection regardless of normal ending procedures supposing that the higher level system is with error. This time is used in dedicated service to reset the channel when any error occurs on the destination station or the cable is disconnected.
Number of dedicated connections	<p>Max. number of TCP dedicated services accessible at a time. (1~16)</p> <ul style="list-style-type: none"> <li>- OS V6.0 or under It can get 1~16 connections. And default connection setting is 3 connections.</li> <li>- OS V6.0 or above It can get 64 connections per each TCP port.</li> </ul>

## Chapter 5 XG5000 Program

Classification	Description
A->B, B->A	This option is activated When One IP Solution is not is not used. After setting parameter of A side or B side, if you click A->B, B->A, the parameters in one side is copied into another side.

### 2) Driver (server) setting

Classification	Description
XGT server	Set when operated as dedicated communication server (slave) (TCP Port:2004, UDP Port:2005)  - OS V6.0 or under: XGT Enet dedicated communication sever. - OS V6.0 or above: XGT Enet dedicated communication sever. / XGT Cnet dedicated communication sever. support at the same time.
Modbus TCP/IP server	Set when operated as Modbus server driver (slave) (TCP Port:502)  - OS V6.0 or under: Modbus TCP sever. - OS V6.0 or above: Modbus TCP/RTU/ASCII severes are supported at the same time.
Smart Server	Supports XGT Server and Modbus Server at the same time.

### 3) RAPIEnet setting

Classification	Description
RAPIEnet setting (OS V6.0 or above)	Select protocol driver when using RAPIEnet. - Disable: RAPIEnet is disabled. - LSIS RAPIEnet

### 4) Host table setting

Classification	Description
Enable host table	Access allowed to applicable module of IP address registered in host table (unregistered client(IP address) is prohibited from connection when enabled)

### Notes

(Note 1) Notice in setting DHCP

- (1) To check the IP address after DHCP setting, check IP address in Online -> System diagnosis  
-> Detailed module information or click standard setting after executing Open From PLC.
- (2) In case of flexible IP address, IP address is reset when module is disconnected from server or Power is off
- (3) In case of using Remote connection to module using DHCP, when remote side restart, you have to check the IP address of remote station
- (4) In case of using DHCP with XGL-EFMTB/EFMFB, you have to use only port 1.

## 5.3 High-speed Link Settings

### 5.3.1 Setting of High-speed link parameters

How to set High-speed link communication of FENet I/F module will be described. High speed links of FENet I/F module are supported up to 12 according to the number of installed module. For each HS link, 32 transmission blocks, 128 reception blocks are available. And in case of combined setting of transmission/reception block, 128 blocks are available.

- (1) Choose one method in two methods from Initial selection screen
- 1) Click project tab, Right click [Unspecified network]

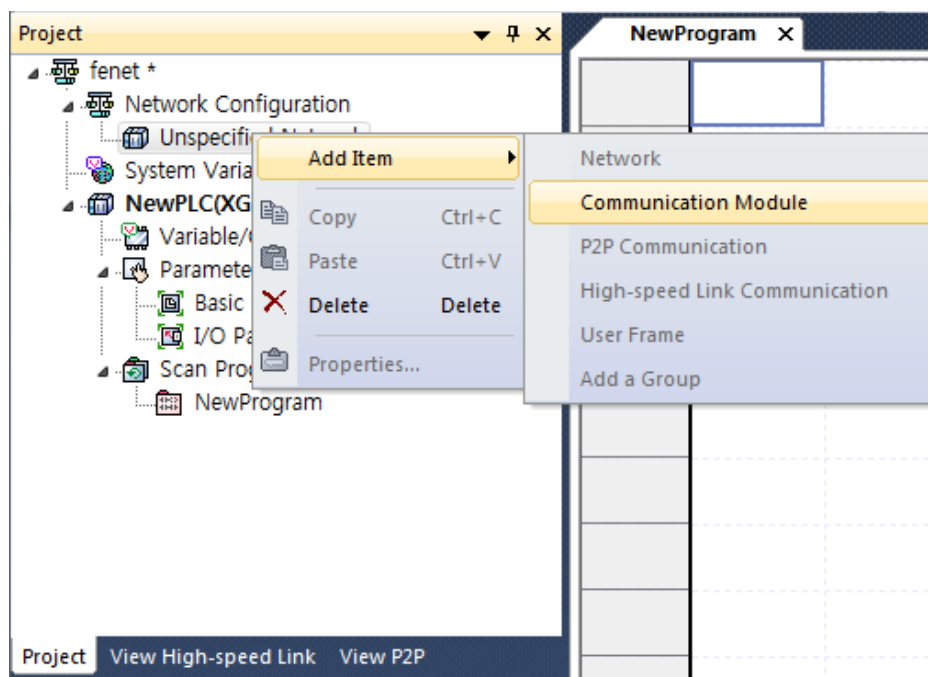

[fig.5.3.1] Select High speed Communication from Project tab

- 2) Click view High-speed Link tab, Right click 'PLC name'

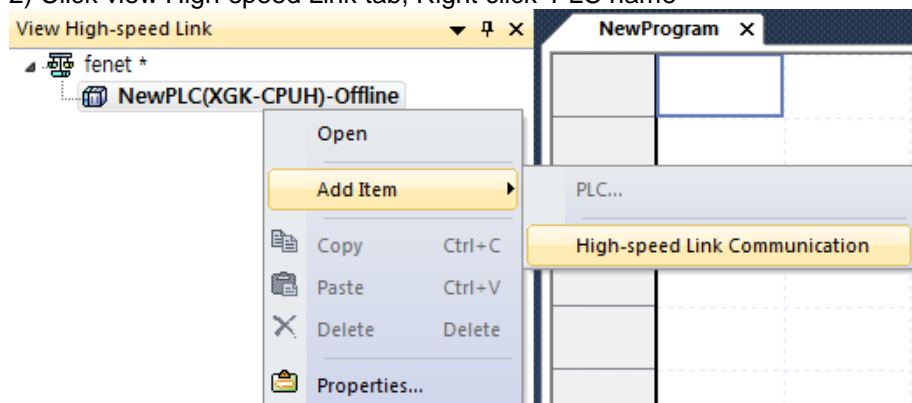

[fig.5.3.2] Select High speed Communication

(2) Setting communication module

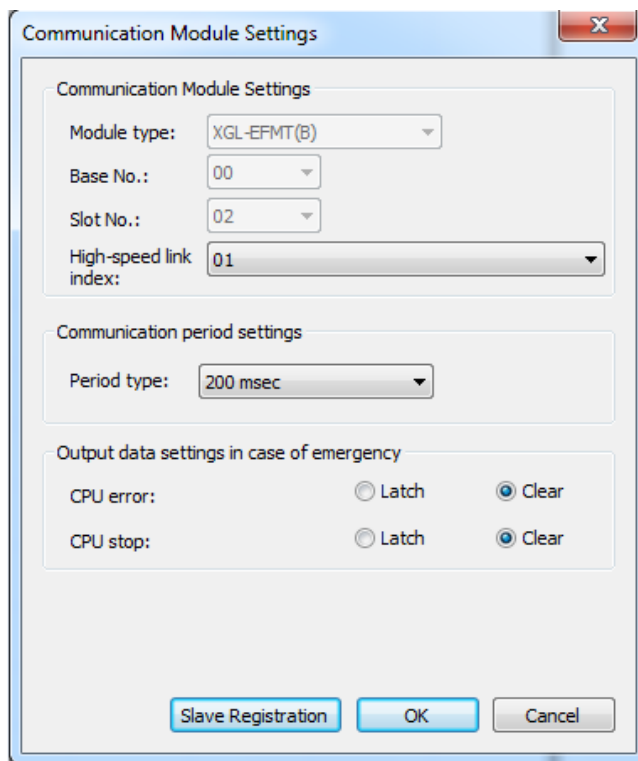

[fig.5.3.3] Setting of communication module and communication period

Classification		Description
Communication module settings	Module type	Select FENet.
	Base No.	Select Base No. the module is installed on. (Main Base : 00)
	Slot No.	Select Slot No. the module is installed on.
Communication period settings	Period type	Set the data transmission period. (available range is 5ms~10sec)
Output data setup in case of emergency	Latch	Maintain and send the latest data received from CPU. It is seen that it is cleared if CPU sends data as 0 even though latch is set. Make sure to check the emergency output data setting of CPU.
	Clear	It sends by setting received High-speed Link data as 0 in ignoring data from CPU. If emergency data is set as 'clear' in emergency output data setting of XG5000 High-speed Link module setting even though emergency output data setting of device area of High-speed Link sending part is set as latch in CPU, the data set as 0 is sent. Make sure to set it after checking desired operation.
Slave register (OS V6.0 or above)		Select RAPIenet Smart I/O that wants to register in high speed link.

(3) After select communication module

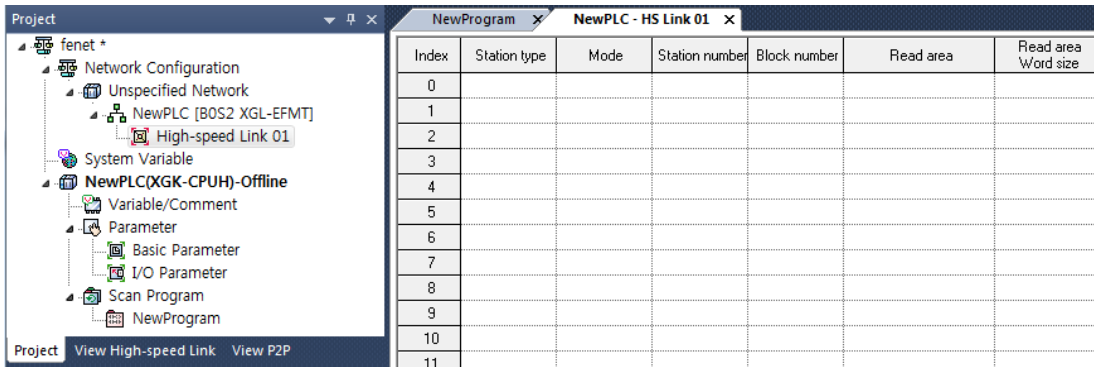

[fig.5.3.4] double click High-speed Link 01 from project tab

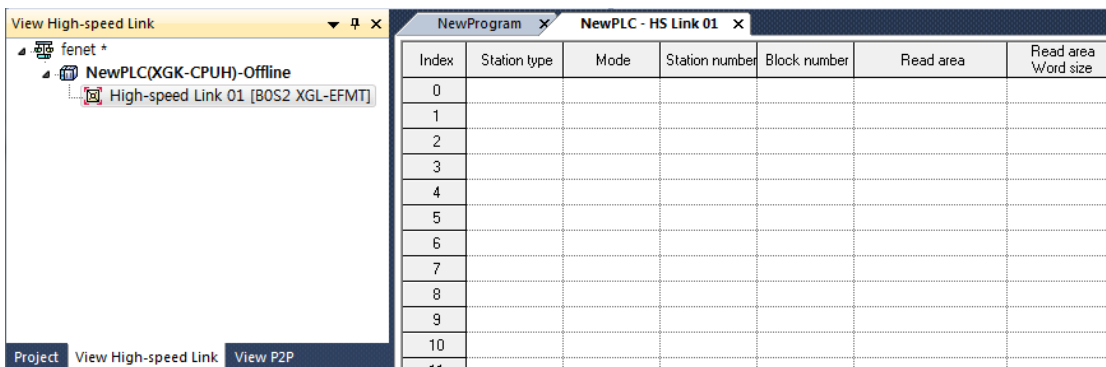

[fig.5.3.5] double click High-speed Link 01 from View High-speed Link tab

(4) High-speed link parameters settings (double-click High-speed link parameters window)

Index	Station type	Mode	Station number	Block number	Read area	Read area Word size	Save area	Save area Word size
0								
1								
2								
3								
4								

[Fig. 5.3.6] High-speed link block settings

Classification		Description
Station type	FEnet	This item is not related with FEnet I/F module so this is always fixed as 'MASTER'
	RAPIDnet (V6.0 or above)	
	RAPIDnet Remote (V6.0 or above)	
Mode	1.Send	Sends data
	2.Receive	Receives data
	3. Send /Receive	* Supports only for V6.0 or above Send data and Receive data When RAPIDnet Smart IO is selected, it automatically set.
Station No.		In case of Send Mode, it indicates station number of this module. And in case of Receive Mode, it indicates that of target module.

## Chapter 5 XG5000 Program

---

Block No.	Specify Tx Block and Rx Block. * Note for OS V6.0 - RAPIEnet Smart IO is automatically set to have the same station number and block number.
Read area	Memory area of this module. (P,L,M,K,...)
Read area Word size	Specify data size to transmit..(WORD)
Save area	Area to save data received from the destination station.
Save area Word size	Specify data size to receive.

(5) Writing High-speed Link Parameter

- 1) Click [Online] -> [Write]

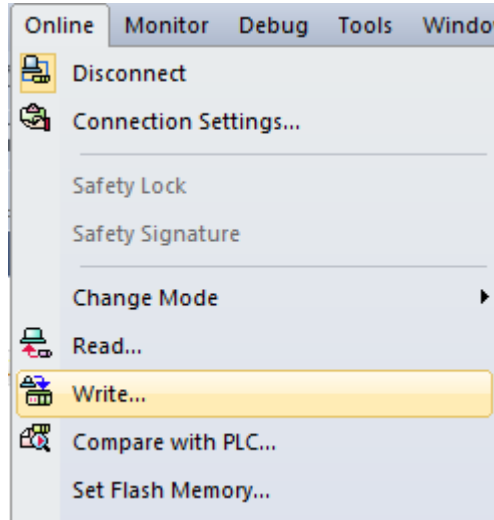

[fig.5.3.7] Write menu

- 2) Check [High speed Link] and Click 'OK' button.

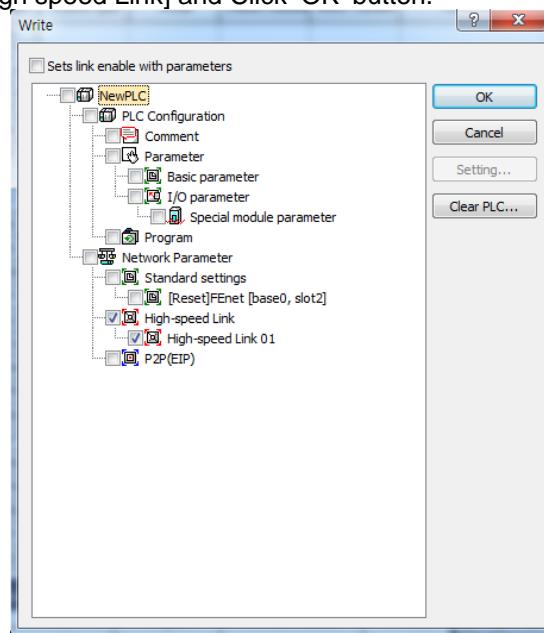

[Fig 5.3.8] Writing High-speed Link parameter

### (6) Reading High-speed Link parameter

1) Click [Online] -> [Read].

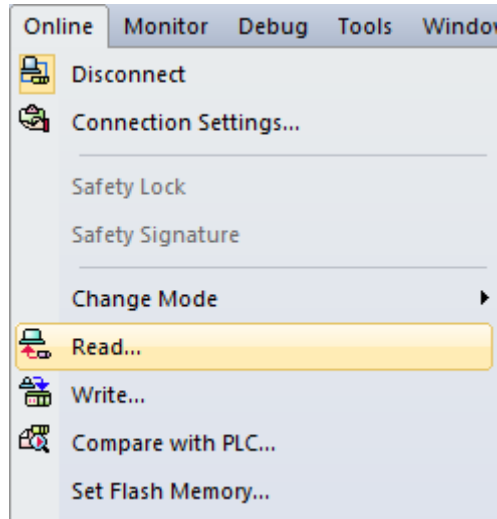

[Fig.5.3.9] Read menu

2) Check [High speed Link] and Click 'OK' button.

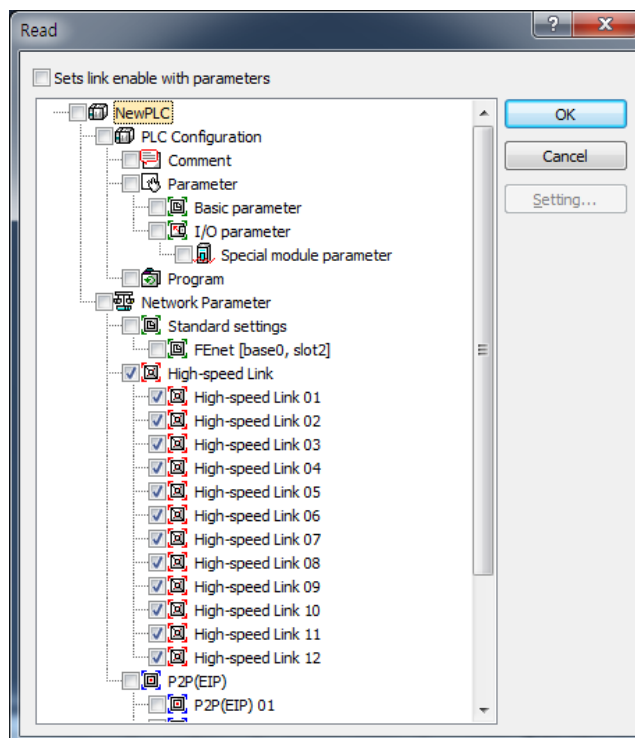

[Fig 5.3.10] Reading High-speed Link parameter

### 5.3.2 High Speed Link parameter at XGR redundant system

Standard setting is same with XGK, XGI but parameter of communication module of MASTER and STANDBY should be set respectively. At redundant system, available number of module is up to 6.

(1) Standard settings

For standard setting in redundancy, you can set one HS link station number and IP address etc. by using One IP Solution or can set parameters of A side and B side separately by not using One IP Solution. For more detail, refer to CH6 High Speed Link service.

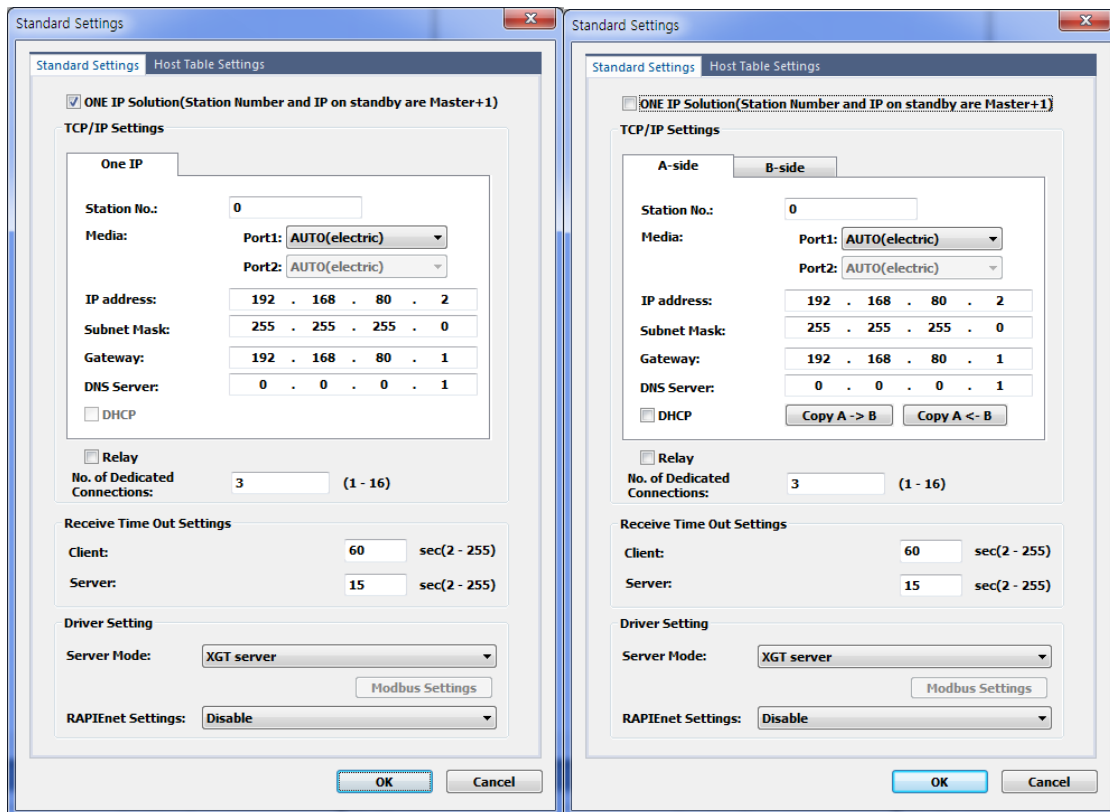

[Fig 5.3.11] Redundant standard setting screen

## 5.4 P2P Settings

### 5.4.1 P2P parameters

P2P setting of FENet I/F module will be described. P2P Setting is possible to up to 8  
Each P2P set the block up to 64.

- (1) Choose one method in two methods from Initial selection screen
  - 1) Click project tab, Right click [Unspecified network]

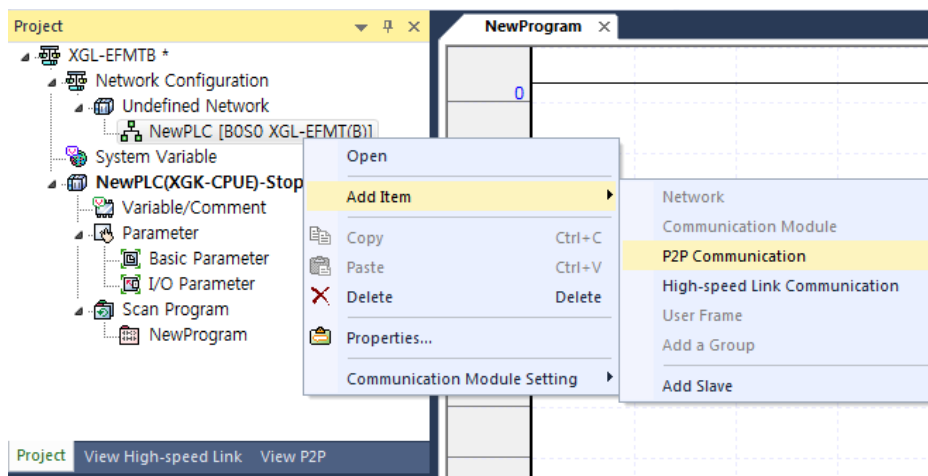

[fig.5.4.1] Select communication module from Project tab

- 2) Click view P2P tab, Right click 'PLC name'

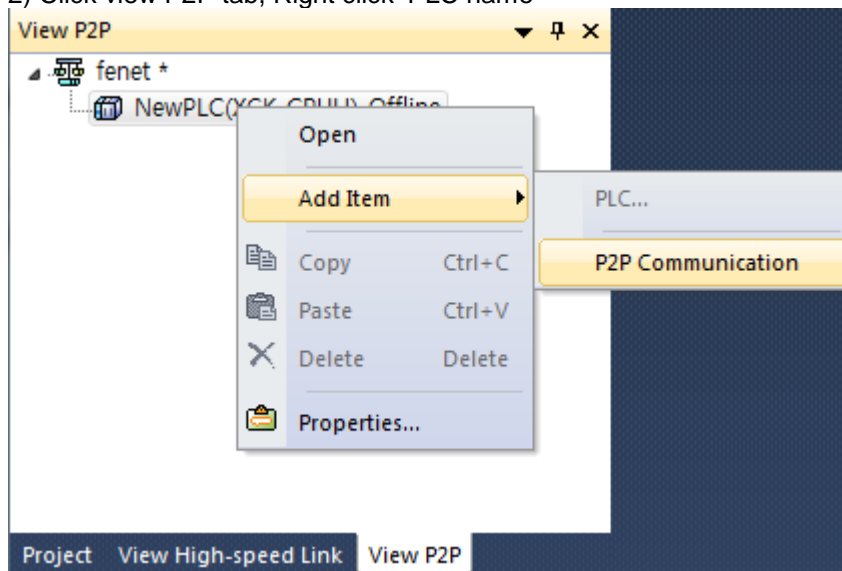

[fig.5.4.2] Select View P2P tab

(2) Setting Communication module

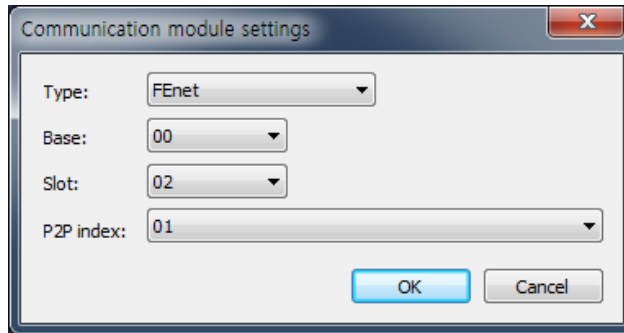

[Fig. 5.4.3] Selection of communication module

Classification		Description
Communication module settings	Module type	Select FEnet.
	Base No.	Select Base No. the module is installed on. (Main Base : 00)
	Slot No.	Select Slot No. the module is installed on.

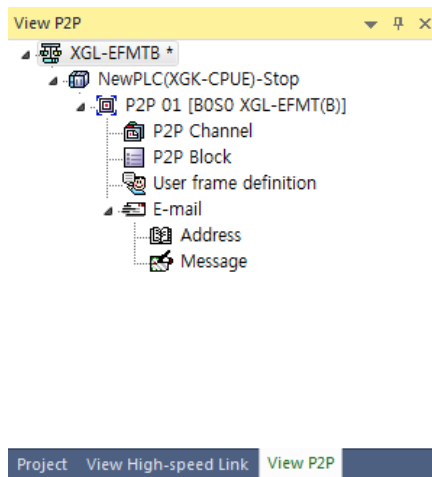

[Fig. 5.4.4] P2P setting details

After communication module setting is completed, P2P setting details screen will be displayed as in [Fig. 5.4.3]. Refer to Chapter 7 P2P Service for detailed setting.

Classification		Description
P2P channel	User defined frame	Edit the user defined protocol.
	XGT Enet client	Set XGT Enet dedicated service master.
	Modbus TCP client	Set to Modbus TCP master.
	XGT Cnet client (OS V6.0 or above)	Set XGT Cnet dedicated service client.
	Modbus RTU client (OS V6.0 or above)	Set Modbus RTU client.

	Modbus ASCII client (OS V6.0 or above)	Set Modbus ASCII client.
	RAPIEnet client (OS V6.0 or above)	Set RAPIEnet client. (However, RAPIEnet must be enabled in the basic parameter.)
	P2P Block	Set each command block based on specified XGT client of P2P channel.
	User defined frame	Set each command frame for the user defined frame of P2P channel.
	E-mail	Execute as defined by the user for E-mail service.

## 5.5 Connect and Download to Communication Module

### 5.5.1 Download/Upload

XG5000 can be used for downloading (writing) specified parameters or uploading (reading) the parameters stored in the PLC.

#### (1) Write (download)

Connect with CPU of the basic base FEnet I/F module installed on whose parameters are desired to write through [Online] -> [Connect] menu.

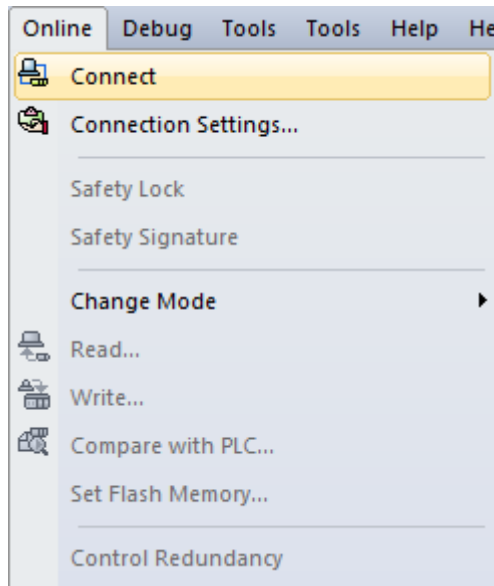

[Fig. 5.5.1] Connect menu

After connection is established, select [Online] -> [Write(standard settings, HS link, P2P)] to display [Fig. 5.5.1] screen, where to specify standard settings items of the base and slot positions FEnet I/F module to write (download) is installed on.

#### Notes

- 1) XG5000 can be programmed through RS-232C port or USB port of CPU module. Refer to CPU Module's connection diagram for detailed cable type.

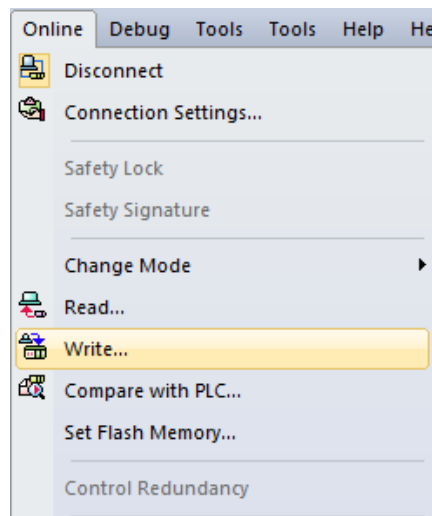

[Fig. 5.5.2] Write Parameter window

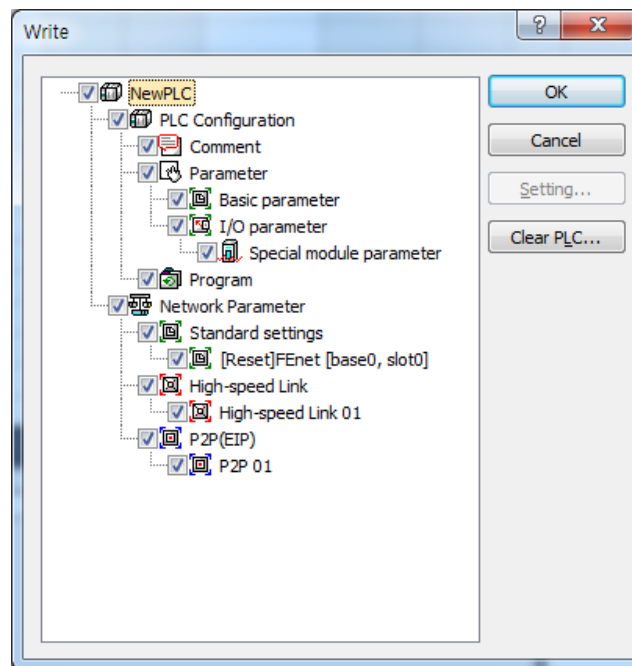

[Fig. 5.5.3] Write screen

### Notes

- 1) In case any service allows link when downloading parameter to CPU by using XG5000, it automatically works with the parameter newly downloaded after downloading the parameter; if the service does not allow the link, the parameter is not applied until the link is allowed.
- 2) In case of OS V6.0 or above, you have to reset the CPU to start normally after setting basic parameter.

(2) Read (upload)

Connect with CPU of the basic base FENet I/F module to read is installed on, and register the communication module to read standard settings.

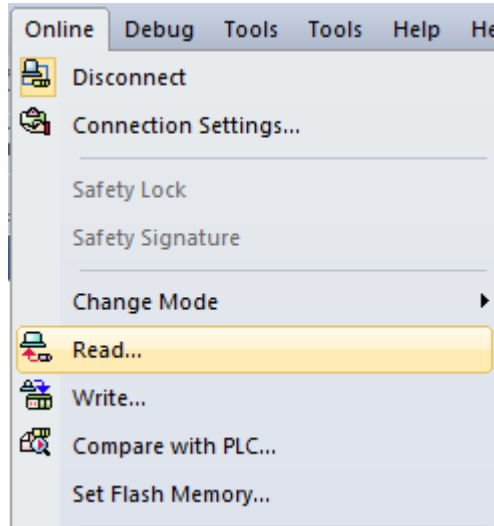

[Fig. 5.5.4] Read Parameter window

After connected, select [Online] -> [Read(standard settings, HS link, P2P)] to display [Fig. 5.5.5] screen

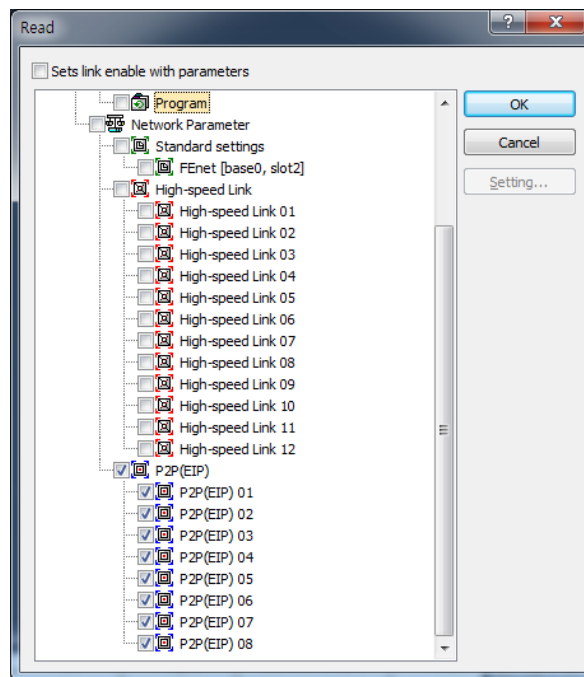

[Fig. 5.5.5] Read Parameter menu

Where, confirm Base No. and Slot No. among the standard settings items, and then select standard settings of the applicable communication module.

After Read is completed, confirm edit/standard settings of the XG5000 screen to find the data read from FENet module saved.

### 5.5.2 Enable Link

Link enable procedures are necessary to start the operation of the communication for actual Tx/Rx of downloaded High-speed link and P2P data through XG5000. Let Link Enable ON to start Tx/Rx service of the communication module, which will enable or disable the operation relationship separately from the specified parameters, where the communication will be kept on based on the Enable conditions even if CPU stops.

#### (1) Link Enable from XG5000

The next is to specify XG5000 for the Enable conditions. Click the setting menu on [Fig. 5.5.6] to display [Fig. 5.5.7]. Check the items which need the link service.

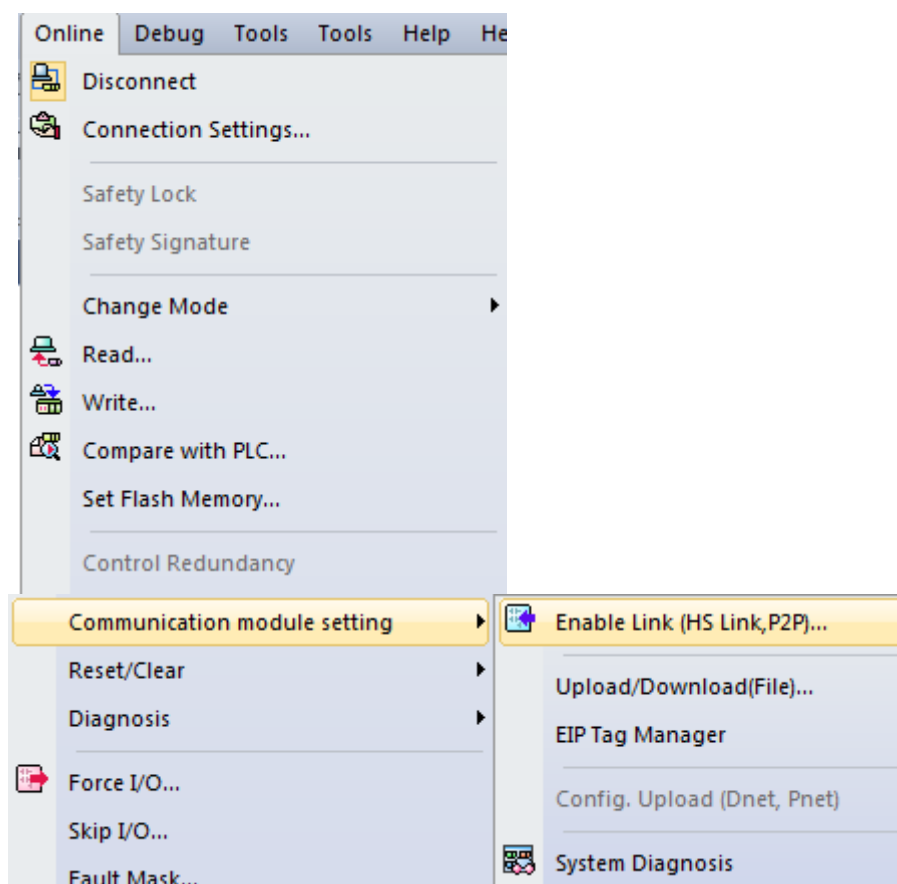

[Fig. 5.5.6] Enable Link setting

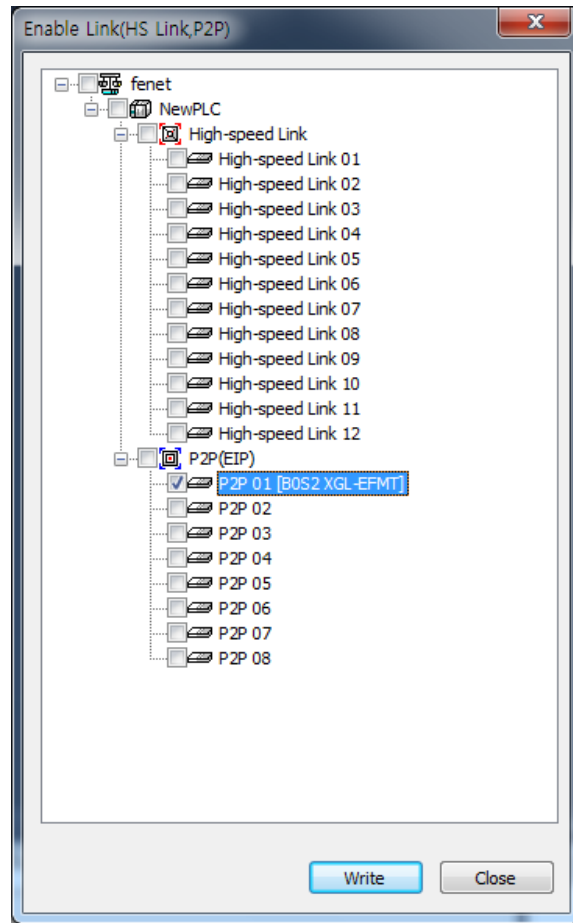

[Fig. 5.5.7] Selection of Enable Link

If Enable Link Write is executed, a message will be displayed as in [Fig. 5.5.8], which means that Link is normally enabled.

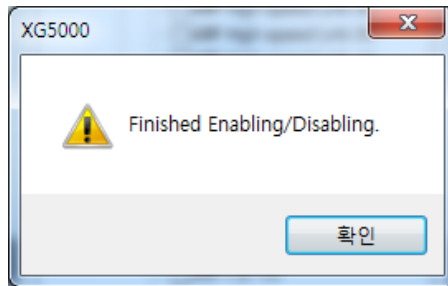

[Fig. 5.5.8] Message Screen of Enable Link

## Chapter 5 XG5000 Program

\* Enable Link through flag

It describes "Enable Link" method through flag. The following XG5000 version, CPU OS version is needed.

Item	Version
XG5000	V3.61 or above
XGR CPU	V1.91 or above
XGI CPU	V3.4 or above
XGK CPU	V3.7 or above

Flag list related with "Enable Link"

-XGR

Flag	Data type	Device	Description
_HS_ENABLE_STATE	ARRAY[0..11] OF BOOL	%FX19040	HS link enable/disable current state
_HS_REQ	ARRAY[0..11] OF BOOL	%FX31520	HS link enable/disable request
_HS_REQ_NUM	ARRAY[0..11] OF BOOL	%FX31536	HS link enable/disable setting
_P2P_ENABLE_STATE	ARRAY[0..7] OF BOOL	%FX19072	P2P enable/disable current state
_P2P_REQ	ARRAY[0..7] OF BOOL	%FX31552	P2P enable/disable request
_P2P_REQ_NUM	ARRAY[0..7] OF BOOL	%FX31568	P2P enable/disable setting

-XGI

Flag	Data type	Device	Description
_HS_ENABLE_STATE	ARRAY[0..11] OF BOOL	%FX15840	HS link enable/disable current state
_HS_REQ	ARRAY[0..11] OF BOOL	%FX16480	HS link enable/disable request
_HS_REQ_NUM	ARRAY[0..11] OF BOOL	%FX16496	HS link enable/disable setting
_P2P_ENABLE_STATE	ARRAY[0..7] OF BOOL	%FX15872	P2P enable/disable current state
_P2P_REQ	ARRAY[0..7] OF BOOL	%FX16512	P2P enable/disable request
_P2P_REQ_NUM	ARRAY[0..7] OF BOOL	%FX16528	P2P enable/disable setting

-XGK

Flag	Data type	Device	Description
_HS1_ENABLE_STATE	BIT	F09600	HS link 1 enable/disable current state
_HS2_ENABLE_STATE	BIT	F09601	HS link 2 enable/disable current state
_HS3_ENABLE_STATE	BIT	F09602	HS link 3 enable/disable current state
_HS4_ENABLE_STATE	BIT	F09603	HS link 4 enable/disable current state
_HS5_ENABLE_STATE	BIT	F09604	HS link 5 enable/disable current state
_HS6_ENABLE_STATE	BIT	F09605	HS link 6 enable/disable current state
_HS7_ENABLE_STATE	BIT	F09606	HS link 7 enable/disable current state
_HS8_ENABLE_STATE	BIT	F09607	HS link 8 enable/disable current state
_HS9_ENABLE_STATE	BIT	F09608	HS link 9 enable/disable current state
_HS10_ENABLE_STATE	BIT	F09609	HS link 10 enable/disable current state
_HS11_ENABLE_STATE	BIT	F0960A	HS link 11 enable/disable current state
_HS12_ENABLE_STATE	BIT	F0960B	HS link 12 enable/disable current state
_HS1_REQ	BIT	F10300	HS link 1 enable/disable request
_HS2_REQ	BIT	F10301	HS link 2 enable/disable request
_HS3_REQ	BIT	F10302	HS link 3 enable/disable request
_HS4_REQ	BIT	F10303	HS link 4 enable/disable request
_HS5_REQ	BIT	F10304	HS link 5 enable/disable request
_HS6_REQ	BIT	F10305	HS link 6 enable/disable request
_HS7_REQ	BIT	F10306	HS link 7 enable/disable request
_HS8_REQ	BIT	F10307	HS link 8 enable/disable request
_HS9_REQ	BIT	F10308	HS link 9 enable/disable request
_HS10_REQ	BIT	F10309	HS link 10 enable/disable request
_HS11_REQ	BIT	F1030A	HS link 11 enable/disable request

Flag	Data type	Device	Description
_HS12_REQ	BIT	F1030B	HS link 12 enable/disable request
_HS1_REQ_NUM	BIT	F10310	HS link 1 enable/disable setting
_HS2_REQ_NUM	BIT	F10311	HS link 2 enable/disable setting
_HS3_REQ_NUM	BIT	F10312	HS link 3 enable/disable setting
_HS4_REQ_NUM	BIT	F10313	HS link 4 enable/disable setting
_HS5_REQ_NUM	BIT	F10314	HS link 5 enable/disable setting
_HS6_REQ_NUM	BIT	F10315	HS link 6 enable/disable setting
_HS7_REQ_NUM	BIT	F10316	HS link 7 enable/disable setting
_HS8_REQ_NUM	BIT	F10317	HS link 8 enable/disable setting
_HS9_REQ_NUM	BIT	F10318	HS link 9 enable/disable setting
_HS10_REQ_NUM	BIT	F10319	HS link 10 enable/disable setting
_HS11_REQ_NUM	BIT	F1031A	HS link 11 enable/disable setting
_HS12_REQ_NUM	BIT	F1031B	HS link 12 enable/disable setting
_P2P1_ENABLE_STATE	BIT	F09620	P2P1 enable/disable current state
_P2P2_ENABLE_STATE	BIT	F09621	P2P2 enable/disable current state
_P2P3_ENABLE_STATE	BIT	F09622	P2P3 enable/disable current state
_P2P4_ENABLE_STATE	BIT	F09623	P2P4 enable/disable current state
_P2P5_ENABLE_STATE	BIT	F09624	P2P5 enable/disable current state
_P2P6_ENABLE_STATE	BIT	F09625	P2P6 enable/disable current state
_P2P7_ENABLE_STATE	BIT	F09626	P2P7 enable/disable current state
_P2P8_ENABLE_STATE	BIT	F09627	P2P8 enable/disable current state
_P2P1_REQ	BIT	F10320	P2P1 enable/disable request
_P2P2_REQ	BIT	F10321	P2P2 enable/disable request
_P2P3_REQ	BIT	F10322	P2P3 enable/disable request
_P2P4_REQ	BIT	F10323	P2P4 enable/disable request
_P2P5_REQ	BIT	F10324	P2P5 enable/disable request
_P2P6_REQ	BIT	F10325	P2P6 enable/disable request
_P2P7_REQ	BIT	F10326	P2P7 enable/disable request
_P2P8_REQ	BIT	F10327	P2P8 enable/disable request
_P2P1_REQ_NUM	BIT	F10330	P2P1 enable/disable setting
_P2P2_REQ_NUM	BIT	F10331	P2P2 enable/disable setting
_P2P3_REQ_NUM	BIT	F10332	P2P3 enable/disable setting
_P2P4_REQ_NUM	BIT	F10333	P2P4 enable/disable setting
_P2P5_REQ_NUM	BIT	F10334	P2P5 enable/disable setting
_P2P6_REQ_NUM	BIT	F10335	P2P6 enable/disable setting
_P2P7_REQ_NUM	BIT	F10336	P2P7 enable/disable setting
_P2P8_REQ_NUM	BIT	F10337	P2P8 enable/disable setting

- ▶ How to enable link  
-HS link/P2P enable/disable setting flag ON → HS link/P2P enable/disable request flag ON
- ▶ How to disable link  
-HS link/P2P enable/disable setting flag OFF → HS link/P2P enable/disable request flag ON
- ▶ You can monitor the Enable/Disable state of the each link through “enable/disable current states” flag.

### 5.6 System Diagnosis

System Diagnosis function is used to display general service status and information of the communication module in Online status including link type, link information and OS version so to allow the user to precisely diagnose and debug the data Tx/Rx relation of the communication module presently used.

#### 5.6.1 Execution of the diagnosis function

Run XG5000 to connect with and then select [Online] -> [Communication module setting] -> [System Diagnosis] to display [Fig. 5.6. 2], which shows base and slot information the present module is installed on and the operation status.

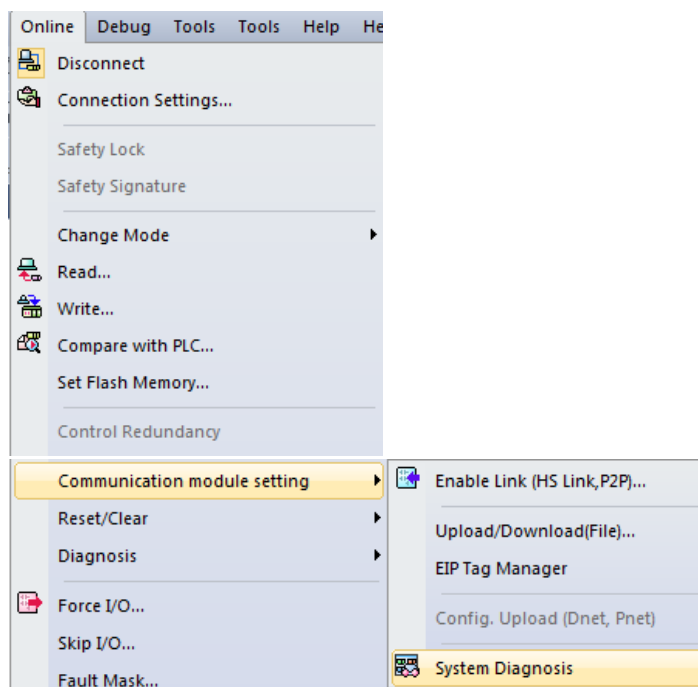

[Fig. 5.6.1] Selection of system diagnosis function

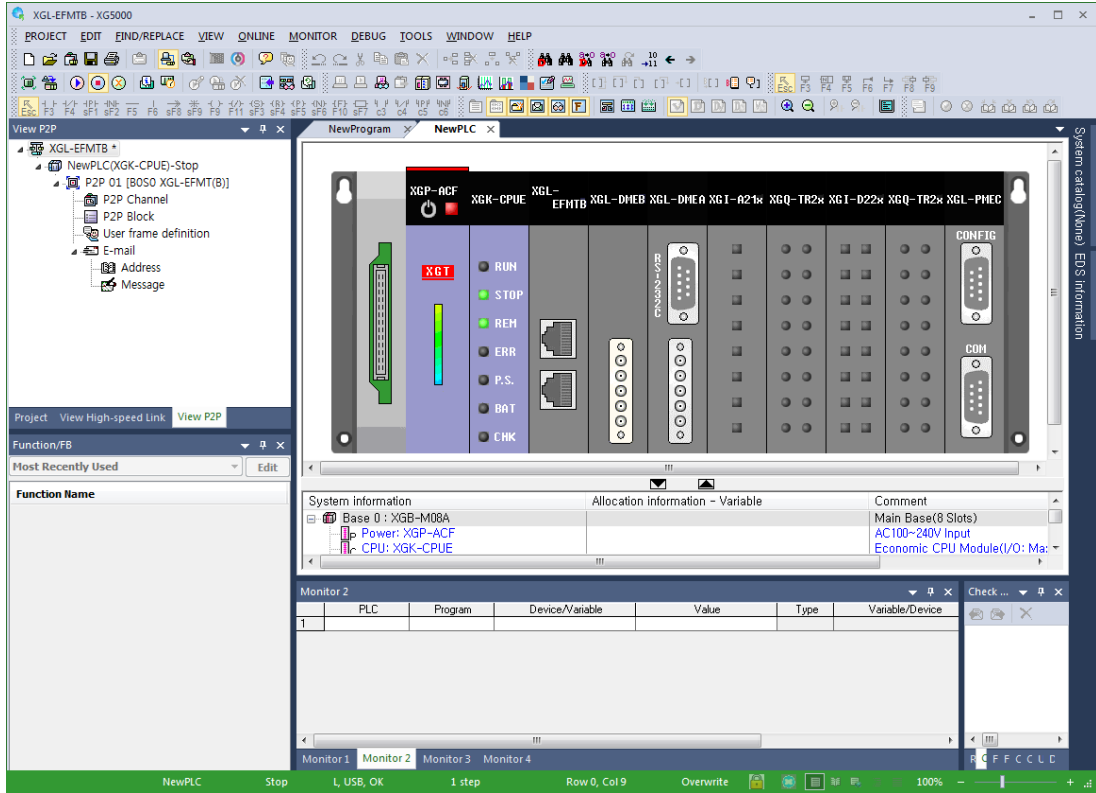

[Fig. 5.6.2] Module information of system diagnosis

### 5.6.2 Type of diagnosis functions

Through the pop-up menu as in the initial diagnosis screen [Fig. 5.6.3], system status can be diagnosed for the various communication modules. Main functions for each item are as described below in [Table 5.6.1].

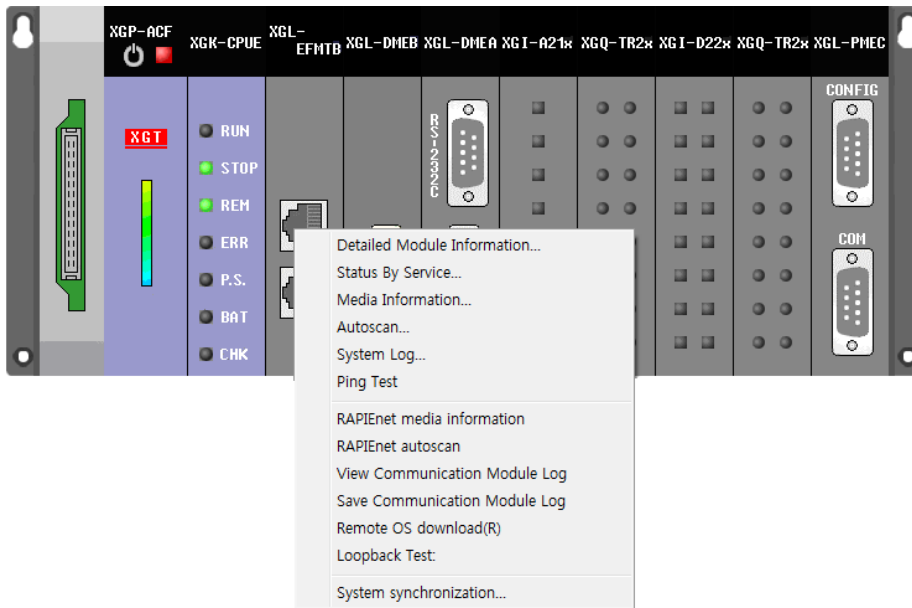

[Fig. 5.6.3] Diagnosis function pop-up of module

Classification	Description
Detailed module information	Displays communication module's basic information, H/W and communication status.
Status by service	Displays the status of dedicated communication, P2P, HS link service, etc.
Media information	Provides packet information of Tx/Rx data through media.
Ping test	Displays port connection status of other station specified on the network.
Autoscan	Provides active IP information for all the modules specified on the present network.
RAPIEnet media information (OS V6.0 or above)	Supports packet information of RAPIEnet
RAPIEnet auto scan (OS V6.0 or above)	Supports modules and configuration information on the RAPIEnet network.
Communication module history (OS V6.0 or above)	Supports event/communication history information of communication module.
Save communication module history (OS V6.0 or above)	Saves event and communication history information.
Remote OS download (OS V6.0 or above)	Updates the OS of the remote module in the network.
Loopback test (OS V6.0 or above)	It is a function to check the H / W abnormality of the local module and check loopback for each port.

[Table 5.6.1] Detailed diagnosis services

### (1) Communication module information

Communication module information shows basic information such as base information, High-speed link station No., IP information, etc. in addition to media and start status of the communication service, through which the user can confirm that the communication module normally transmits and receives the data.

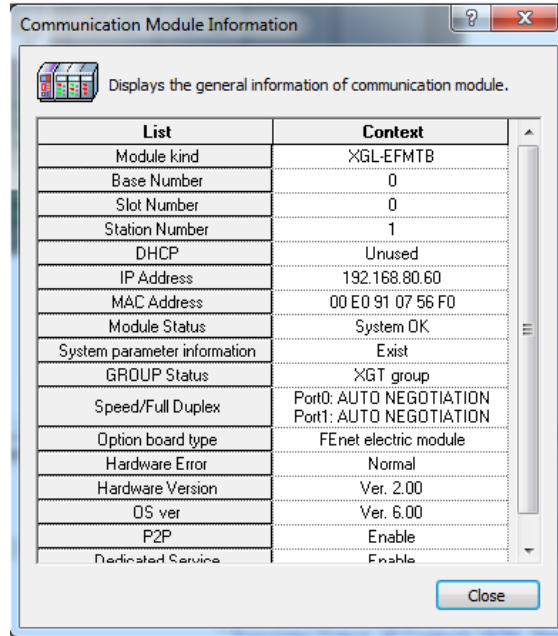

[Fig. 5.6.4] Communication module information

(2) Service status

Service status of the communication module is classified into 3 (dedicated communication, P2P and High-speed link), which show detailed information on the respective communication services.

1) Dedicated Service

Displays the service status of MMI or HMI dedicated protocol by means of higher client, and monitors Tx/Rx data and errors of the specified IP.

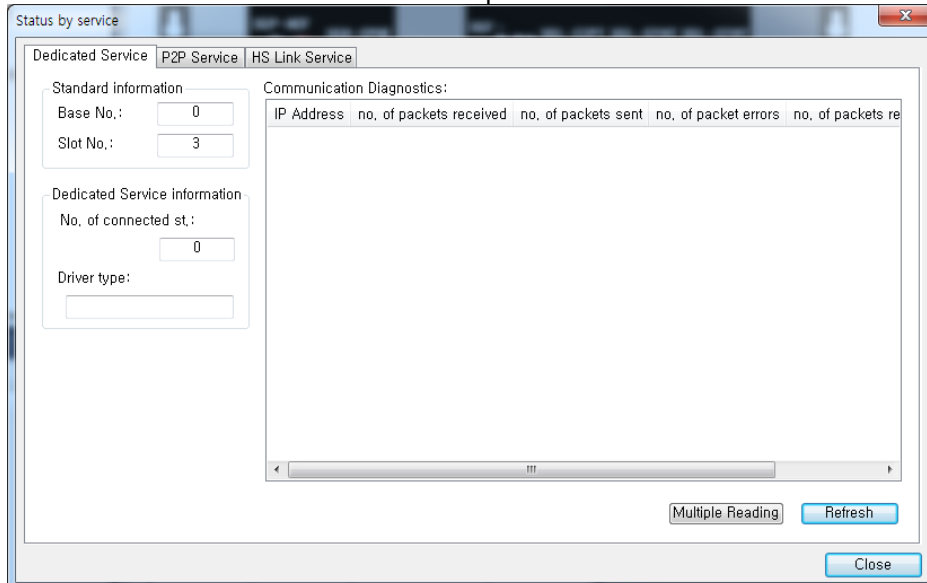

[Fig. 5.6.5] Dedicated service monitor

2) P2P Service

Displays detailed information on the user defined service executed, and checks normal service to read if P2P parameters are set and enabled, where real time monitoring is available with Individual Read or Continuous Read specified on the menu.

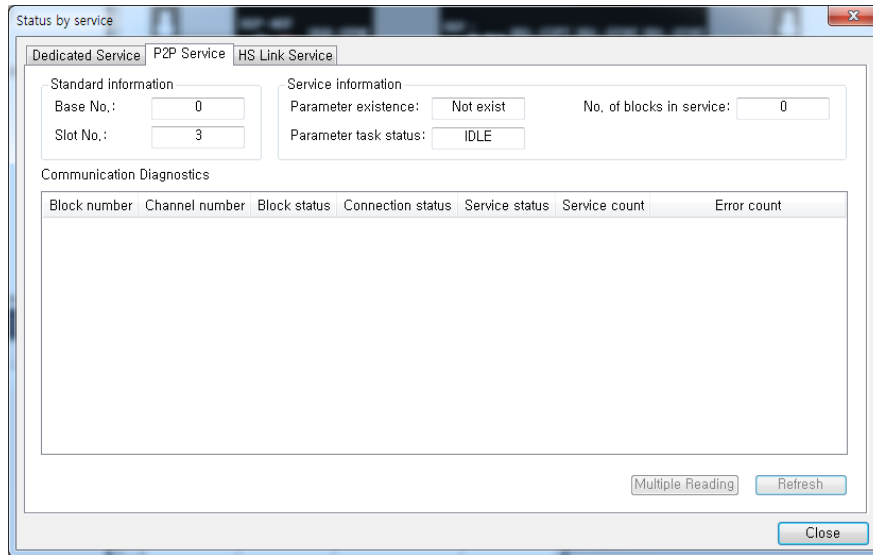

[Fig. 5.6.6] P2P service monitor

3) HS Link Service

Monitor flags of respective parameters for High-speed link setting data. Run link, link trouble and individual information can be all monitored by High-speed link service.

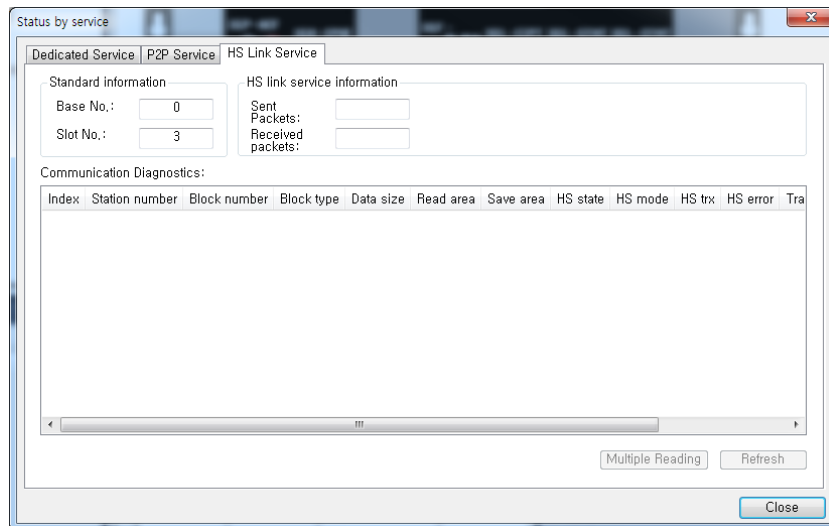

[Fig. 5.6.7] High-speed link service monitor

(3) Media Information

Displays the packet information input through the media.

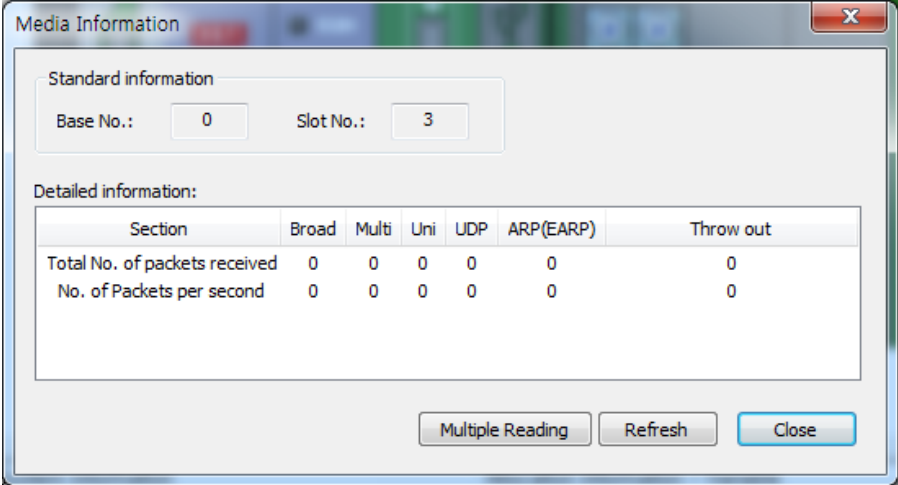

[Fig. 5.6.8] Media information

(4) Ping Test

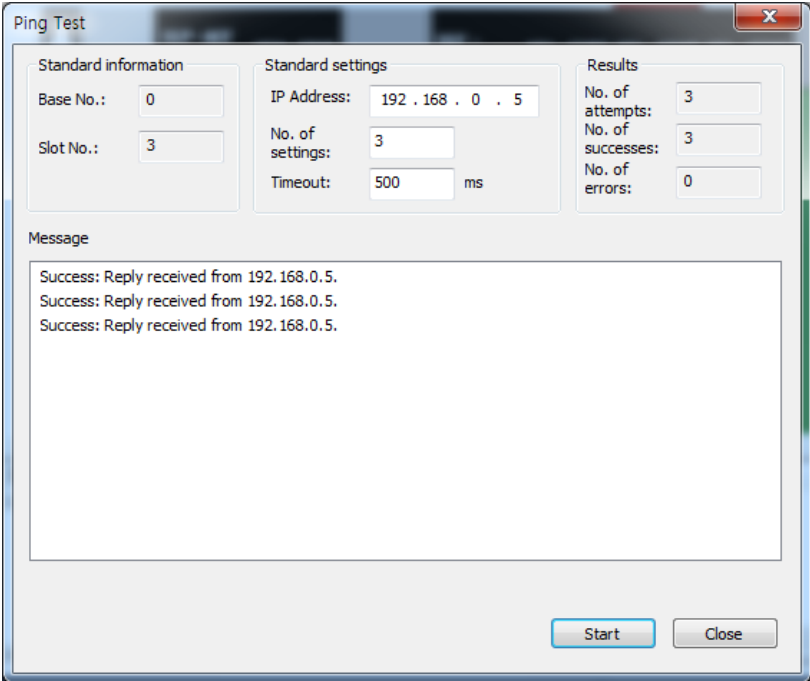

[Fig 5.6.9] Ping Test monitor for the destination station number

(5) Auto scan

Display the link interface status of the whole network. The service status of FEnet I/F module connected with the public network is displayed as simple as shown in the diagram.

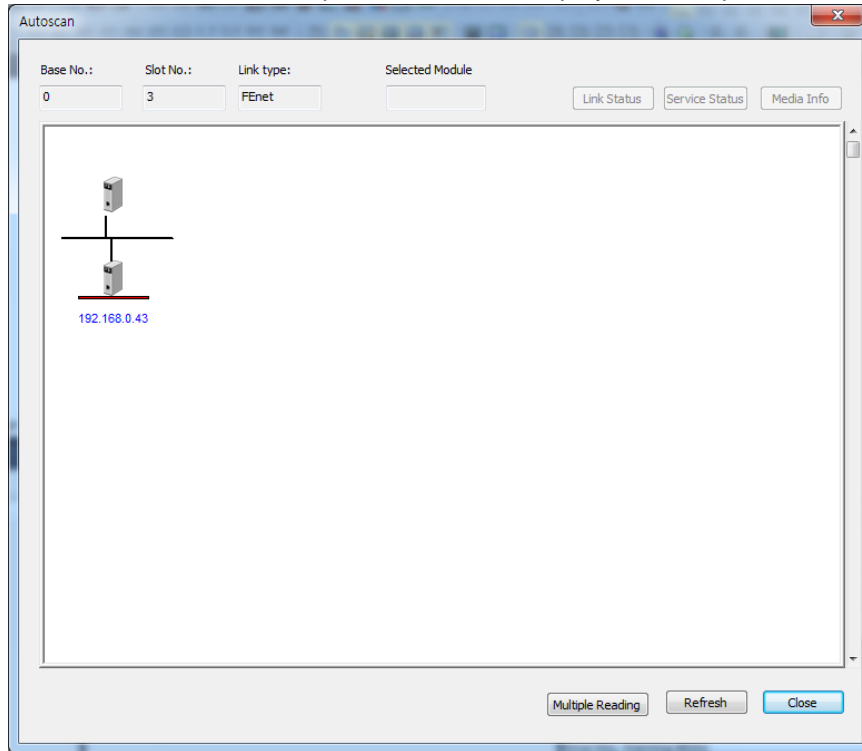

[Fig. 5.6.10] Network Auto scan

(6) Media information of RAPIEnet (OS V6.0 or above)

Indicates the status of the link interface across the RAPIEnet network.

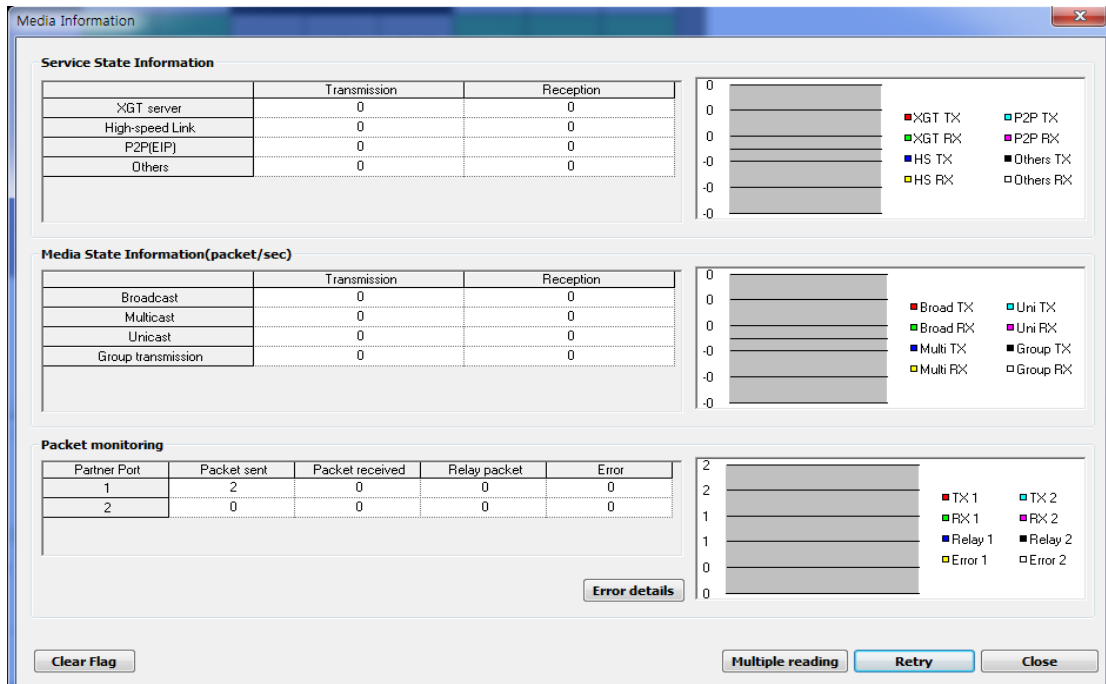

[Fig 5.6.11] Media information of RAPIEnet

(7) Auto scan of RAPIEnet (OS v6.0 or above)  
Indicates the status of the link interface across the RAPIEnet network.

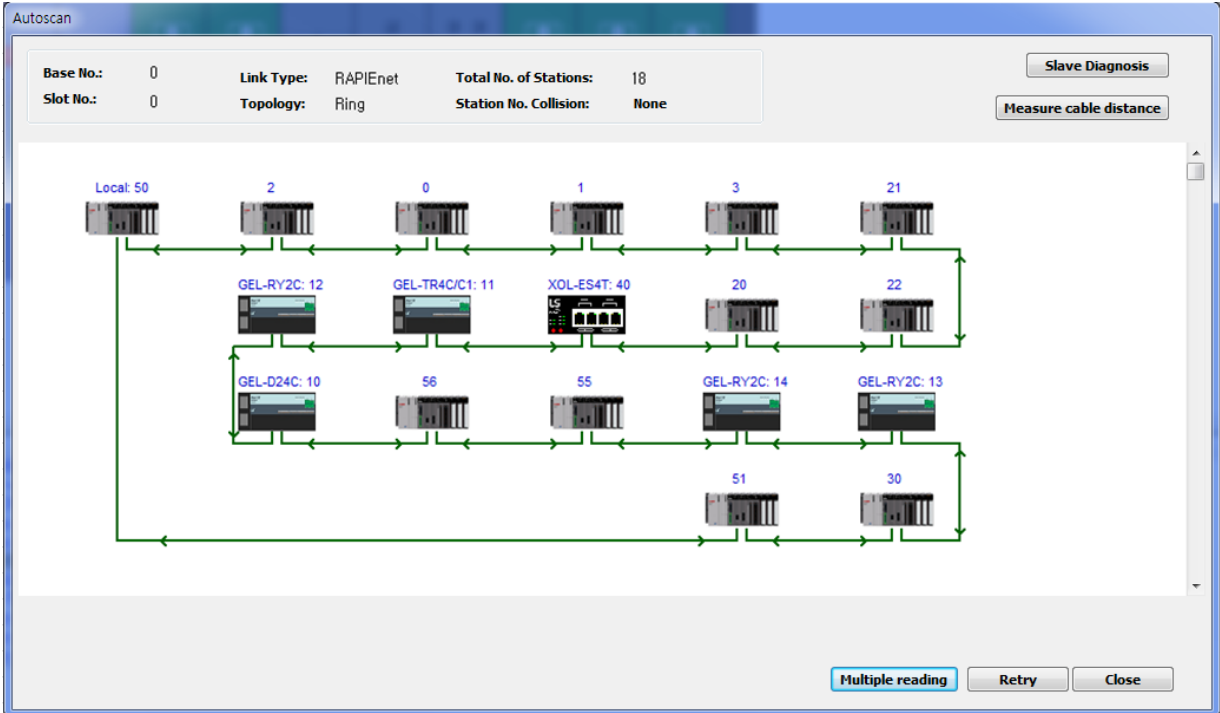

[Fig 5.6.12] Auto scan of RAPIEnet

(8) View Communication Module Log (OS v6.0 or above)  
Indicates event and communication history occurred in communication module.

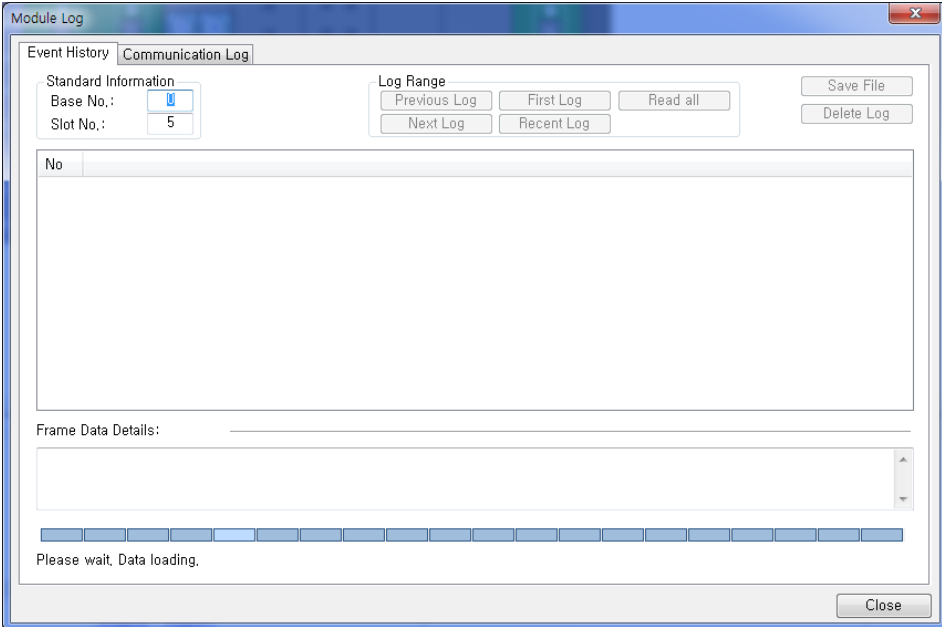

[Fig 5.6.13] View Communication Module Log

- (9) Remote OS download (OS v6.0 or above)  
Updates the OS of the remote communication module.

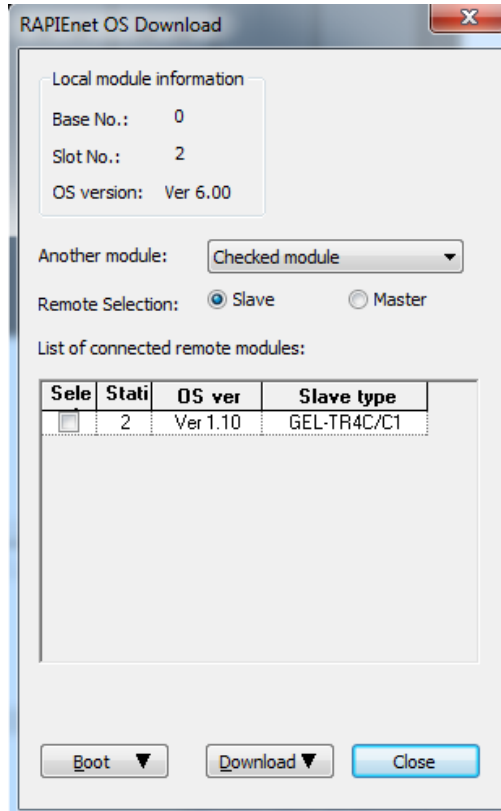

[Fig 5.6.14] Remote OS download

- (9) Loopback test (OS v6.0 or above)  
Tests the H/W abnormality through the loopback test of the Ethernet I / F of the local communication module.

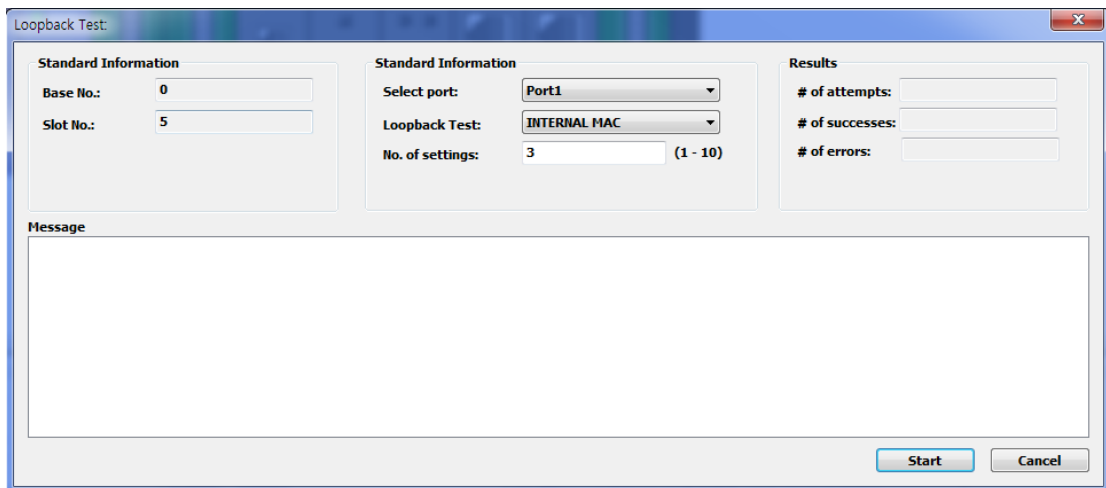

[Fig 5.6.15] Loopback test

# Chapter 6 High-speed Link Service

## 6.1 Introduction

High-speed link (HS link) is a communication method between XGT PLC communication modules to send and receive data with High-speed link parameters setting, which can also allow the user to use XG5000 to exchange data with parameters setting of Send/Receive data size, communication period, Send/Receive area and area to save through its data transmission service function.

However, since High-speed link service uses the subnet broad service, it may have an influence on other communication modules which use the identical network. Thus, setting block size as near to the maximum Send/Receive size (400 bytes or 200 words) as available per High-speed link block is recommended for the user to obtain the greatest communication efficiency with the lowest influence on other modules so to reduce the sum of blocks. In order to make use of all functions, surely specify the basic communication parameters in the status of communication available.

High-speed link functions are specified as below;

1) High-speed link block setting function

- (1) If there are many Send/Receive areas, up to 128 blocks can be setup.
- (2) 200 words are available for a block.

2) Communication period setting function

Send/Receive period can be setup per block by user for the areas where especially fast Tx/Rx is required and not required respectively in a Tx/Rx period of 20ms to 10 sec.

(OS v5.0 or above: The minimum transmission cycle is 5ms)

3) Send/Receive area setting function

Send/Receive area can be setup per data block by user according to memory address specified.

4) Providing function of High-speed link information

Reliable communication system can be easily configured by providing High-speed link information for user via the user keyword.

[Table 6.1.1] shows the data capacity of High-speed link communication whose basic unit is 1 word.

Classification	Max. communication words	Max. Send words	Max. blocks	Max. words per block
XGL-EFMT(B)	25,600	6,400	128 (0-127)	200

[Table 6.1.1] Max. Communication data capacity

**6.2 High-speed Link Send/Receive Data Processing**

High-speed link application will be described below with the example where FENet I/F modules of the stations No.0 and No.1 are to send and receive the data between each other.

The station No.0 transmits the data of 10 words from M0000 to M0009 with block No.0 and the received data, transmitted by the station No.1, is saved on M0010. The station No.1 receives data of 10 words from the station No.0 to save on M0030, and transmits the data of 10 words from M0020 to M0029 word with block No.1.

There are 32 blocks for Send data and 64 blocks for Rx data in the High-speed link parameters. The block number can be set 0~31 for transmission or 0~63 for receiving. The Send side needs only to decide which data to read and which block number to send to without setting the destination station No. when transmitting the data is setup.

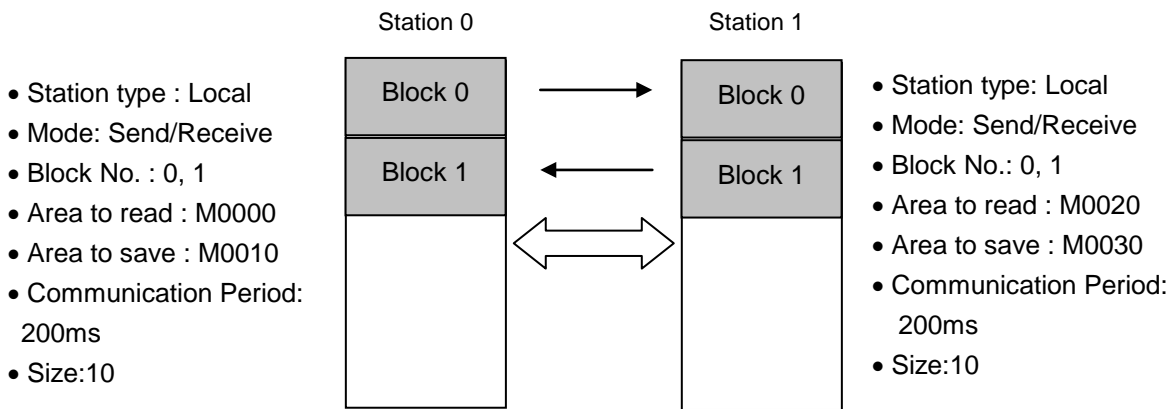

[Table 6.2.1] Diagram of High-speed link processing blocks

### 6.3 Operation Sequence through High-speed Link

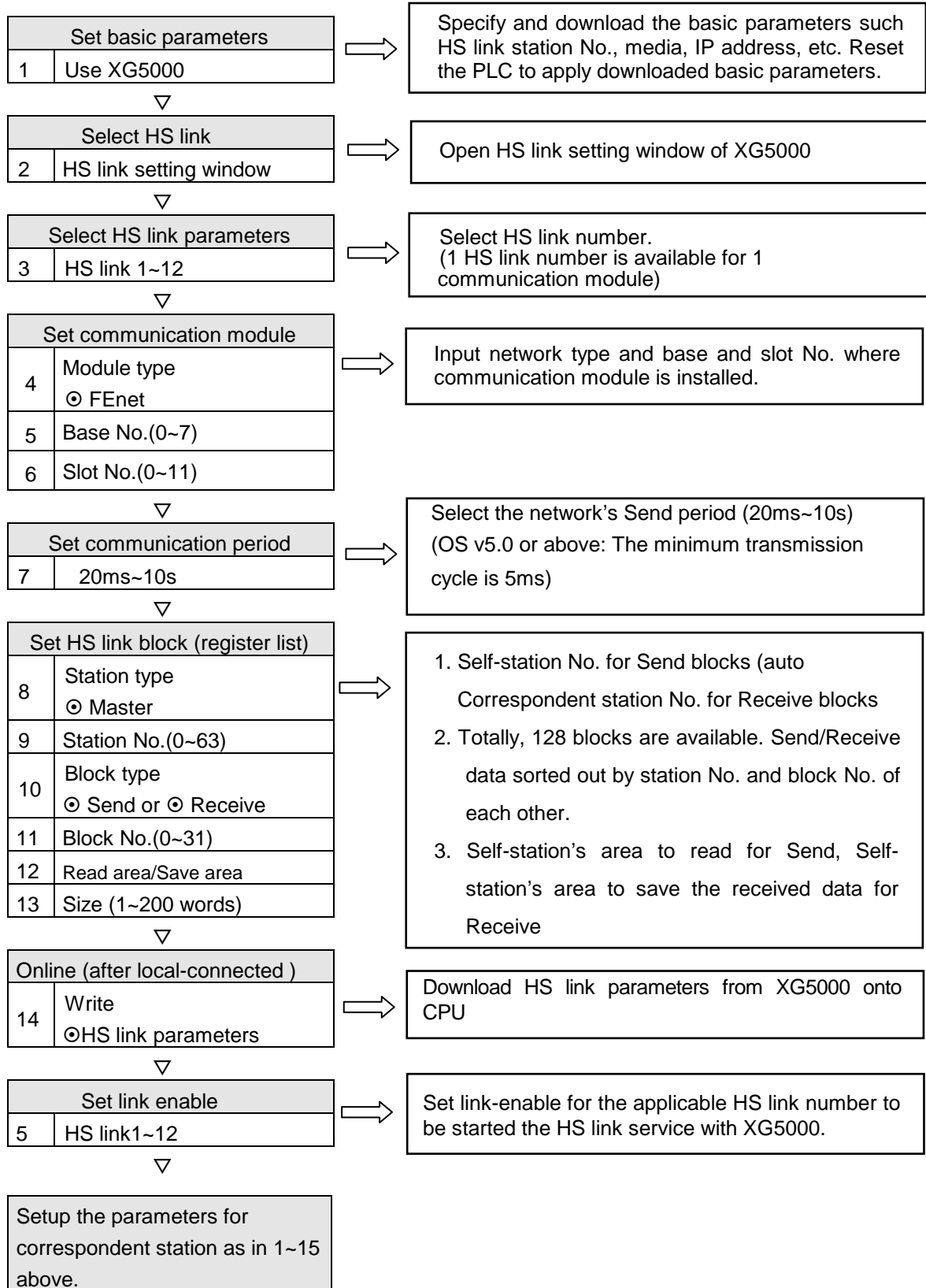

## 6.4 High-speed Link Parameters Settings

High-speed link parameters shall be setup by the means of setup respective items for High-speed link after selecting High-speed link parameter number on the Hs link screen of XG5000. The setting steps and the functions of respective items are explained below.

### 6.4.1 Execution of XG5000

The initial screen of XG5000 will be displayed as shown below [Fig. 6.4.1] when XG5000 is executed.

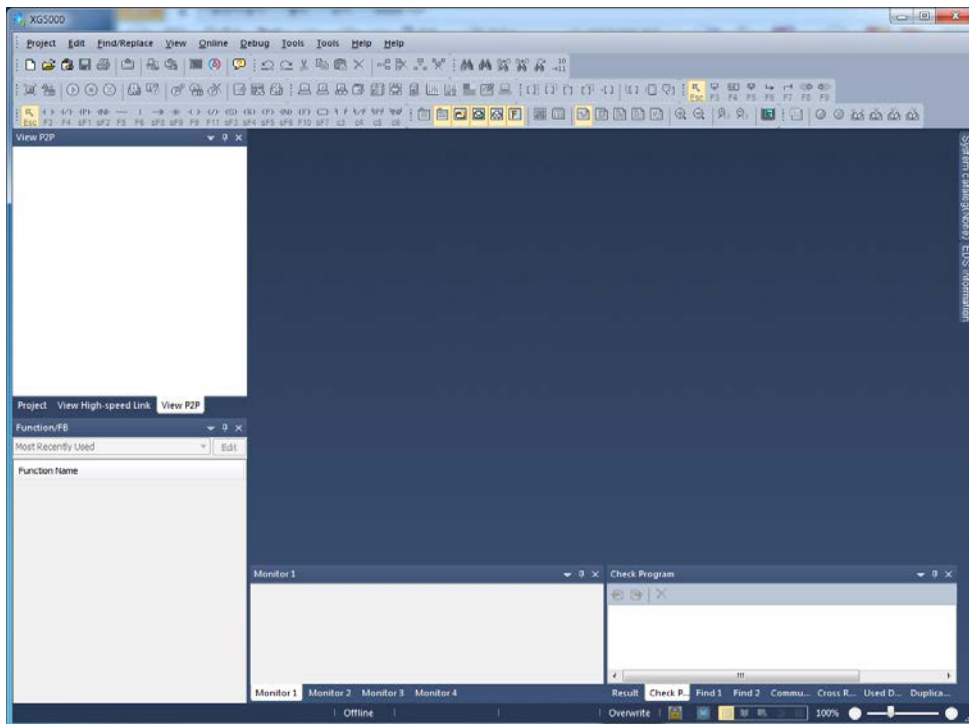

[Fig. 6.4.1] Initial screen of XG5000

### 6.4.2 Standard settings (Module)

(1) Setting the communication module

Communication module setting can be registered via off-line or Online.  
Refer to Chapter 5 XG5000 program for more details.

(2) Downloading standard settings

Select [Online] - [Write] to open the 'Write parameter' window of [Fig. 6.4.2]. Check applicable standard settings and click [OK] button.

**After standard settings are downloaded, surely let PLC power turn off and on or reset. If the communication module is not reset, the new communication parameters information will not be applied.**

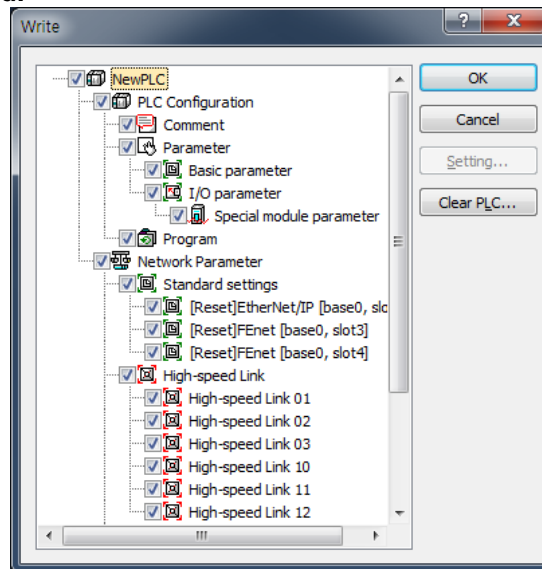

[Fig. 6.4.2] Write Parameter window

### 6.4.3 High-speed Link Parameters (HsLink)

#### (1) Initial screen setting of High-speed link parameters

Select HsLink window of XG5000 to display the window where High-speed link parameters can be setup. 12 High-speed links are available for XGT series PLC. And parameters setting are available for the communication modules installed on the basic or extended base.

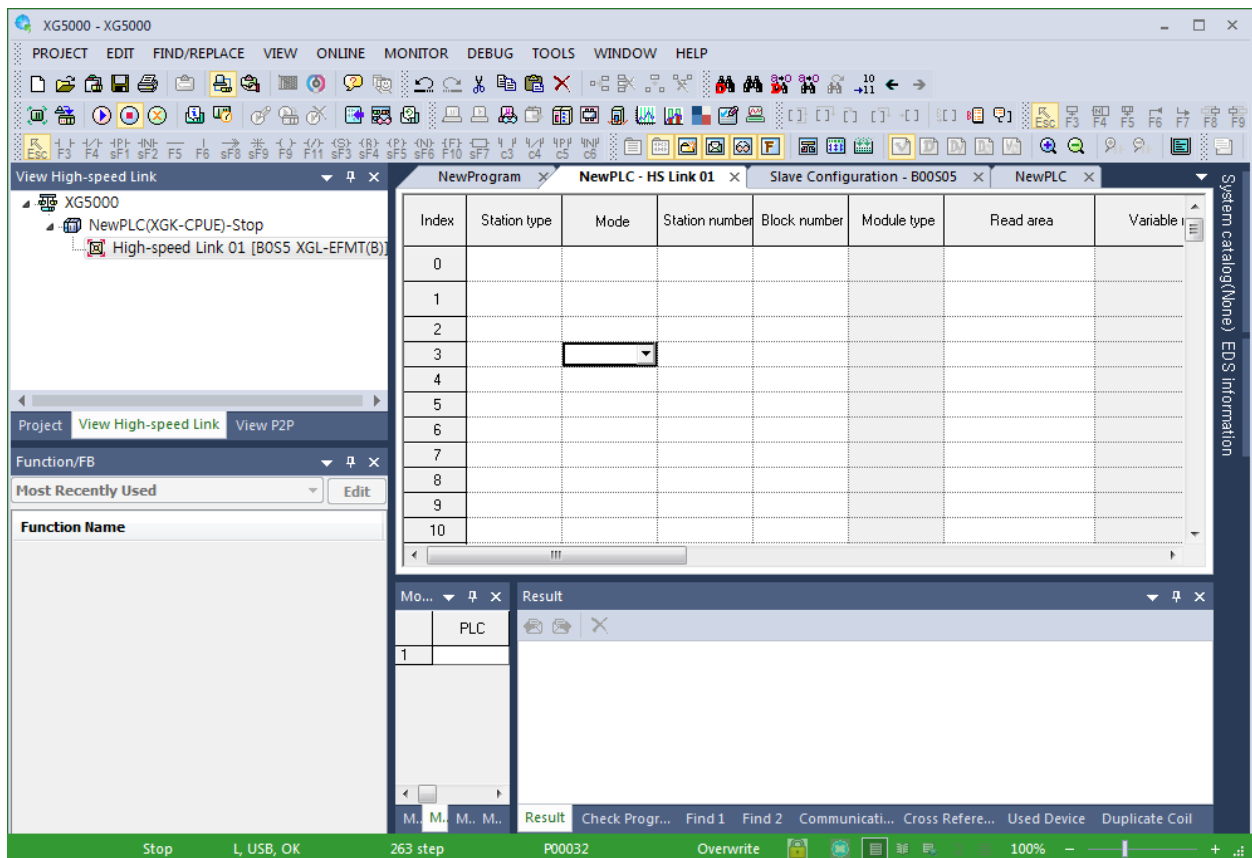

[Fig. 6.4.3] Initial screen of High-speed link settings

### (2) Communication Module Settings and Communication period settings

Double-click one of the High-speed links 01~12 on the [Fig.6.4.3] screen to open the Communication Module setting dialog box depicted in [Fig. 6.4.4] to setup communication module and communication period.

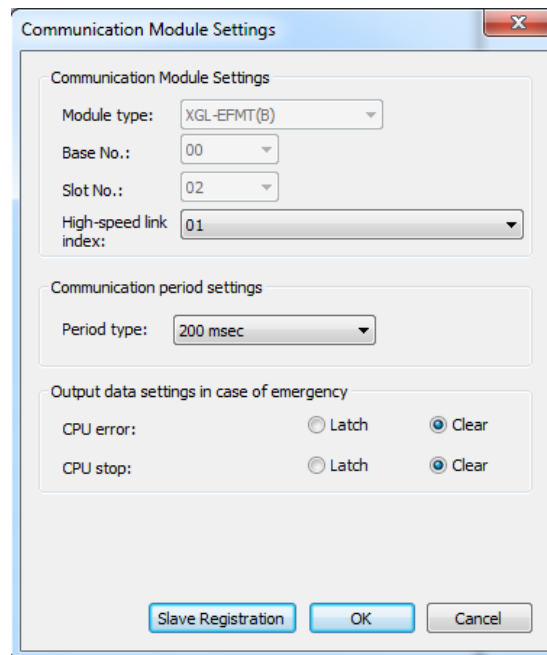

[Fig. 6.4.4] Communication module setting

Set the applicable communication module and communication period in the dialog box.

Item		Description
Communication module settings	Module type	Select the installed communication module type.
	Base No.	Select the base number where applicable FENet module is installed.
	Slot No.	Select the slot number where applicable FENet module is installed.
Communication period settings	Period type	<ul style="list-style-type: none"> <li>- High-speed link service is used to send and receive data by user defined parameters when the execution of PLC program is ended. Thus, if the scan time of PLC program is as short as <math>ms</math> or less, the communication data will be increased since the communication module sends data at the end of every scan, which will cause decreased efficiency of the whole communication system. In order to prevent this, the communication is controlled by the specified communication period whose setting range is <math>20\ ms \sim 10\ sec</math>, which will be automatically set to default of <math>200\ ms</math> if not specified.</li> <li>- The communication period will be applied for Send blocks.</li> <li>- The communication period will be applied identically to all the Send blocks included in the same High-speed link parameter number.</li> </ul>

Output data setup in case of emergency	Latch	Maintain and send the latest data received from CPU. It is seen that it is cleared if CPU sends data as 0 even though latch is set. Make sure to check the emergency output data setting of CPU.
	Clear	It sends by setting received High-speed Link data as 0 in ignoring data from CPU. If emergency data is set as 'clear' in emergency output data setting of XG5000 High-speed Link module setting even though emergency output data setting of device area of High-speed Link sending part is set as latch in CPU, the data set as 0 is sent. Make sure to set it after checking desired operation.
Slave registration (OS v6.0 or above)		Selects RAPIenet Smart IO to register in high speed link.

[Table 6.4.2] Setting of communication module and communication period

(3) Add Slave

Select [Add item] →[Add slave] menu by clicking on the right mouse button after selecting XGL-EFMTB registered as new on the network configuration screen. Or, select [Project] →[Add item] →[Add slave] of XG5000 menu to perform the same function.

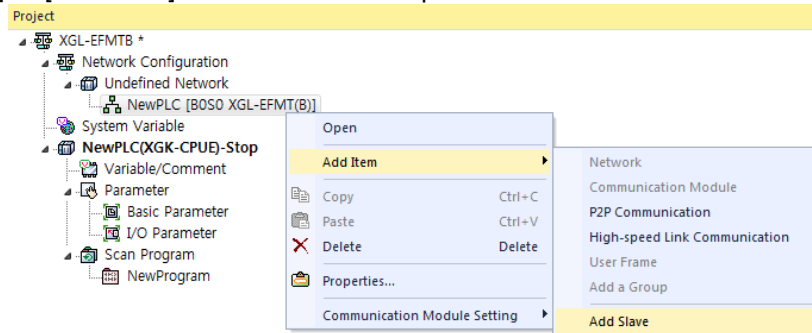

[Fig 6.4.5] Add Slave Configuration

(4) Slave Configuration window

Smart I/O RAPIenet module is a slave module, and thus it requires parameter settings by each slave in order to communicate with a master module. The configuration window for slave setting is as follows.

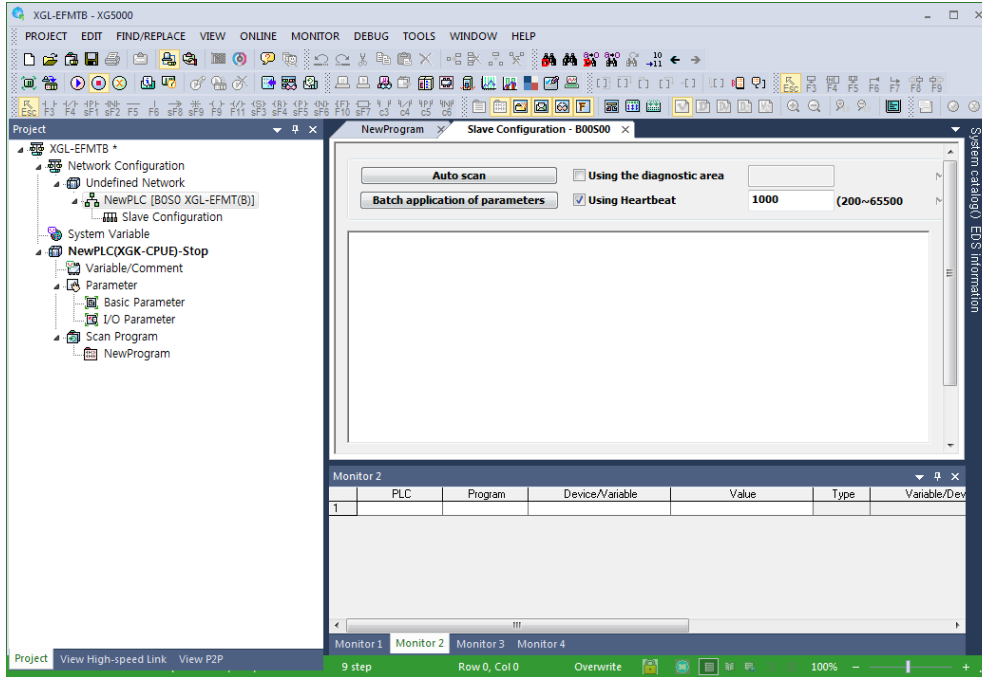

[Fig 6.4.6] Slave Configuration window

### (5) System catalog (Slave registration)

It includes the information about module parameter and basic parameter on the Smart I/O RAPIenet module. Double click the Smart I/O to be used or drag-in to the slave configuration window, and the parameter setting window for the module is created.

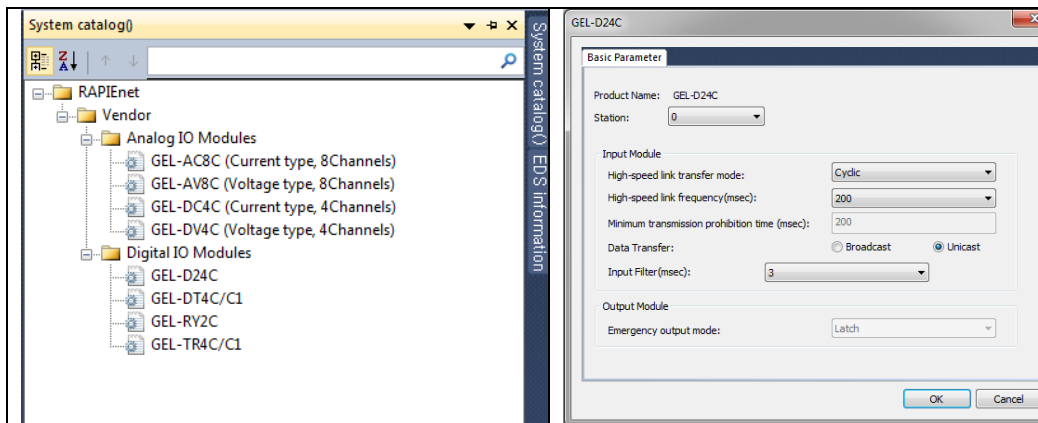

[Fig 6.4.7] System catalog and Example of Slave parameter setting window

### (6) Auto scan (Slave registration)

It is an item which is enabled only when XG5000 is connected to the PLC online. Smart I/O connected to the RAPIenet master module can be added by clicking Auto Scan. Click Add Slave of Auto Scan, and the slave list available on the network is created.

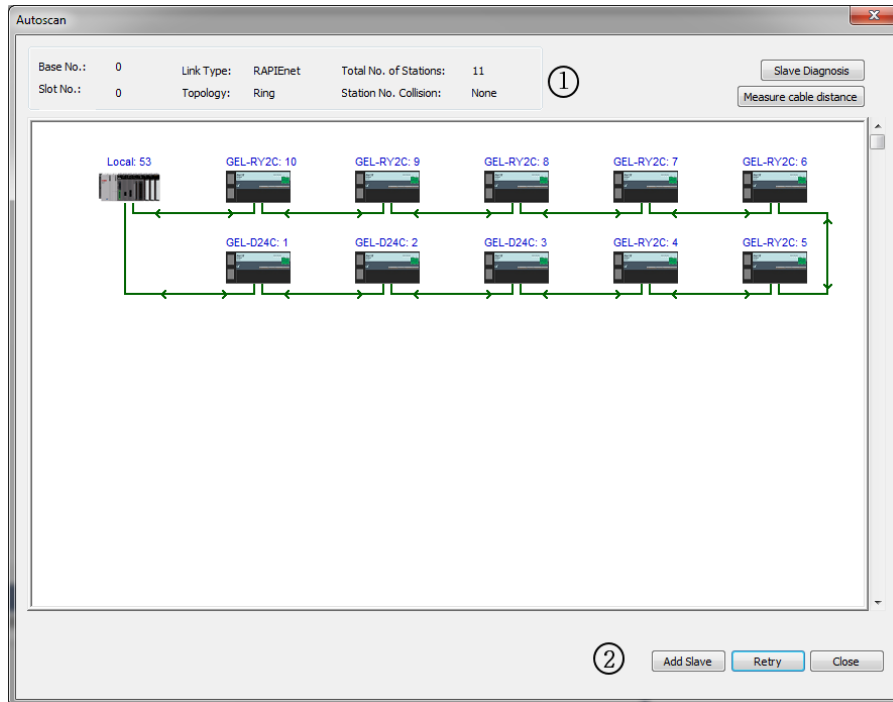

[Fig 6.4.8] Example of Scan

Division	Name	Meaning
1	Basic Information	It refers to the network configuration information of the master station No. (Local).
2	Add Slave	It is a function to select the module intended to controlled among Smart I/O modules that exist within the network in the master station No.(Local).

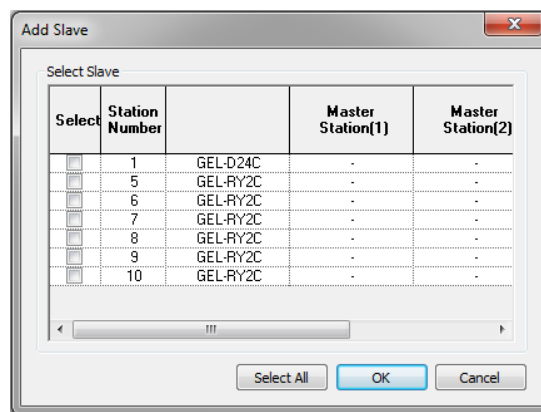

[Fig 6.4.9] Add slaves

**Notes**

(1) When you click the Slave Add button, only the Smart I/O in which parameters are not set can be added. If the slave you want to select from [Add Slave] window is controlled by another master module, the slave cannot be selected.

(7) Batch application of parameters

It is a function used for batch application depending on the module type. It is convenient to set parameters since batch application of parameters for each module is possible in the system constituted by the same kind of Smart I/O.

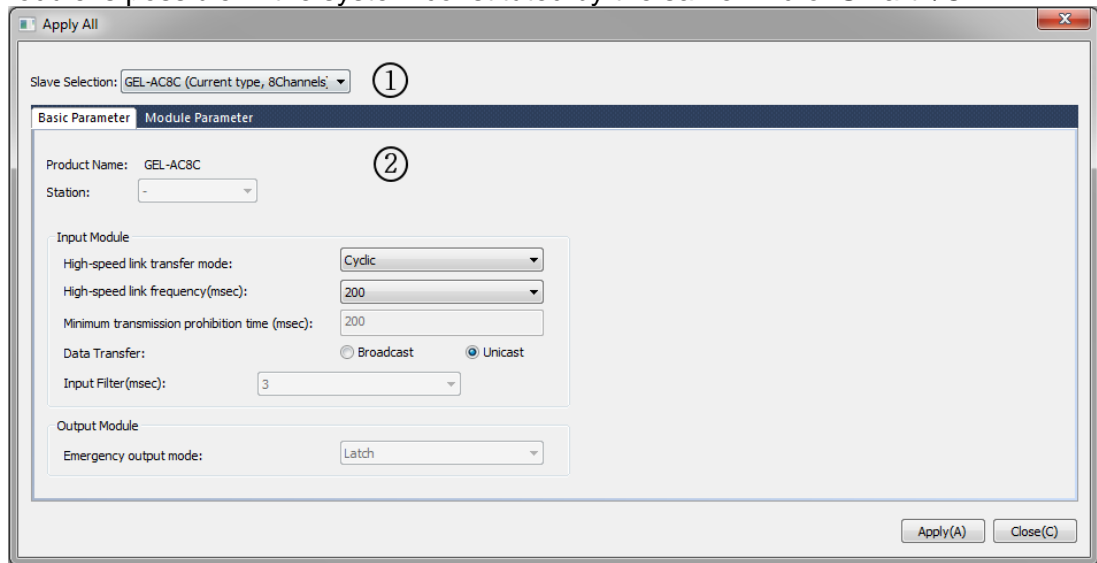

[Fig 6.4.10] Batch application of parameters (Basic parameter)

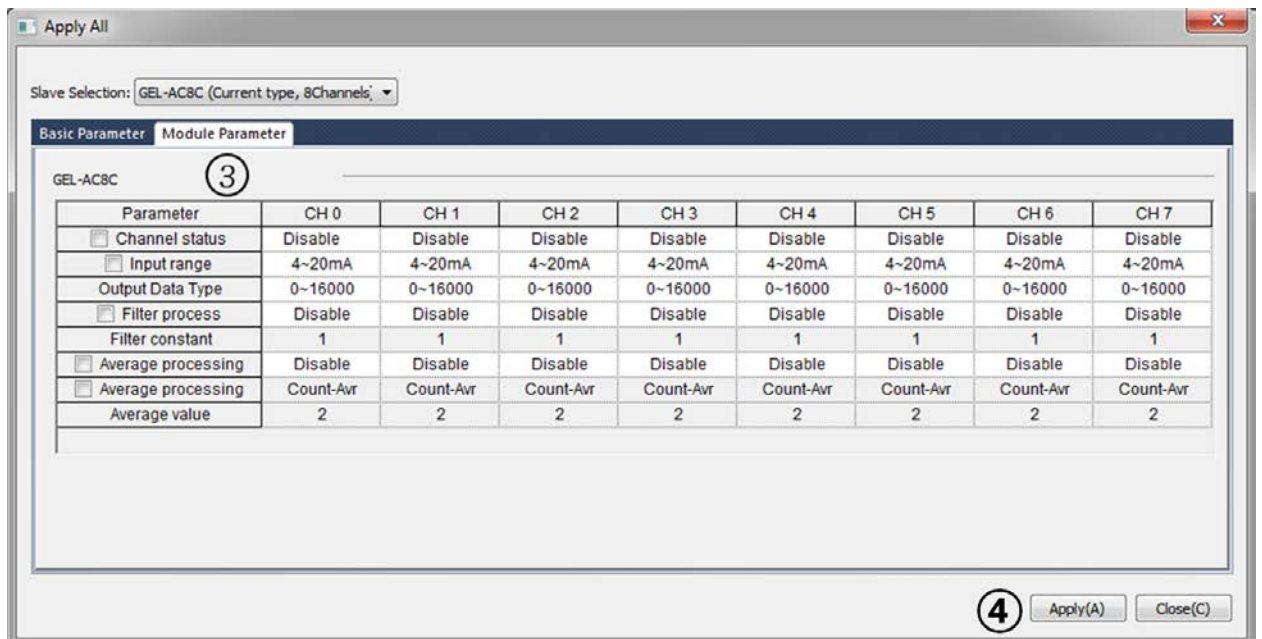

[Fig 6.4.11] Batch application of parameters (Module parameter)

Functions for each menu are as follows.

Division	Name	Meaning
1	Slave selection	It refers to the module in which the parameter batch application function is to be applied.
2	Basic parameter	It means the basic parameter of the module.
3	Module parameter	It means the module parameter. The module parameter is enabled only if the analog I/O module is selected.

4	Apply	The set parameter is applied.
---	-------	-------------------------------

(8) Diagnostic use

Diagnostic area use function is to transmit the diagnostic information provided by the slave module to the PLC device area. Check the diagnostic area use and enter the starting address of the PLC device in which the diagnostic information is stored, and the diagnostic area of 1 word per slave is automatically allocated to the high-speed link block.

(9) Heartbeat use

It is a function to check if network elimination between Smart I/O and RAPIEnet master occurs. The presence within the network can be confirmed by checking heartbeat signals at set time intervals. The heartbeat period can be set up to 200~65500msec, and the heart beat error information for each Smart I/O can be provided if the diagnostic area use is checked.

(10) Master module station No

It is a function that is enabled when Smart I/O is used in the XGR CPU and refers to the station number of the master module mounted on the side of standby and master of the XGR CPU.

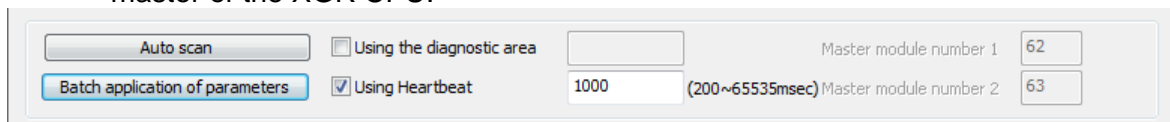

[Fig 6.4.12] Slave modules common parameter

(11) Basic parameter setting items

Basic parameter means the basic parameter settings for the communication between Smart I/O module and master, and the setting method is to double click or drag in the slave module to the slave module from the catalog menu of the slave configuration window. Basic parameter are largely divided into the station No. information, input module and output module setting items, and the setting items are automatically enabled, depending on the module type.

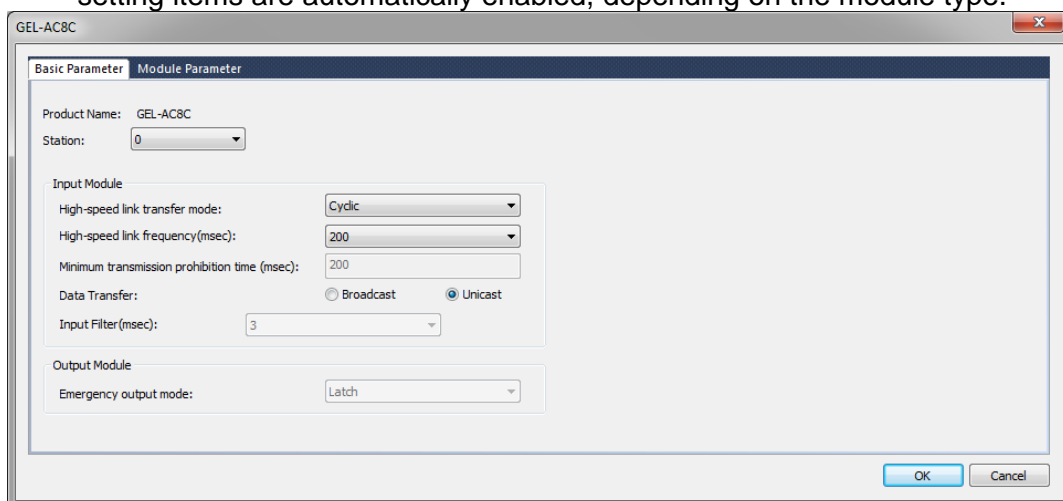

[Fig 6.4.13] Example of basic parameter (GEL-AC8C)

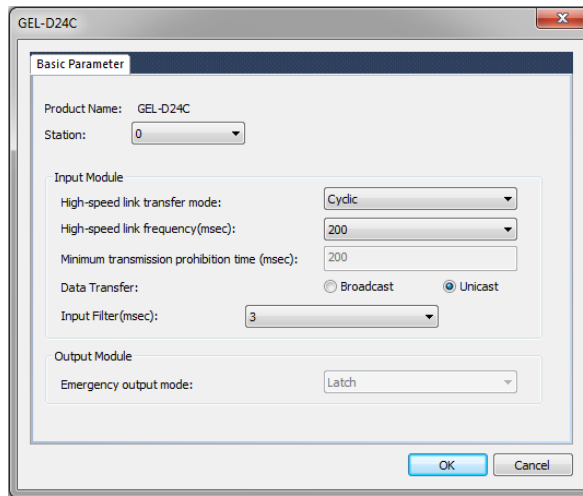

[Fig 6.4.14] Example of basic parameter (GEL-D24C)

\*Product name: It displays the product name of the Smart I/O module.

\*Station No: It is the setting menu for the station No. of the Smart I/O, and the setting range is from 0 to 63.

\*High-speed link transmission mode

It is an item that is enabled only when the module of input type is selected and can be set to Cyclic and CoS..

Name	Meaning	Remarks
Cyclic	It is used if the data is transmitted periodically.	Default value
CoS	It is used if the data is transmitted only when the input status changes. In case the change of data is slow, the network load can be reduced by applying the CoS method.	

\* High-speed link transmission (Input data)

It is an item that is enabled only if the high-speed link mode is Cyclic mode means the transmission cycle in the Cyclic mode of the input module. The transmission cycle is as follows.

High-speed link transmission cycle (msec)	Reference
5	-
10	-
20	-
50	-
100	-
200	Default value
500	-
1000	-

The transmission cycle of the output module follows the data transmission cycle of the high-speed link.

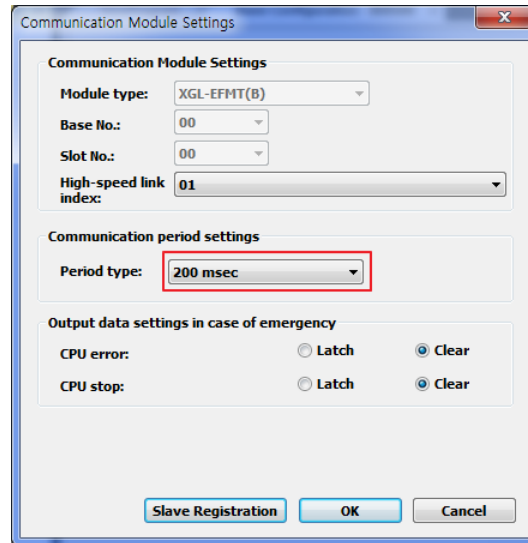

\* Minimum transmission prohibition time

It is a function that is enabled when the high-speed link transmission mode is CoS, and the time means the minimum interval for transmission in the CoS mode. Since if the non-periodical data transmission occurs frequently, it affects the network load of the entire system, the data is transmitted only if the input value is changed to more than the setting time, when the data of input module occurs non-periodically.

### Notes

1. Examples of network load calculations according to the minimum transmission prohibition time

If the data of the input module is changed to the unit of 2msec

1) When the minimum transmission prohibition time is set to 2msec

(1) Packets per second(pps)=  $1/0.002 = 500\text{pps}$

(2) 5,000pps(XGL-EIMT allowable packet amount(3,600pps)exceeded) when 10 units are configured with the module of the same condition

2) When the minimum transmission prohibition time is set to 200ms

(1) Packets per second(pps)=  $1/0.2 = 5\text{pps}$

(2) 50pps when 10 units are configured with the module of the same condition

2. If the data change cycle of the input module is less than the minimum transmission cycle (5msec), it is recommended to select Cyclic mode as the high-speed link transmission mode for stable system operations.

\*Input filter

This function is enabled only in case of the digital input module, and it supports the input filter function to prevent the processing of invalid values caused by external noise. It means that only when the data is maintained at more than the input filter value, it is processed into valid data, and it is required to set the input filter value in consideration of the use environment.

Setting range of input filter (msec)	Reference
1	-
3	Default Value
5	-
7	-
10	-
20	-
70	-
100	-

### \*Emergency output module

It is a function that is enabled only in case of the output module type. When the network configuration is disconnected physically during normal communication with master module, the existing output data can be set to latch mode and clear mode.

Name	Meaning	Reference
Latch	It maintains the existing output module when the communication is physically disconnected with the master module.	-
Clear	It initializes the existing output data to 0 when the communication is physically disconnected with the master module.	Default value

### (12) High-speed link parameters settings

Click [OK] on [Fig.6.4.4] screen to display [Fig.6.4.5] of 'HS link block registration' window.

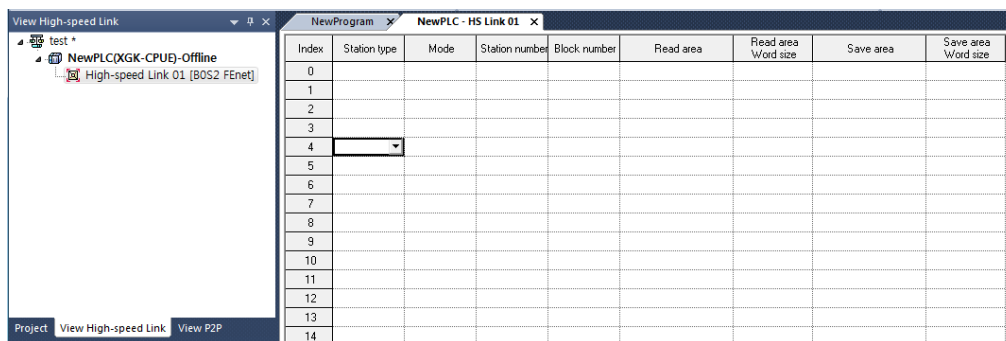

[Fig. 6.4.15] HS link block registration screen.

### (13) High speed link block setting (Generic)

To register the High-speed Link parameter, double-click the registration window with the left mouse button to open the [Figure 6.4.6] screen.

Index	Station type	Mode	Station number	Block number	Module type	Read area	Variable name	Variable name comment	Read area Word size	Save area	Variable name	Variable name comment	Save area Word size	Diagnostic information device
0	FEnet	1. Send	0	0		M0000			1					
1	FEnet	2. Receive	1	1						M0100			1	
2	FEnet	2. Receive	2	2						M0110			1	
3	FEnet	2. Receive	3	3						M0120			1	
4														
5														

[Fig 6.4.16] High speed link parameter setting screen

### (14) High-speed link block setting (slave)

High speed link data communication is only possible when Smart I / O is registered in high speed link block.

There are two slave registration methods to apply to high speed link block.

1. Register slave in [Communication module setting] menu.
2. Apply [Slave Registration] in High-speed link block.
  - Slave registration in communication module setting menu
    - [Communication Module Settings] -> Click [Slave Registration] and then [Apply RAPIEnet Slave Configuration] window will appear.
    - Select the slave you want to apply and click Apply.
    - Double-click [High-speed link 01] to check whether the selected Smart I/O is displayed in the High-speed link block window.

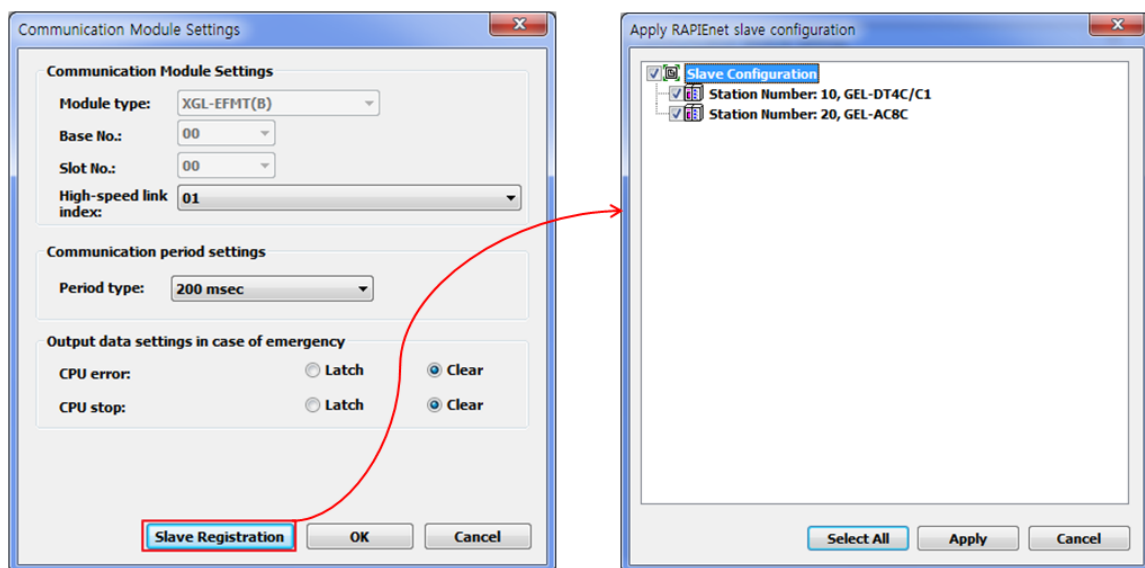

### Notes

When changing slave items in High-speed Link block due to network system change, click Slave Registration to select the slave to be used and click Apply.

- Slave registration in high speed link block
  - [Project Window] -> Double Click [High-speed Link 01]
  - Select an arbitrary block of High-speed Link block, right-click and select [Slave Registration]
  - Select the slave you want to apply and click Apply.

# Chapter 6 High-speed Link Service

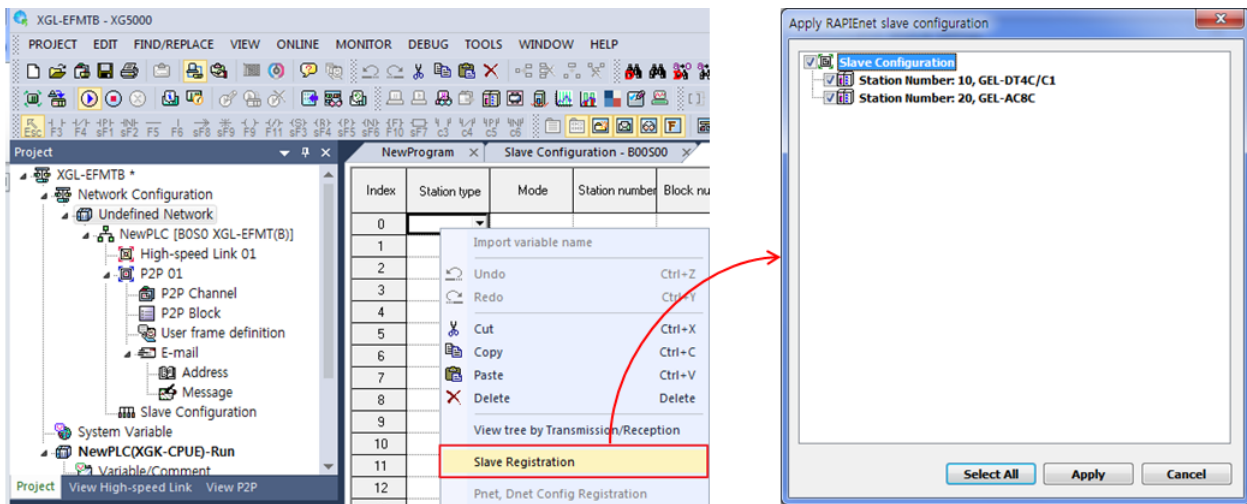

**Notes**

When changing slave items in High-speed Link block due to network system change, click Slave Registration to select the slave to be used and click Apply.

Classification		Description
Station type	Master	FEnet I/F module operates as master. Slave function is not supported.
Mode	Send	Transmits data.
	Receive	Receives data.
Station number	Native/ Destination Station No	Automatically, The High-speed link station number of self-station will be setup for Send blocks. Setup the High-speed link station number of correspondent station for Receive blocks. Available station No. for High-speed link with FEnet I/F module is '0~63'. Duplicated number is not allowed for station numbers of FEnet I/F modules included in the identical network since it is a specific number to discriminate FEnet I/F modules in the network system.
Block No.	Block number	Used to specify Send/Receive blocks.
Read area	Address	The data memory address where the data to be transmitted is stored. Available memory area 1) XGK: P, M, K, F, T, C, U, Z, L, N, D, R, ZR 2) XGI/XGR: I, Q, M, L, K, U, R, W, F Refer to the list of XGT CPU memory device in appendix for available range of each memory area.
Read area Word size	Size (Word)	The size of data to be transmitted in word unit.

Save area	Address	The data memory address to save the received data which is transmitted by the destination station. 1) XGK: P, M, K, F(subsection), T, C, U, Z, L, N, D, R, ZR 2) XGI/XGR: I, Q, M, L, K, U, R, W, F(subsection) Refer to the list of XGT CPU memory device in appendix for available range of each memory area.
Save area Word size	Size (Word)	The data size of received block in word unit

[Table 6.4.3] High-speed link settings

(15) Downloading High-speed link parameters.

After High-speed link parameters setting is complete, select [Online] - [Write (standard settings, HS link, P2P)] on XG5000, check applicable High-speed link and then click [OK].

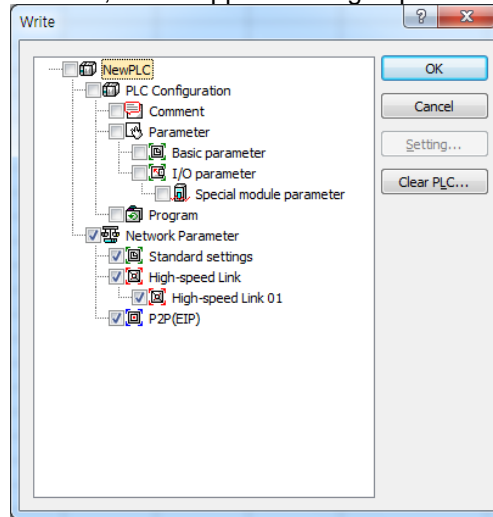

[Fig. 6.4.7] Write Parameters Screen

(16) High-speed link parameters enable

Select [Online] – [Communication module setting] - [Enable Link] on XG5000, check applicable High-speed link and click [Write]. If High-speed link enabled, HS LED will be turned ON on the module’s LED display to start High-speed link.

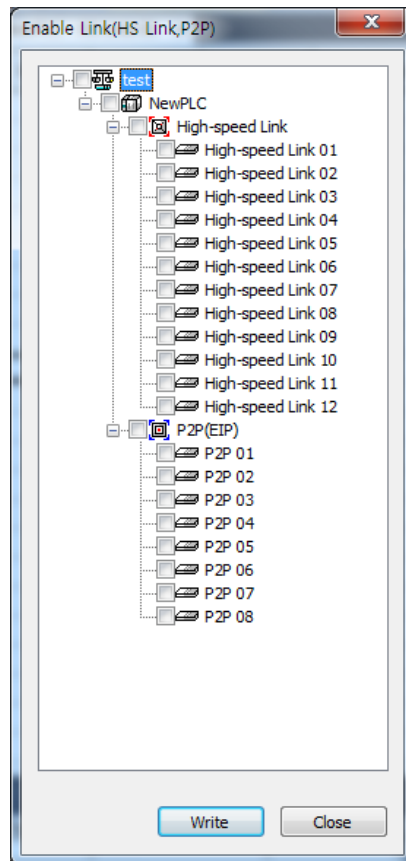

[Fig. 6.4.8] Link Enable Screen

## 6.5 High-speed Link Information

### 6.5.1 High-speed Link Flags

When High-speed link service is used to exchange data between communication modules of two or more stations, it provides a checking method of High-speed link service status for the user through High-speed link information so to confirm reliability of the data read from the destination station via the High-speed link. In other words, the communication module synthesizes the data received up to that time at intervals of a specific time and lets the user know if High-speed link is operated as in parameters specified by the user through High-speed link information where the whole information of Run-link(\_HSxRLINK) and Link-trouble(\_HSxLTRBL) to provide the whole information of the communication, and the individual information of \_HSxSTATE, \_HSxTRX, \_HSxMOD and \_HSxERR to provide communication status for registered items in the parameters are contained. The user can use the information in keyword format when programming, and also monitor the High-speed link status using the monitor function of the High-speed link information. Prior to its application, the user is requested to check the reliability of the communication data through High-speed link information of Run-link and Link-trouble when operating several PLCs with High-speed link service. [Table 6.5.1] shows the functions and definition of the High-speed link information.

Classification	Run-link	Link-trouble	Tx/Rx status	Operation Mode	Error	HS link status
Information type	Whole information	Whole information	Individual information	Individual information	Individual information	Individual information
Keyword name (x=HS link No.)	_HSxRLINK	_HSxLTRBL	_HSxTRX[n] (n=0~127)	_HSxMOD[n] (n=0~127)	_HSxERR[n] (n=0~127)	_HSxSTATE[n] (n=0~127)
Data type	Bit	Bit	Bit-Array	Bit-Array	Bit-Array	Bit-Array
Monitor	Available	Available	Available	Available	Available	Available
Program	Available	Available	Available	Available	Available	Available

[Table 6.5.1] The definition of High-speed link information.

Select [Variable/Comment] on the XG5000 project window to display [Fig. 6.5.1] as shown below. From this window drag the device to be monitored on to the variable monitor window.

	PLC	Program	Variable/Device	Value	Type	Device/Variable	Comment
1	NewPLC	<GLOBAL>	%LX0	10	BOOL	_HS1_RLINK	All stations are OK in HS link 1
2	NewPLC	<GLOBAL>	%LX1	10	BOOL	_HS1_LTRBL	Trouble after _HS 1 RLINK on
3	NewPLC	<GLOBAL>	%LX32	10	BOOL	_HS1_STATE000	Total states of HS link 1-block 000
4	NewPLC	<GLOBAL>	%LX160	10	BOOL	_HS1_TRX000	Normal communication with HS link 1-block 000
5	NewPLC	<GLOBAL>	%LX288	10	BOOL	_HS1_SETBLOCK000	Setting of HS link 1-block 000
6	NewPLC	<GLOBAL>	%LX416	10	BOOL	_HS2_RLINK	All stations are OK in HS link 2
7	NewPLC	<GLOBAL>	%LX544	10	BOOL	_HS2_MOD032	Operation mode of HS link 2-block 032
8							

[Fig. 6.5.1] Variable monitor window

### (1) Run-link (\_HSxRLINK)

As the whole information it shows if High-speed link is normally executed through the user defined parameters, whose status will be kept 'On' if once 'On' until Link Enable is 'Off', and also will be 'On' under the conditions specified below.

- A) If Link Enable is 'On'.
- B) If all the register list settings of parameters are specified normally.
- C) If all the data applicable to the parameters register list is transmitted and received as specified in the period.
- D) If the status of all the destination stations specified in the parameters is Run and with no error at the same time.

### (2) Link-trouble (\_HSxLTRBL where x is HS link No.(1~12))

As the whole information it shows if High-speed link is normally executed through the user defined parameters, which will be turned 'On' if condition to be turned 'On' the Run-link flag is violated when Run-link is On, and will be turned Off if the condition is recovered.

### (3) Tx/Rx status (\_HSxTRX[0..127] where x is HS link No.(1~12))

As individual information it shows the operation status of High-speed link parameters on the register list up to 128 registered items' Tx/Rx information. If the Tx/Rx operation of the registered items is agreeable to the Tx/Rx period, the applicable bit will be turned On, and if not, it will be turned Off.

(4) Operation mode (`_HSxMODE[0..127]` where x is High-speed link No.(1~12))

As individual information it shows the operation status of High-speed link parameters on the register list up to 128 registered items' operation mode information just like the max. register number. If the station specified in the register item is in Run mode, the applicable bit will be turned On, and if in Stop/Pause/Debug mode, it will be turned Off.

(5) Error (`_HSxERR[0..127]` where x is High-speed link No.(1~12))

As individual information it shows the operation status of High-speed link parameters on the register list up to 128 registered items' error information just like the max. register number. The error displays the general status of the PLC which fails to execute the user program. If the destination station PLC is normal, it will be turned Off, and if abnormal, it will be turned On.

(6) HS link status (`_HSxSTATE[0..127]` where x is High-speed link No.(1~12))

As individual information it shows the operation status of High-speed link parameters on the register list up to 127 registered items' High-speed link status just like the max. register number, which synthesizes the information of the individual items to display the general information of the registered items. In other words, if the applicable list's Tx/Rx status is normal with the operation mode of Run and with no error, it will be turned On, and if the conditions above are violated, it will be turned Off.

### 6.5.2 Monitor of High-speed link information

High-speed link information can be checked through the variable monitor on the monitor menu when XG5000 is online state, or through the XG5000 diagnosis service.

(1) Variable monitor

Variable monitor is a function to register the variables to be monitored and monitor the selected variables. Select [View] - [Variable Monitor Window] to display the variable registration screen as shown in [Fig. 6.5.1], and there select [Flag] directly to select and register High-speed link information flag one by one on the screen of the variable flags list. At this time, since `_HSxSTATE[n]`, `_HSxERR[n]`, `_HSxMOD[n]` and `_HSxTRX[n]` are the flags of array type, the user needs directly to select the array numbers which stand for the register numbers inside the parameters.

(2) High-speed link monitor from the XG5000 diagnosis services

- A) It will be available through the menu [Connect] -> [Online] -> [Communication module setting] -> [System Diagnosis] on XG5000.

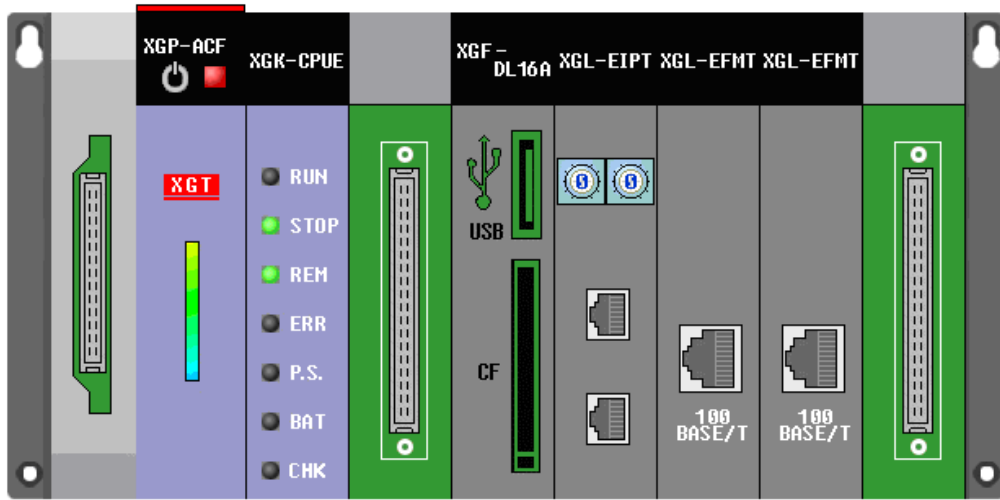

[Fig. 6.5.2] System Diagnosis

(3) With the mouse cursor placed on the applicable module, click the right button of the mouse and select 'Status for Respective Services' to open [Fig. 6.5.3] screen as shown below.

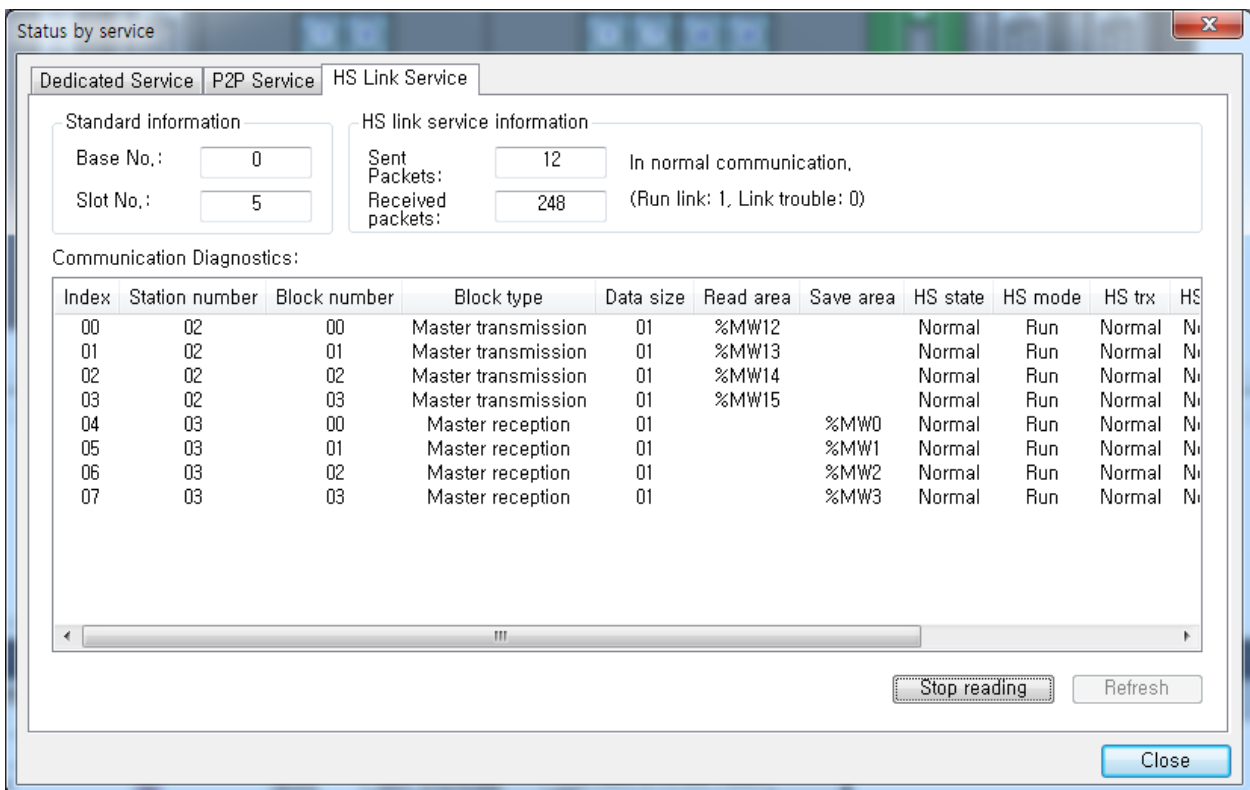

[Fig. 6.5.3] XG5000 Diagnosis Services (status for respective services)

## 6.6 High Speed Link at Redundant system

### 6.6.1 In case of redundant network

When configuration redundant NET, station number and IP address of A-Side and B-side can be set without restriction. Namely, they can use same station number (IP address) or different station number because their networks operate respectively. There is no restriction.

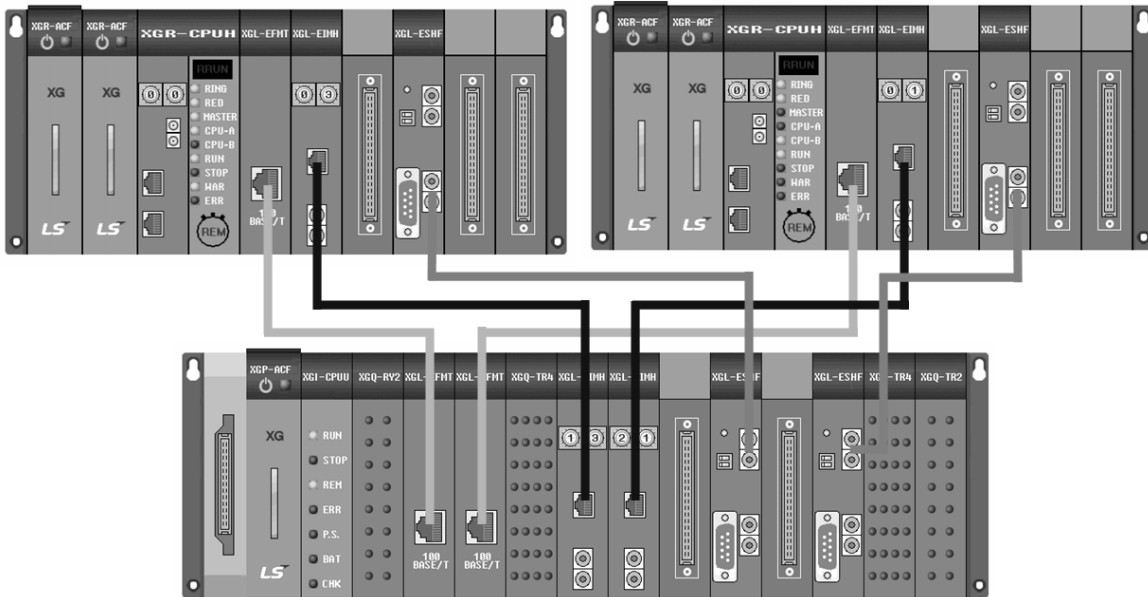

[Fig 6.6.1] Redundant network configuration

#### (1) In case XGR is transmission mode and XGK(I) is reception mode

##### 1) Publication of sequence number

When sending the data at XGR, The first 1 word should publish the sequence number (SEQ\_NO), this sequence number increases by 1 every scan.

##### 2) User data

The data to send actually is set other parts except the first 1 word. Since communication module of MASTER and STANDBY always execute same service at XGR system, the reception side should determine which data to get. And when there is error in one side, the reception part needs program to get the data of another side and not to get the data of one in error. The reception part can receive the correct data by receiving the data of updated sequence number.

##### 3) Input data setting of reception side

Reception part take the data of updated sequence number as input data regardless of A-Side or B-Side and memories the sequence number. Generally, scan time of Standby communication module is slower than that of Master communication module with amount of 1 scan. So reception part takes the data of Master side as input data and memorizes the sequence number at that time. Though there is data from Standby side, reception part ignores that data considering not updated sequence number.

If communication of one side is not available because of line error, the data having the not updated sequence number is not taken as input. So the user can take advantage of redundant system.

4) Function Block for High Speed Link

At XGR and XGI, there is function block to deal with the reception data. And at XGK, there is no function block. So apply the program acting as Function Block. Refer to Ch6.7

5) TX/RX method by using sequence number is standard algorithm. If there is special pattern according to user application, the user can't use this.

**(2) In case XGK(I) is transmission mode and XGR is reception mode**

1) TRX setting

Make the two modules of XGK(I) send same data by same setting. At this time, sequence number is not necessary. Take the data entering to the Master as input data and considering the network error, use the STATE FLAG as condition to take the input data. If STATE FLAG is OFF, copy the data of Standby to Master by SYNC instruction and take it as input data

**Note**

(1) For block setting, A-Side and B-Side is used in same manner. So station number of TX is different, take the double of block.

### 6.6.2 In case of single network

In case of single network, A-Side and B-Side are in the same network so station number and IP address should be different.

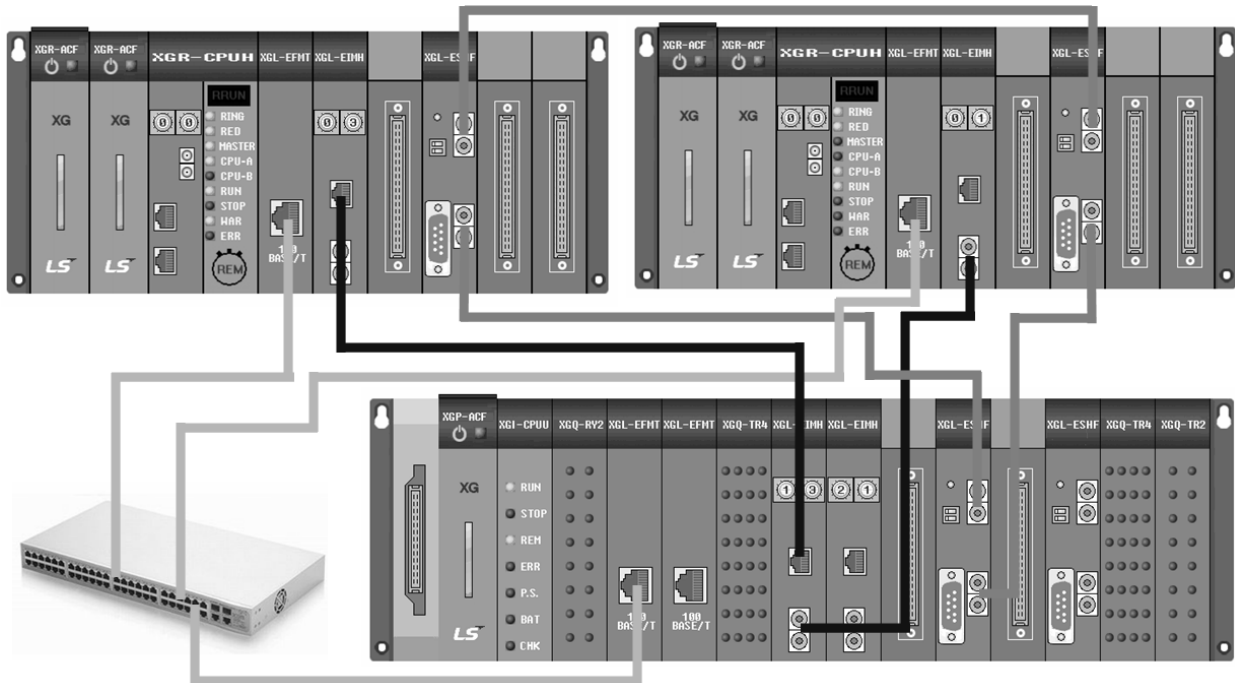

[Fig 6.6.2] Single network configuration

(1) In case XGR is transmission mode and XGK(I) is reception mode

1) Data TRX

In case of transmission, since station to receive is only one, communication setting is same with that of XGK(I)-XGK(I). In the reception side, when FLAG is ON, receive the data of A-Side and when FLAG is OFF, receive the data of B-Side

(2) In case XGK(I) is transmission mode and XGR is reception mode

1) Data TRX

Make the XGK(I) send the same data to two communication module. In the reception side, take the data entering to Master as input data and use STATE FLAG as input condition of SYNC instruction to copy the Standby data to Master

**6.7 High Speed Link Setting Program Example**

**6.7.1 In case of redundant system**

- (1) In case XGR is transmission mode and XGK(l) is reception mode
  - 1) Communication setting (XGR transmission side)
    - a) Stand parameter setting (When One IP Solution is used and same HS link station number is applied)

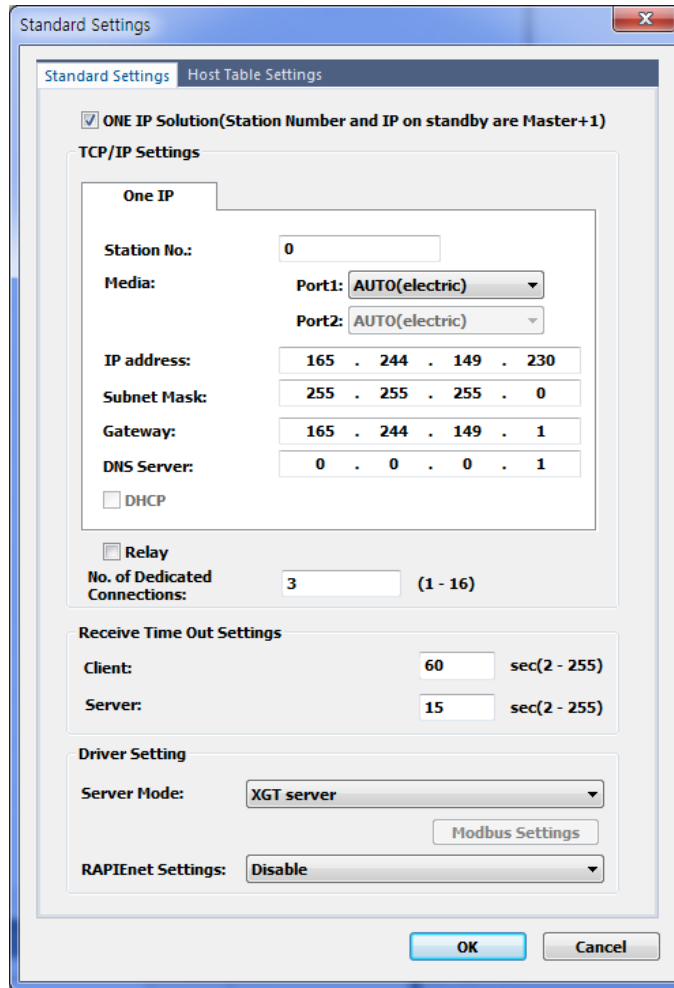

[Fig 6.7.1] Communication redundant standard setting

b) HS link block setting (In case sequence number is saved in Block 0)

Index	Station type	Mode	Station number	Block number	Read area	Read area Word size	Save area	Save area Word size
0	MASTER	Send	A-side:0, B-side:0	0	%MW0	1		
1	MASTER	Send	A-side:0, B-side:0	1	%MW100	2		

[Fig 6.7.2] HS link block setting including sequence

c) HS link block setting (In case of setting sequence number (First Word) and user data in Block 0)

Index	Station type	Mode	Station number	Block number	Read area	Read area Word size	Save area	Save area Word size
0	MASTER	Send	A-side:0, B-side:0	0	%MW100	3		

[Fig 6.7.3] HS link block setting not including sequence

- 2) Ladder program (XGR reception side)
  - a) Increase the sequence number in the first Block and set the data to send in the second Block

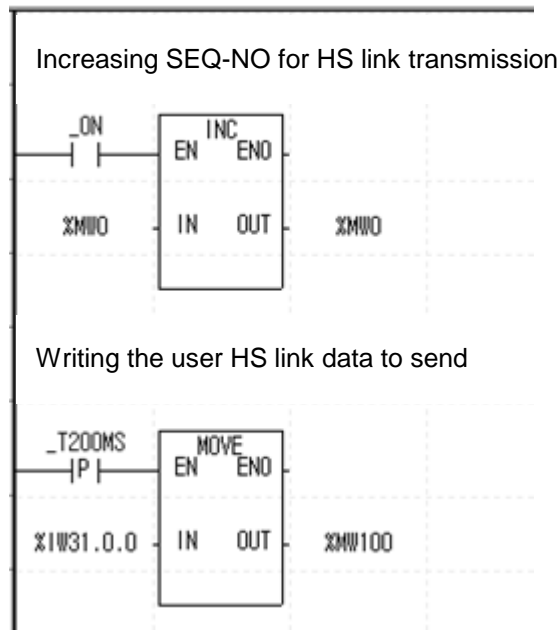

[Fig 6.7.4] sequence program setting screen

- 3) Communication setting (XGK(l) reception part)
  - a) Standard parameter setting

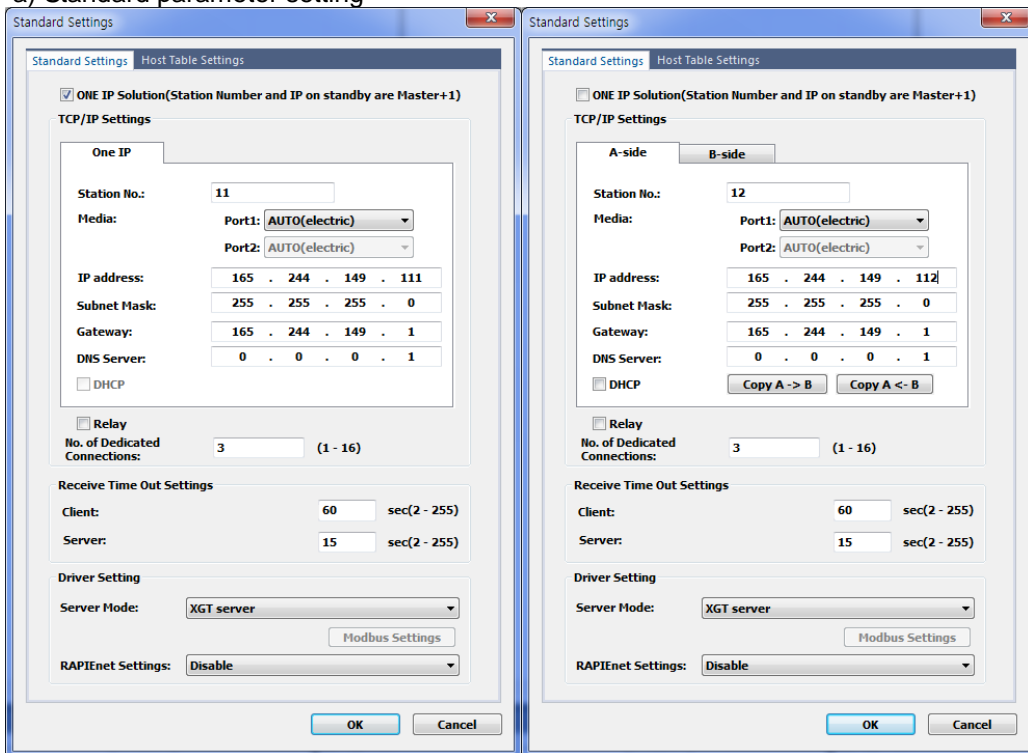

Standard setting of Comm. Module connected to A-Side

Standard setting of Comm. Module connected to B-Side

[Fig 6.7.5] Reception communication standard setting

## Chapter 6 High-speed Link Service

### b) HS link block setting (Comm. module connected to XGR A-Side)

Index	Station type	Mode	Station number	Block number	Read area	Read area Word size	Save area	Save area Word size
0	MASTER	Receive	0	0			%MW10	1
1	MASTER	Receive	0	1			%MW110	2

[Fig 6.7.6] HS link parameter setting including sequence reception

The user can set SEQ-NO and user data in one block like the figure below

Index	Station type	Mode	Station number	Block number	Read area	Read area Word size	Save area	Save area Word size
0	MASTER	Receive	0	0			%MW109	3

[Fig 6.7.7] HS link parameter setting not including sequence reception

### c) HS link block setting ( Comm. module connected to XGR B-Side)

Index	Station type	Mode	Station number	Block number	Read area	Read area Word size	Save area	Save area Word size
0	MASTER	Receive	0	0			%MW20	1
1	MASTER	Receive	0	1			%MW120	2

[Fig 6.7.8] HS link parameter setting including sequence reception

The user can set SEQ-NO and user data in one block like the figure below

Index	Station type	Mode	Station number	Block number	Read area	Read area Word size	Save area	Save area Word size
0	MASTER	Receive	0	0			%MW119	3

[Fig 6.7.9] HS link parameter setting not including sequence reception

## 4) Ladder program (XGK(I) reception side)

### a) Setting the input data by using HS\_FB Function Block

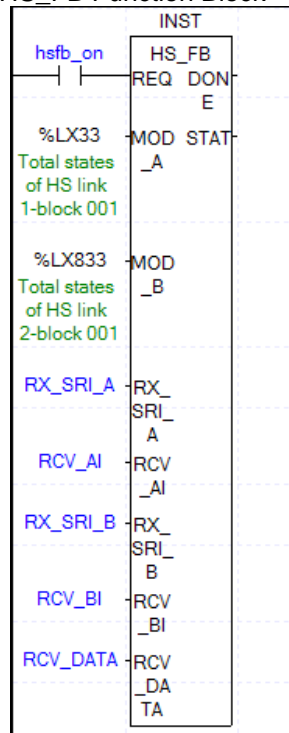

[Fig 6.7.10] Function Block for redundant HS link reception data

Classification	Contents
MOD_A	STATE FLAG about HS link input block of A-Side
MOD_B	STATE FLAG about HS link input block of B-Side
RX_SRI_A	SEQ No. of A-Side (Device setting (Word) of HS link first input block)
RCV_A1	Reception data of A-Side (flexible Array)
RX_SRI_B	SEQ No. of B-Side (Device setting (Word) of HS link first input block)
RCV_B1	Reception data of B-Side (flexible Array)
RCV_DATA	Input data considering SEQ No. of A-Side, SEQ No. of B-Side and STATE

b) HS link reception ladder program at XGK

Since Function block is not provided at XGK, refer to the following ladder. Input SEQ-No. of A-Side/B-side at RX\_SRI\_A/B and input device of input data at RCV\_A1/B1. MOV instruction is set as size of 10 at the bottom item. Considering size of input, fix them. For other items, refer to Function Block used XGR(I) of same name.

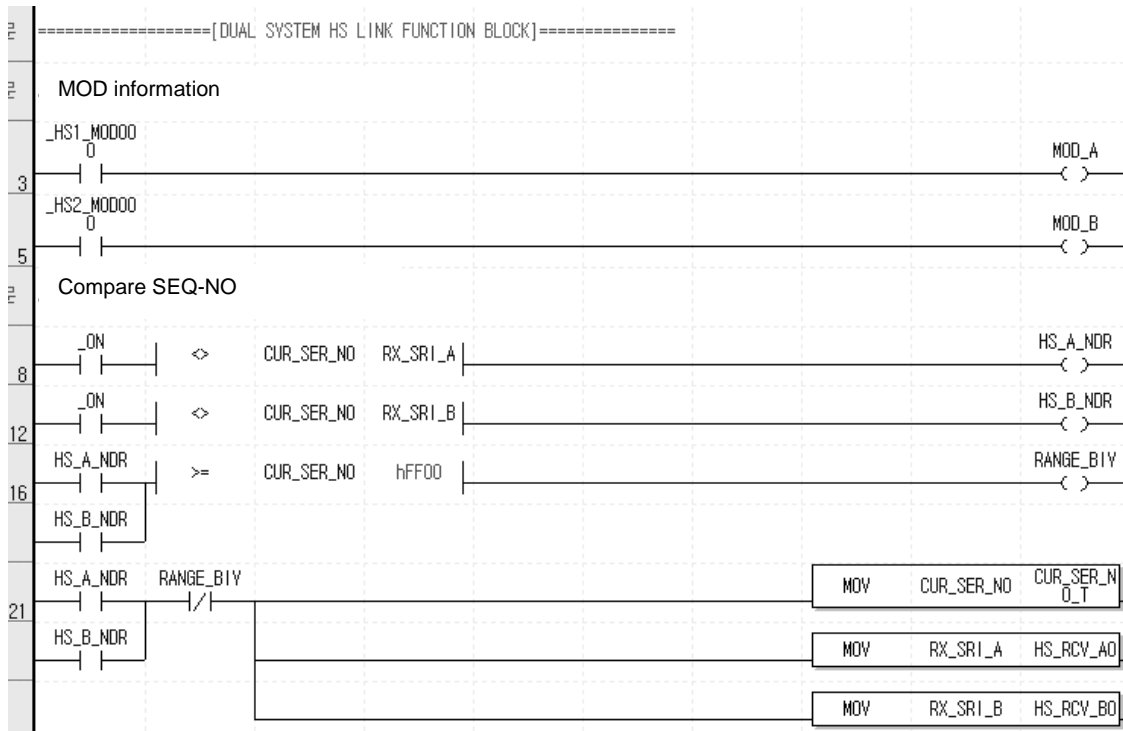

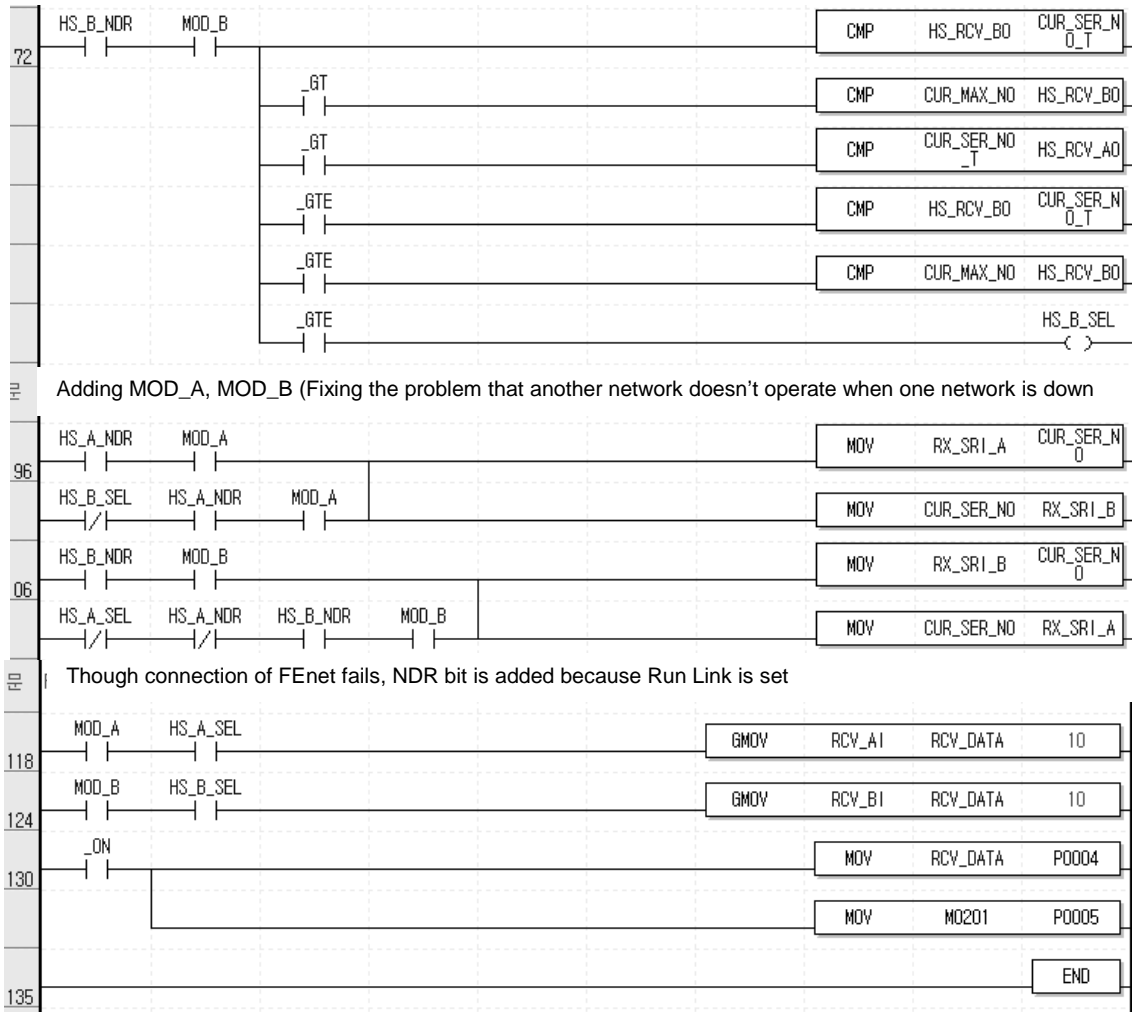

(2) In case XGK(I) is transmission mode and XGR is reception mode

1) Communication setting(XGK(I) transmission part)

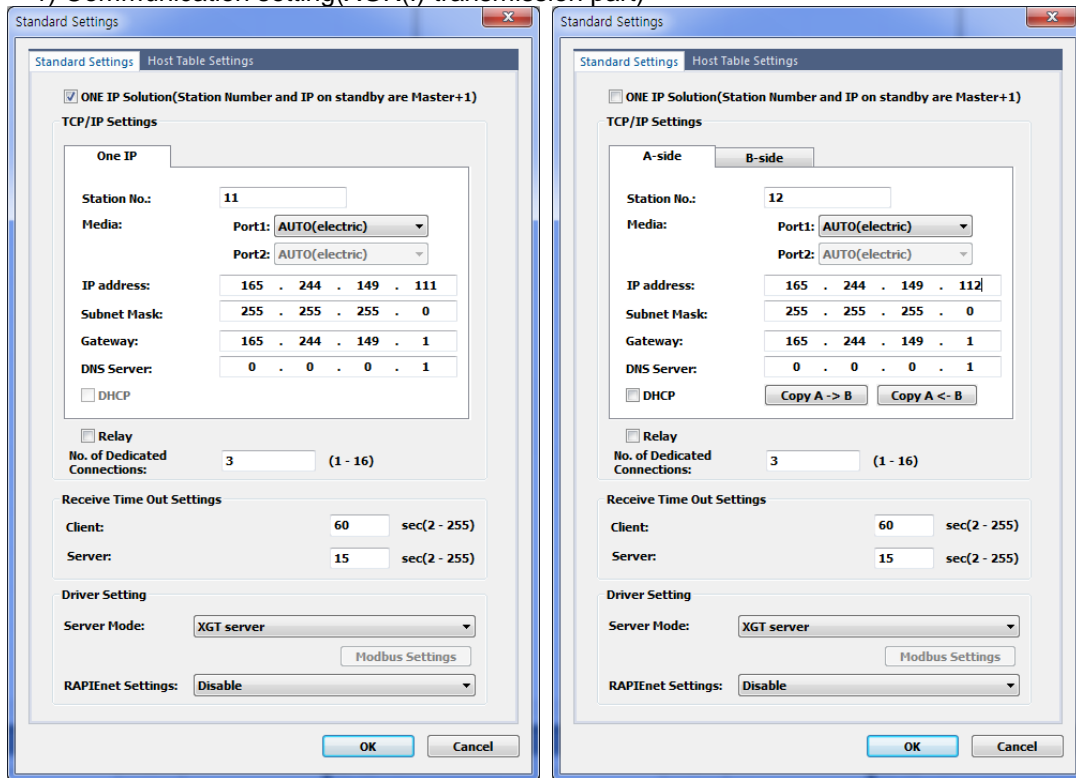

Standard setting connected to A-Side      Standard setting connected to A-Side  
 [Fig 6.7.11] Single standard setting

a) HS link block setting (Comm. module connected to XGR A-Side)

Index	Station type	Mode	Station number	Block number	Read area	Read area Word size	Save area	Save area Word size
0	MASTER	Send	11	0	%Mw100	200		
1	MASTER	Send	11	1	%Mw100	200		

[Fig 6.7.12] A-SIDE High Speed Link parameter setting

b) HS link block setting (Comm. module connected to XGR B-Side)

Index	Station type	Mode	Station number	Block number	Read area	Read area Word size	Save area	Save area Word size
0	MASTER	Send	12	0	%Mw100	200		
1	MASTER	Send	12	1	%Mw100	200		

[Fig 6.7.13] B-SIDE High Speed Link parameter setting

2) Ladder program (XGK(I) reception side)

High speed link reception data setting

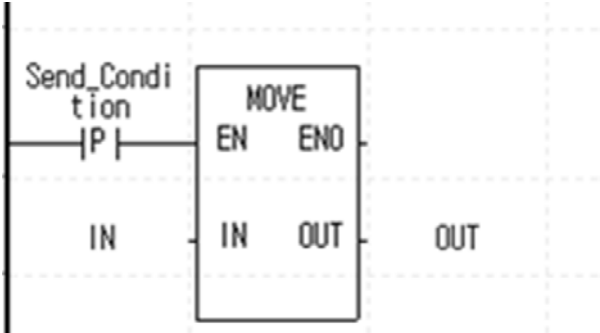

[Fig 6.7.14] Ladder program to send data

3) Comm. setting (XGR reception side)  
 a) Standard parameter setting

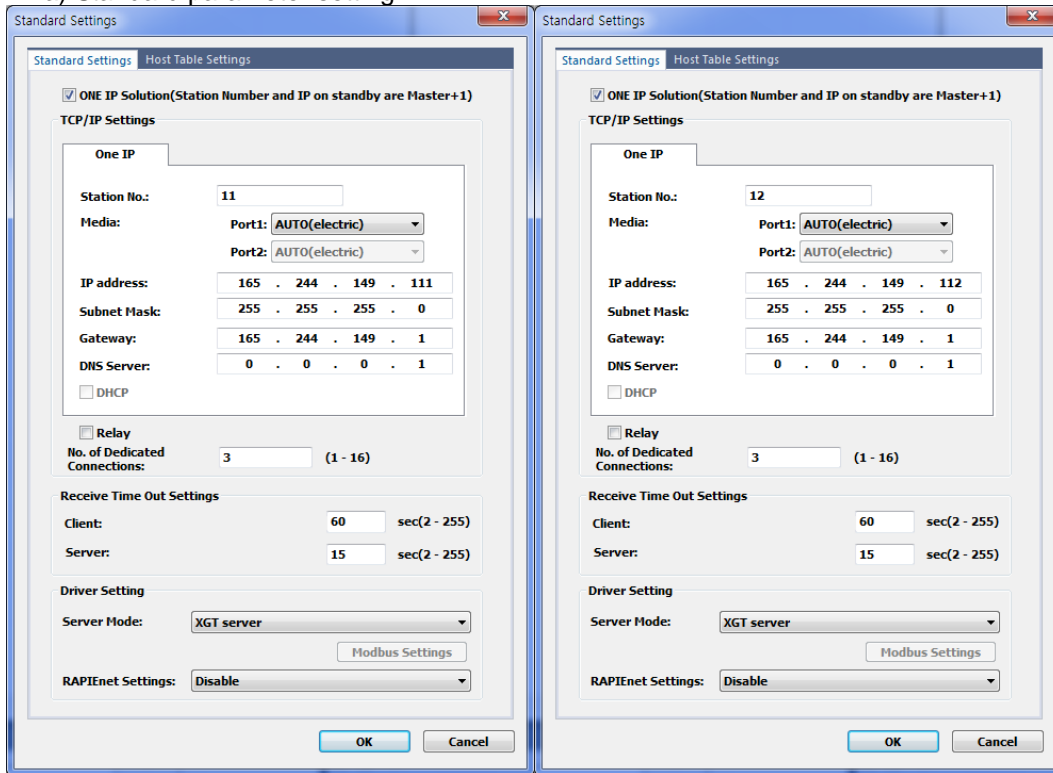

[Fig 6.7.15] redundant reception side standard setting

b) Block setting

Index	Station type	Mode	Station number	Block number	Read area	Read area Word size	Save area	Save area Word size
0	MASTER	Receive	11	0			%MW100	200
1	MASTER	Receive	11	1			%MW500	200
2	MASTER	Receive	12	0			%MW100	200
3	MASTER	Receive	12	1			%MW500	200

[Fig 6.7.16] Redundant HS link reception parameter setting

4) Ladder program (XGR reception side)

In case network is normal, the user can take data of Master side but in case network is not normal, the user copy the data of Standby to Master and take it as input data by using STATE FLAG and SYNC instruction. At this time, user should set all reception block of both A/B-Side so use STATE FLAG not \_HSx\_LTRBL as a condition to check network status

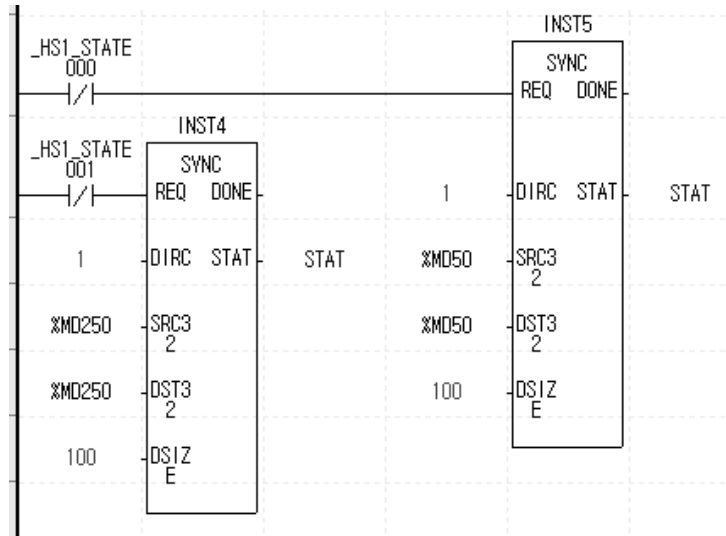

[Fig 6.7.17] Ladder program through SYNC instruction

## 6.7.2 In case of single network

- (1) In case XGR is transmission mode and XGK(I) is reception mode
- 1) Communication setting (XGR reception side)

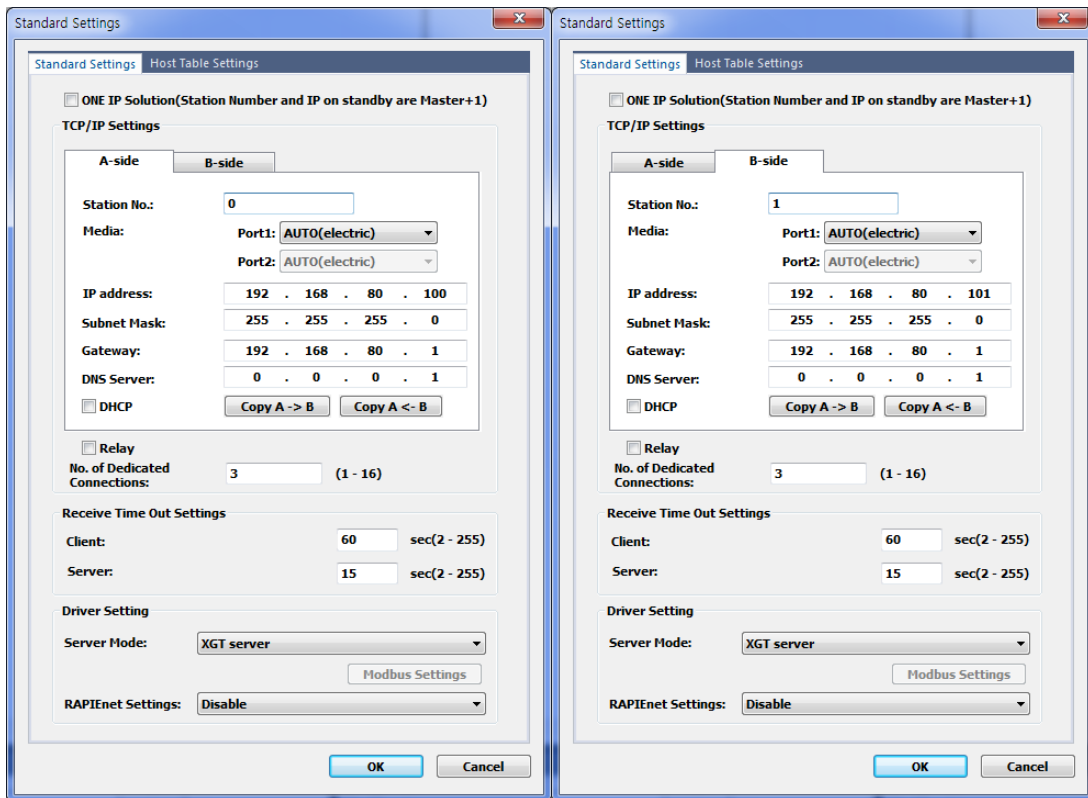

[Fig 6.7.18] redundant standard setting

Index	Station type	Mode	Station number	Block number	Read area	Read area Word size	Save area	Save area Word size
0	MASTER	Send	A-side:0, B-side:1	0	%MW0	1		
1	MASTER	Send	A-side:0, B-side:1	1	%MW100	2		

[Fig 6.7.19] Redundant HS link parameter setting including SEQ-No.

2) Ladder program (XGR reception side)

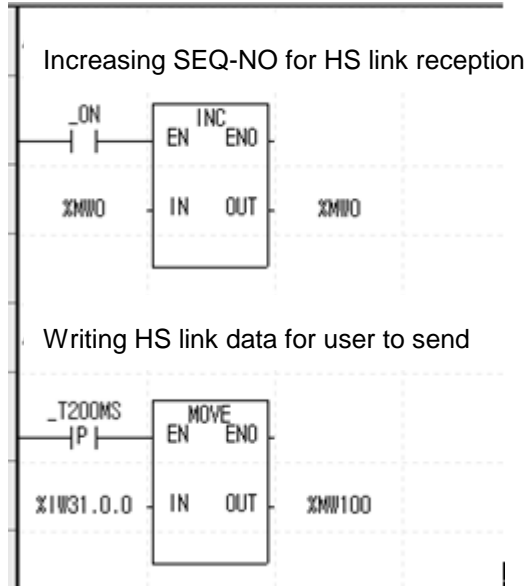

[Fig 6.7.20] sequence ladder program

3) Communication setting(XGK(I) reception side)

Index	Station type	Mode	Station number	Block number	Read area	Read area Word size	Save area	Save area Word size
0	MASTER	Receive	0	0			%MW10	1
1	MASTER	Receive	0	1			%MW100	2
2	MASTER	Receive	1	0			%MW20	1
3	MASTER	Receive	1	1			%MW120	2

[Fig 6.7.21] Reception side Hs link parameter setting including SEQ-No.

4) Ladder program (XGK(I) reception side)

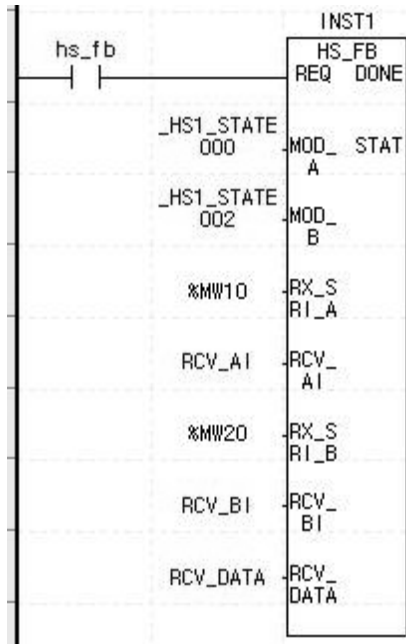

[Fig 6.7.22] HS link reception FB setting

(2) In case XGK(I) is transmission mode and XGR is reception mode  
 1) Communication setting (XGK(I) reception side)

Index	Station type	Mode	Station number	Block number	Read area	Read area Word size	Save area	Save area Word size
0	MASTER	Send	11	0	%Mw0	200		
1	MASTER	Send	11	1	%Mw1000	200		

[Fig 6.7.23] HS link parameter setting

2) Ladder program (XGK(I) transmission side)

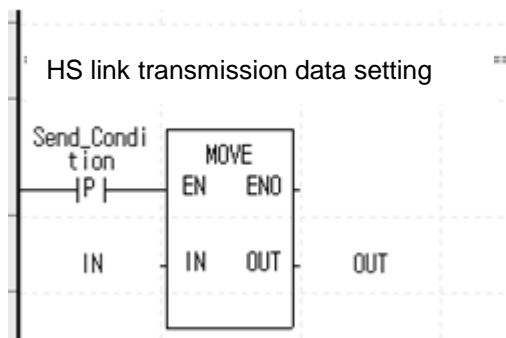

[Fig 6.7.24] Ladder program setting screen

3) Communication setting (XGR reception side)

Index	Station type	Mode	Station number	Block number	Read area	Read area Word size	Save area	Save area Word size
0	MASTER	Receive	11	0			%Mw0	200
1	MASTER	Receive	11	1			%Mw1000	200

[Fig 6.7.25] Redundant reception Hs link parameter setting

4) Ladder program (XGR reception side)

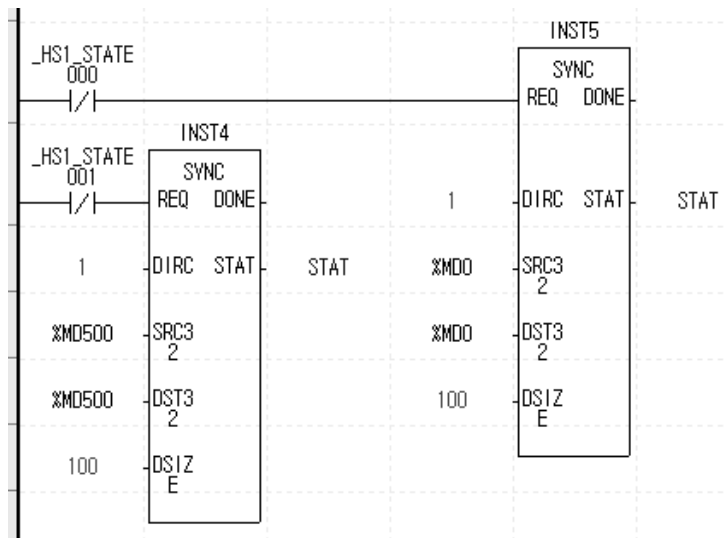

[Fig 6.7.26] Ladder program through SYNC instruction

## Chapter 7 P2P Service

### 7.1 Introduction

#### 7.1.1 Introduction to P2P service

P2P service executes Master operation of the communication module as realized with parameters setting which was with function blocks (instruction). 8 P2P instructions available in FEnet I/F module are Read, Write, Write\_NC, Send, Send\_NC, Receive, ESend and EReceive.

P2P service's registration and edit is executed in XG5000 where up to 8 P2P parameters can be setup. Respective P2P parameter is composed of up to 64 P2P blocks.

[Fig. 7.1.1] shows an example of P2P parameters setting window in XG5000.

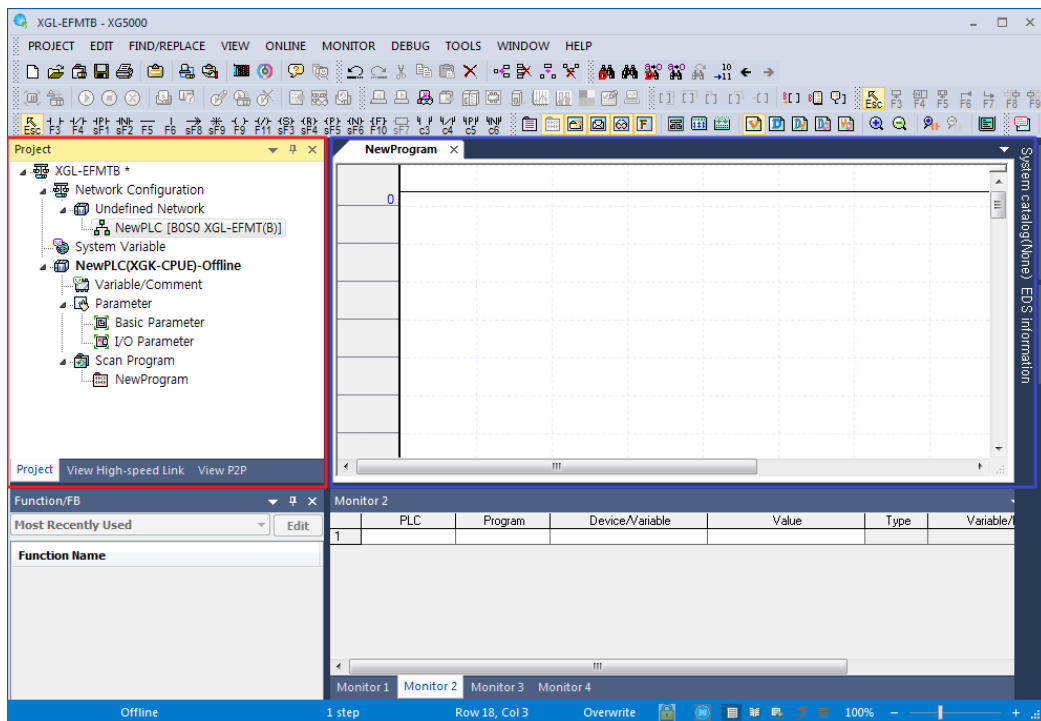

[Fig. 7.1.1] Setting window of XG5000's P2P parameters

#### (1) P2P parameters registration window

- Up to 8 P2P parameters can be setup.
- Multiple P2P parameters can be setup for an identical communication module.
  - However, Enable is available only for 1 parameter among the multiple P2P parameters for the identical communication module.
- Respective P2P parameter is composed of P2P channel, P2P block, user defined frame and e-mail.

#### (2) P2P edit window

- Up to 64 P2P blocks can be registered and edited.
- Separate frame registration is available for respective drivers.

## 7.1.2 Configuration of P2P parameters

In order to use P2P service the user needs to execute setting for the operation desired on the P2P parameters window. Specify type, base and slot as desired on the P2P screen to display P2P parameters setting screen composed of 4 kinds of information as shown in the figure below;

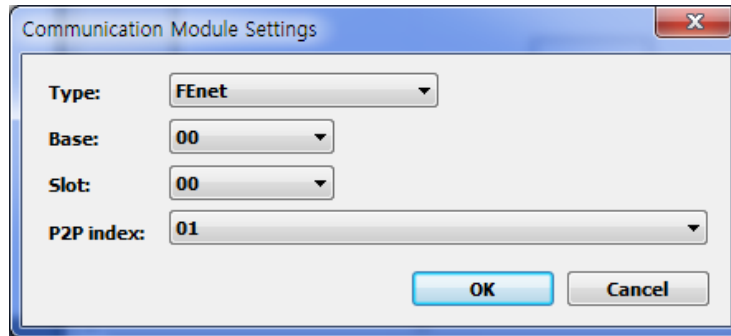

[Fig. 7.1.2] P2P parameters module setting

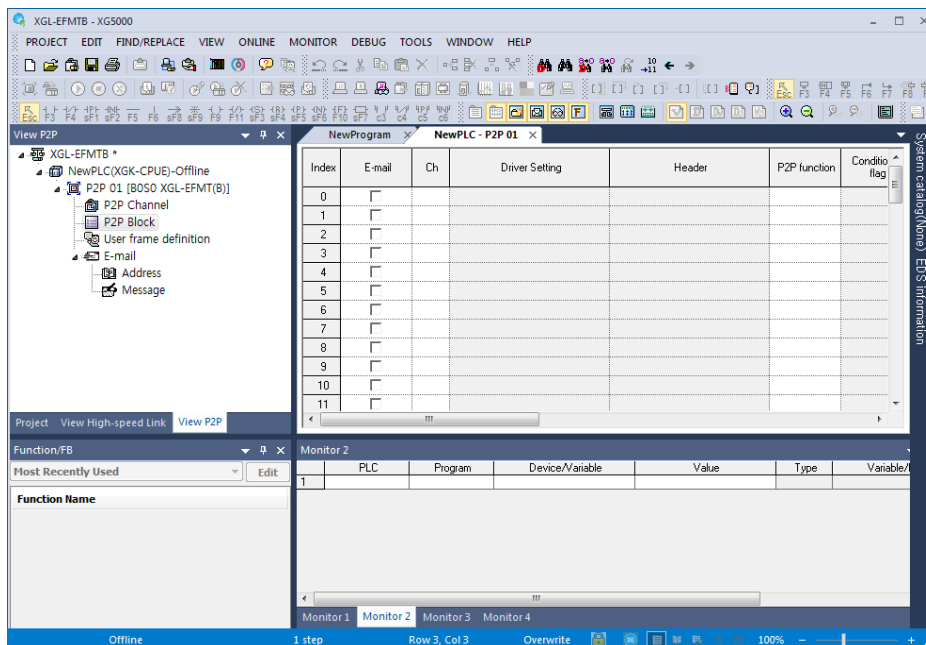

[Fig. 7.1.3] Setting and registration screen of P2P parameters

- (1) P2P channel
  - Logical channel of P2P Service (IP, PORT, dedicated driver) to be executed can be setup.
  - User defined frame, XGT client and MODBUS TCP client setting available.
  - Communication device setting available which uses other protocol than XGT/MODBUS TCP.
- (2) P2P block
  - 64 P2P blocks setting separately operated.
- (3) Define user frame
  - Registration of user defined frames.
- (4) E-mail
  - Frame registration to transmit and receive e-mail frames.

## 7.2 Type of P2P Service

### 7.2.1 Type of P2P Instructions

(1) P2P instructions

6 instructions are available for programming P2P communication service, and each instruction will be used with different purpose according to respective service methods as described in the table below, for reference.

Classification	Instruction	Purpose
XGT Client	Read	Reads the area specified by destination station.
	Write	Transmits native station's area data to destination station.
	Write_NC	Transmits native station's area data to destination station. (No confirmation)
User defined frame	Send	Transmits native station's area data to destination station.
	Send_NC	Transmits native station's area data to destination station. (No confirmation)
	Receive	Saves the data received from destination station.
Modbus Client	Read	Reads the area specified by destination station.
	Write	Transmits native station's area data to destination station.
E-mail	ESend	Transmits a message if an event occurs.
	EReceive	Receives a message if an event occurs.

[Table 7.2.1] Type of P2P instructions

#### Note

1) Difference between Write (Send) and Write\_NC (Send\_NC)

In general P2P communication, it sends the request data at start condition, and then it sends the request data again at next start condition after receiving the response. If you use "Write\_NC (Send\_NC)" instruction, it sends data at next start condition without receiving response. Because of that, faster communication is available. The Read (Receive) service that requires response does not support this option.

※ TX data for one start condition should be less than 3KB. If not, communication error may occur

2) For Write\_NC, Send\_NC instructions, the following version is needed.

Item	Version
XG5000	V3.61 or above
XGR CPU	V1.91 or above

### 7.2.2 Type of P2P Service

(1) XGT Enet Client/XGT Cnet Client (OS V6.0 or above)

XGT Client service is used to communicate between XGT FEnet I/F modules. Through its own protocol built-in without additionally defined frame, the user can specify communication settings simply with basic settings of channel, data type (BIT, BYTE, WORD, etc.) and memory area. Use port No.2004 for TCP, and port No.2005 for UDP protocol.

(2) User defined frame

This service is used to communicate between XGT FEnet I/F module and other company's Ethernet devices. Since the communication protocol of devices based on Ethernet is differently defined by different makers, all kinds of communication drivers can not be provided for respective device. Thus, the user is allowed to edit appropriately to the characteristics of the applicable communication module, for which the user needs to specify User Defined Frame and then define the Ethernet user's frames with basic structure composed of Header, Body and Tail. Up to 16 channels can be specified.

(3) Modbus Client / Modbus RTU (OS v6.0 or above) / Modbus ASCII(V6.0 or above) client

XGT FEnet supports Modbus protocol widely used as of now as well as User Defined protocol.

(4) RAPIEnet Client (OS v6.0 or above)

RAPIEnet client service can be used if RAPIEnet is enabled in basic parameter.

## 7.3 How to Set P2P Service

### 7.3.1 Ethernet (server) driver

(1) Driver setting

Ethernet (server) driver stands for the protocol built-in XGT FEnet module. 2 kinds of server protocol, XGT server and MODBUS TCP/IP, are built-in XGT FEnet I/F module. Ethernet(server) driver can be used to communicate between Ethernet devices with XGT or MODBUS TCP/IP protocol. The destination station in Ethernet communication system is generally MMI (or HMI), where communication is available with the correspondent device only through parameters setting without additional communication programming by user. [Fig. 7.3.1] shows the typical example of communication with MMI PC with Ethernet driver used, where FEnet responds if MMI PC requests to read or write data.

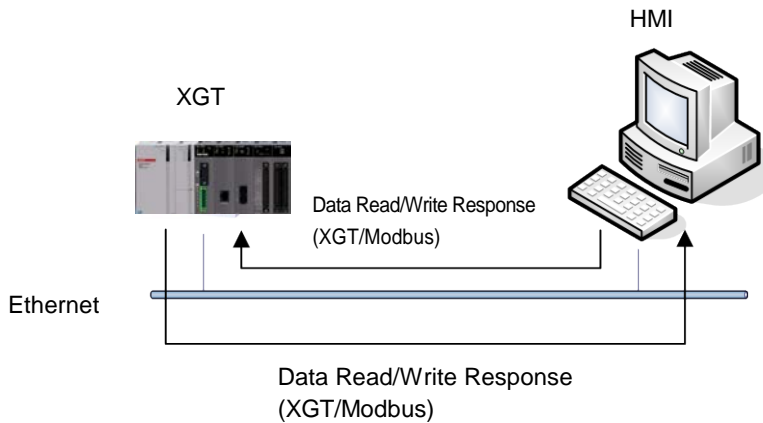

[Fig. 7.3.1] Example of Ethernet (server) driver application

(2) Type of Ethernet (server) drivers

Driver types available are as specified below;

Type	Description
XGT Enet server	XGT FEnet dedicated protocol by LSIS
XGT Cnet server (OS v6.0 or above)	XGT Cnet dedicated protocol by LSIS
Modbus TCP/IP server	Open type of protocol by Modicon
Modbus ASCII server (OS v6.0 or above)	Open type of protocol by Modicon
Modbus RTU server (OS v6.0 or above)	Open type of protocol by Modicon
RAPIEnet server (OS v6.0 or above)	RAPIEnet protocol by LSIS

[Table 7.3.1] Types of Ethernet (server) drivers

### Notes

- (1) The number of drivers is changeable according to specified Ethernet channel.  
Be careful! If Ethernet channel is specified, the number of drivers available will be decreased as many as specified.
- (2) Ethernet (server) driver supports 1:N communication, where accordingly, several master devices can take data through a specified port connected with.
- (3) Each port of server can be connected simultaneously up to 64.

7.3.2 P2P channel

Ethernet P2P channel is used when XGT FEnet I/F module executes the master function of communication with built-in XGT protocol or user defined protocol.

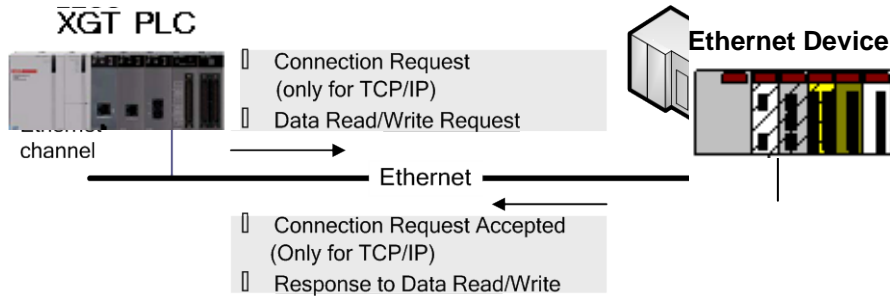

[Fig. 7.3.2] Application of P2P channel information

(1) Setting of P2P channel

FEnet I/F module can send and receive data using up to 16 channels, which is composed of IP address and port No. for two Ethernet devices. The number of channels available for P2P service is the maximum number of channels (16) minus the number of dedicated connections in the basic parameters (The number of P2P channels = 16 – the number of dedicated connections).

The maximum number of channels for modules with V6.0 or above is 32 regardless of the number of dedicated connections.

P2P communication is available with simple parameters setting to communicate with the device using XGT or Modbus TCP protocol for user’s convenience. And for the communication with other devices than described above, user can directly define frames as necessary.

In addition, messages and e-mail addresses can be registered to transmit and receive e-mail frames (ASCII supports).

However, it is not necessary to set the channel for e-mail communication.

If P2P channel is selected on the P2P setting window, the P2P channel setting window will appear as follows:

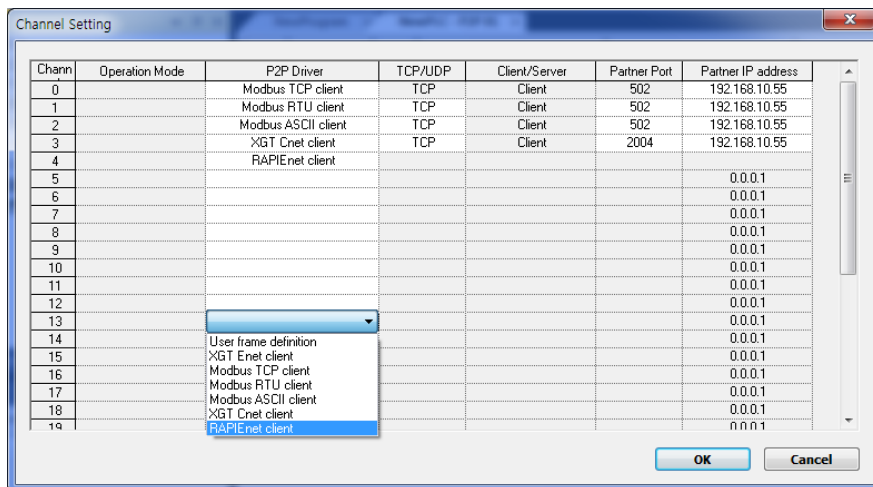

[Fig. 7.3.3] P2P channel settings window

If the desired port is selected, “P2P Channel Settings” window will appear for the user to define P2P driver type applicable for the port.

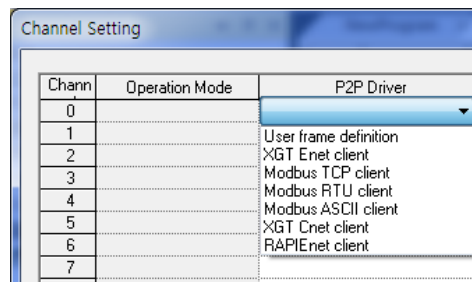

[Fig. 7.3.4] P2P driver client setting

Drivers and details available in XGT FEnet I/F are as follows;

Items		Details
P2P Driver	User frame definition	Used to send/receive data with user defined frame.
	XGT Enet client	XGT dedicated (Built-in) protocol (The user doesn't need to define the frame)
	XGT Cnet client (OS V6.0 or above)	XGT dedicated Cnet protocol. It communicates with LSIS Cnet I / F module connected with LTE modem.
	Modbus TCP client	MODBUS TCP protocol of MODICON
	Modbus ASCII Client (OS V6.0 or above)	MODBUS ASCII protocol of MODICON
	Modbus RTU Client (OS V6.0 or above)	MODBUS RTU protocol of MODICON
RAPIEnet Client (OS V6.0 or above)		Set RAPIEnet client. (However, RAPIEnet must be enabled in the basic parameter.)
TCP/UDP		Selects TCP or UDP. If user select Modbus TCP, this item is fixed as TCP
Client/Server		Select Client/Server. If user select the protocol as XGT/Modbus TCP, this item is fixed as Client
Partner Port		Inputs port number of partner. When defining protocol as User frame definition, user can define port number. H400~H1024 For XGT client, this item is fixed as 2004 and Modbus TCP client is fixed as 502.
Partner IP address		Input IP address of Partner device

[Table 7.3.2] Type of P2P driver clients

**Note****1) Partner IP address**

In case XGT is client, set the IP address of server device, If server uses DHCP for dynamic IP address, XGT can't communicate with server because IP address changes. So server have to use the fixed IP address.

If XGT or Modbus is selected as P2P driver type for the communication port, user defined frame can not be registered.

1) How to use Modbus driver

[Table 7.3.3] displays instructions and addresses of Modbus devices.

Code	Function code name	Modicon PLC data address	Remarks
01	Output Contact Status Read (Read Coil Status)	0XXXX(bit-output)	Bit Read
02	Input Contact Status Read (Read Input Status)	1XXXX(bit-input)	Bit Read
03	Output Register Read (Read Holding Registers)	4XXXX(word-output)	Word Read
04	Input Registers Read (Read Input Registers).	3XXXX(word-input)	Word Read
05	Output Contact 1 Bit Write (Force Single Coil)	0XXXX(bit-output)	Bit Write
06	Output Register 1 Word Write (Preset Single Register)	4XXXX(word-output)	Word Write
15	Output Contact Continuous Write (Force Multiple Coils)	0XXXX(bit-output)	Bit Write
16	Output Register Continuous Write (Preset Multiple Register)	4XXXX(word-output)	Word Write

[Table 7.3.3] Modbus TCP address MAP

### 7.3.3 P2P Block

If user select P2P block of relevant parameter, P2P parameter setting window will be displayed.

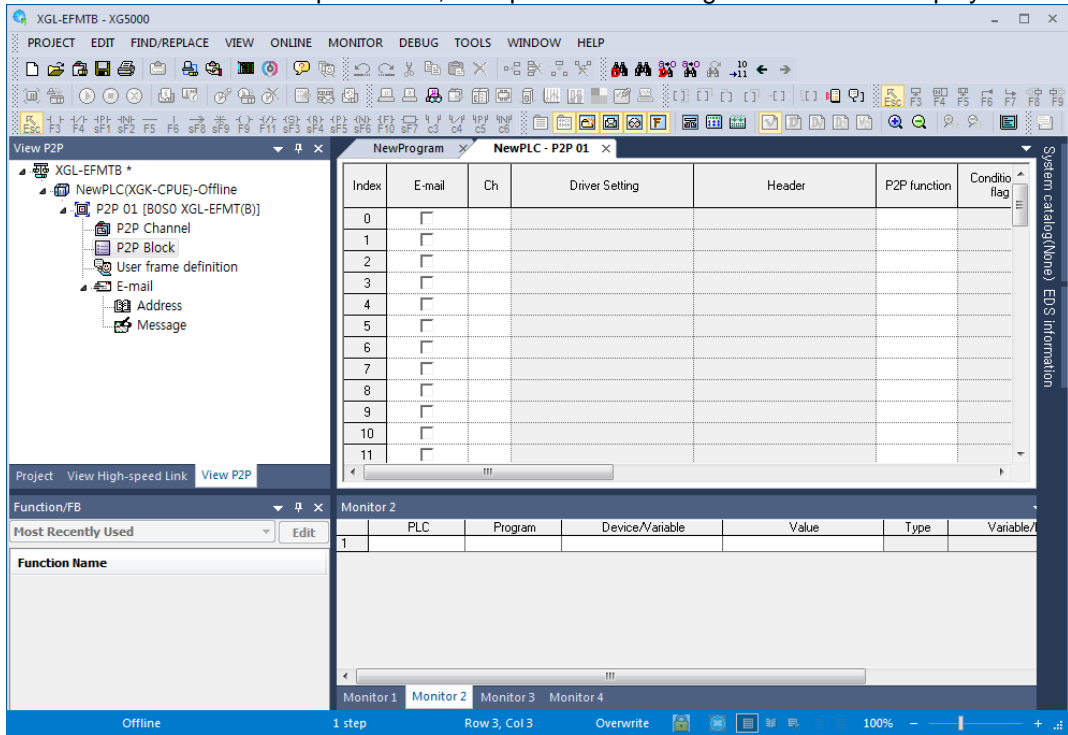

[Table 7.3.5] selection of P2P block

Up to 64 independent blocks are available. If user selects some block at XG5000, user can set the function of block.

Index	E-mail	Ch.	Driver Setting	P2P function	Conditional flag	Command type	Data type	No. of variables	Data size	Frame
0	<input type="checkbox"/>	0	XGT client	READ	F00092	Single	1 BYTE	1		
1	<input type="checkbox"/>									
2	<input type="checkbox"/>									
3	<input type="checkbox"/>									
4	<input type="checkbox"/>									

[Fig 7.3.6] P2P instruction

Each item is as follows

- (1) E-mail  
Used for E-mail service
- (2) Channel  
Select a communication port which will be used by the applicable block.  
The communication port for each block is decided when P2P Channel is setup, which can not be changed during Run.
- (3) Driver Setting  
Indicates communication driver set in P2P setting. When setting channel, driver is loaded automatically according to channel. If it is deleted at P2P channel setting, driver will be deleted automatically. For more detail, refer to CH7.3.2 P2P channel.

- (4) P2P function  
Let the driver execute READ or WRITE
  - 1) READ  
It is used when reading some area of partner device and save them. It is applied to XGT Client and Modbus TCP client driver  
Available memory area: P,M,K,F,T,C,U,Z,L,N,D,R,ZR,%Q,%I,%M etc.
  - 2) WRITE  
It is used when writing the data at some area of partner area. It is applied to XGT Client and Modbus TCP client driver. Single and Continuous Write are supported. Writing at up to 4 independent area is available.  
Available memory area: P,M,K,F,T,C,U,Z,L,N,D,R,ZR,%Q,%I,%M
  - 3) Send  
It is used when sending User defined protocol to external device. It is applied to user frame definition. Memory setting about Variable sized/Fixed sized variable of relevant frame should be set. Before using this function, defining the frame to send is necessary.
  - 4) Receive  
It is used when receiving frame from external device. User can't select same frame about each P2P Frame Receive function block. Rx function block about Rx frame determines one.
- (5) Condition flag  
Define the condition to operate P2P block. A bit device is available for condition flag and the P2P block will be operated at the rising edge of the condition flag.
- (6) Command type  
Decide details of Read operation. Single and Continuous are available for Instruction Type. Up to 4 memory areas are available for Single Read function, and Continuous Read reads as many bytes as defined on the 'Data Size' item.
- (7) Data type  
Define the format of the data the block will process. Bit, Byte, 2bytes (Word), 4bytes (Double Word) and 8bytes (Long Word) data can be processed in Single read function and BYTE only is available for Continuous read function.
- (8) Number of variables.  
It is activated when 'Single' is selected in the 'Instruction' field. Decide the number of areas to read. Up to 4 is available.
- (9) Data size  
It is activated when 'Continuous' is selected in the 'Instruction' field. Since BYTE is fixed in the Data type when XGT Client driver is used, Data Size can be assigned in BYTE size.
- (10) Frame  
Selects the relevant frame (Group) to execute communication in case of User frame definition

(11) Setting

When setting XGT client or user definition frame, it defines the memory area to send/receive. In case of TX, it sets the area to send (M0000) and to save the data from partner device.

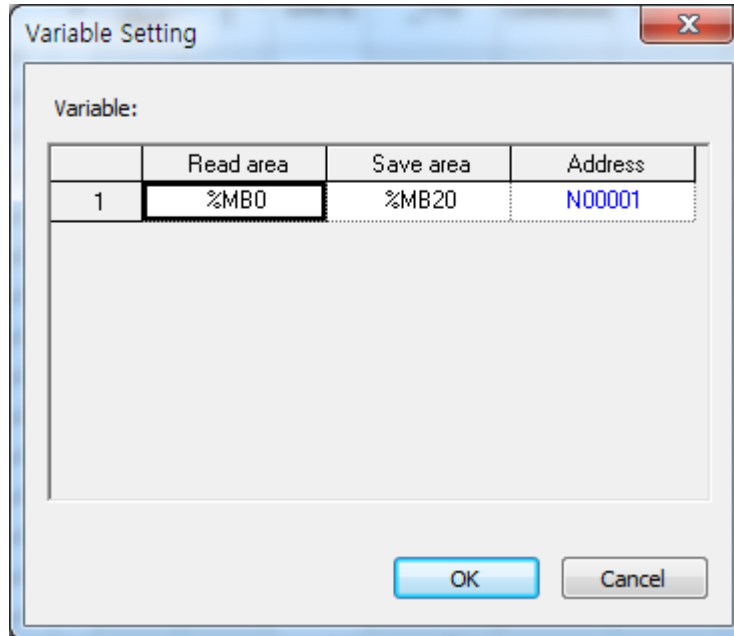

The image shows a dialog box titled "Variable Setting" with a close button (X) in the top right corner. Below the title bar, the text "Variable:" is displayed. A table with four columns is shown: "Read area", "Save area", and "Address". The first row contains the values "%M00", "%M020", and "N00001". The "Read area" cell is highlighted with a black border. Below the table is a large empty rectangular area. At the bottom of the dialog box are two buttons: "OK" and "Cancel".

	Read area	Save area	Address
1	%M00	%M020	N00001

### 7.3.4 User Defined Frame

Send/Receive frames must be defined if there are frames to be sent or received whose structure is different from the structure of XGT dedicated frame or Modbus TCP frames in the network. This is available only in P2P service.

All the frames are composed of Header, Data and Tail which can be omitted respectively.

In XGT, user defined frames are displayed with group name and frame name whose details are as follows;

(1) Group

- 1) Group of frames with identical header and tail.
- 2) Group registration surely necessary for the frame registration.

(2) Frame

- 1) Composed of Header, Body and Tail
- 2) Send/Receive frame shall be defined
- 3) Fixed and Variable size variables can be added to Body
- 4) Frame is composed of lots of segments, and up to 4 variable segments can be registered for a Body.

(3) Type of segments

Header, Body and Tail of the frame are composed of lots of segments, which can be registered on the frame edit window as below.

Segment	Frame	Size	Data	Assign memory	Conversion	Swap	Memory
00	Numerical constant	1	01	<input checked="" type="checkbox"/>			
01	String Constant	4	TEST	<input checked="" type="checkbox"/>			

[Fig. 7.3.7] Register of Segments

Segments used to configure the frame are numerical constant, String Constant, Fixed or Variable size variables.

Segment	Frame	Size	Data	Assign memory	Conversion	Swap	Memory
	Numerical constant			<input type="checkbox"/>			
	String Constant			<input type="checkbox"/>			

[Fig. 7.3.8] Add segment screen

1) Numerical constant

The part to be fixed as Constant shall be defined among frames, with the value of the data item specified in hexadecimal.

	Segment	Frame	Size	Data	Assign memory	Conversion
	00	Numerical constant	3	123456	<input type="checkbox"/>	
					<input type="checkbox"/>	

[Fig. 7.3.9] Numerical constant to select and input

2) String Constant

String Constant shall be registered among frames, with the value of the data item specified in ASCII code.

<input type="button" value="Up"/> <input type="button" value="Down"/> <input type="button" value="Add BCC"/> <input type="button" value="Add Line"/> <input type="button" value="Delete Line"/>						
	Segment	Frame	Size	Data	Assign memory	Conversion
	00	String Constant	4	ABCD	<input type="checkbox"/>	
					<input type="checkbox"/>	

[Fig. 7.3.10] String Constant to select and register

3) Fix sized variable

It is available only in the Body area of the frame, and used to process data whose size is as long as defined value (size is of Byte). Check "Assign memory" to read data from PLC memory when send frame is registered and save the received data on PLC Memory when receive frame is registered. Conversion and swap processing are available for the data when FENet module read data from PLC memory or save data on PLC memory.

<input type="button" value="Up"/> <input type="button" value="Down"/> <input type="button" value="Add BCC"/> <input type="button" value="Add Line"/> <input type="button" value="Delete Line"/>						
	Segment	Frame	Size	Data	Assign memory	Conversion
	00	Fix sized variable	4		<input type="checkbox"/>	

[Fig. 7.3.11] Fix sized variable to select and register

4) Variable sized variable

a) Available in the Body area of the frame

b) Send Frame

Used to change the length of frame.

Check “Assign memory” to configure the send frame with the data read from PLC memory.

c) Receive Frame

(a) Used to process the Variable sized data among the received frames.

(b) Registration available only in the last segment in the Body area.

Check “Assign memory” to save the data for the applicable segment among the received frames. (Swap and conversion are available)

Segment	Frame	Size	Data	Assign memory	Conversion	Swap	Memory
00	Variable sized variable			<input checked="" type="checkbox"/>	NONE	NONE	

[Fig. 7.3.11] Variable sized variable to select and register

(4) Data Conversion Processing

In order to convert data from Hexadecimal to ASCII code when frames are sent and received, or execute Byte swap, the applicable setting shall be specified on the frame edit window.

1) Conversion

- Hex To ASCII

Send: converts read data from PLC memory to ASCII code so to configure send frame.

Receive: converts received data to ASCII so to save.

- ASCII To Hex

Send: converts read data from PLC memory to Hexadecimal code so to configure send frame.

Receive: converts received ASCII code data to Hexadecimal code so to save.

Segment	Frame	Size	Data	Assign memory	Conversion	Swap
00	Variable sized variable			<input checked="" type="checkbox"/>	NONE	NONE

[Fig. 7.3.13] Data processing method to select

If 2 Words of PLC memory, MW100/101, are used for Send frame configuration, and the ASCII code 0x34353637 is saved on MW100/101, the applicable segment of the send frame will be filled with hexadecimal number '4567', when 'Hex To ASCII' is selected.

And when some of the received frames are saved as converted to Hex, 0x3435 3637 will be saved on PLC memory, if the value of applicable area is “4567”.

2) SWAP

- 2 Bytes : 2 Bytes swap of applicable part among Send/Receive frames
- 4 Bytes : 4 Bytes swap of applicable part among Send/Receive frames
- 8 Bytes : 8 Bytes swap of applicable part among Send/Receive frames

If h1234567811223344 is converted by respective methods above, its results are as follows;

- 2 Bytes swap : h3412785622114433
- 4 Bytes swap : 7856341244332211
- 8 Bytes swap : 4433221178563412

## 7.4 P2P Service Operation

After P2P parameters are specified, download the parameters onto PLC CPU and start the P2P service. It is supposed that P2P parameters to download are already prepared and connection is available with the applicable PLC CPU.

### (1) P2P parameters downloading

In order to download the prepared P2P parameters, select [Online] → [Write] on XG5000 menu window to display the parameters downloading window, where registered basic setting, P2P parameters and HIGH-SPEED link parameters can be selected.

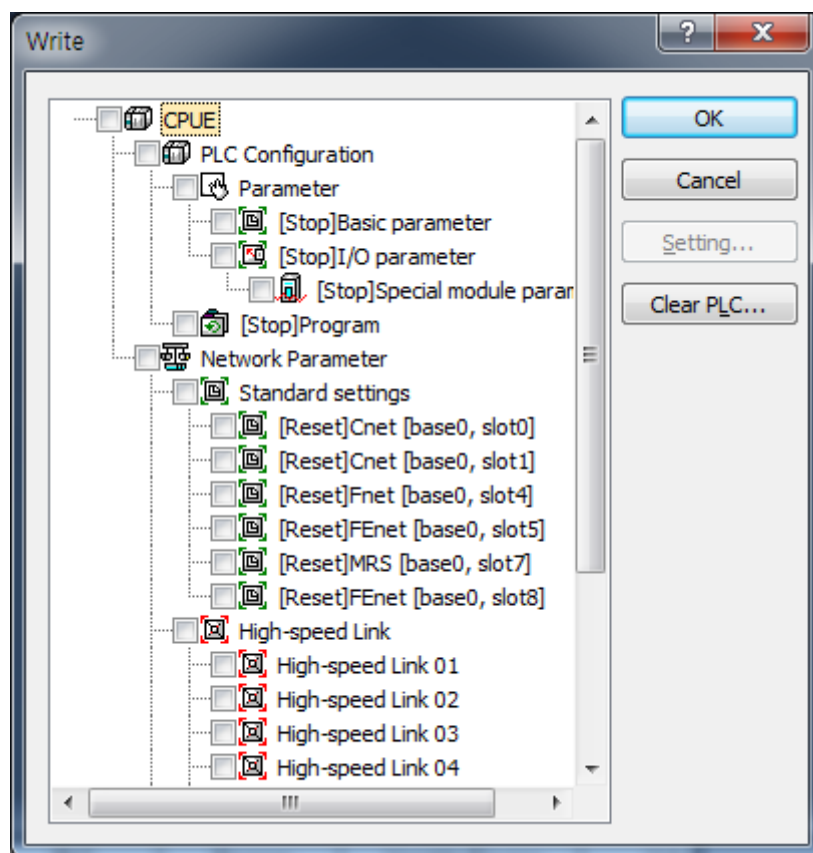

[Fig. 7.4.1] P2P parameters downloading

Among P2P 0~7, only the prepared P2P parameters will be displayed after sorted, where P2P parameters to download will be selected.

Click OK to download the P2P parameters onto CPU.

### (2) P2P service start

Even after P2P parameters are downloaded, P2P shall be started in order to start the P2P service. Select [Online] -> [Communication module setting] -> [Enable Link] (HS link, P2P)] on the menu.

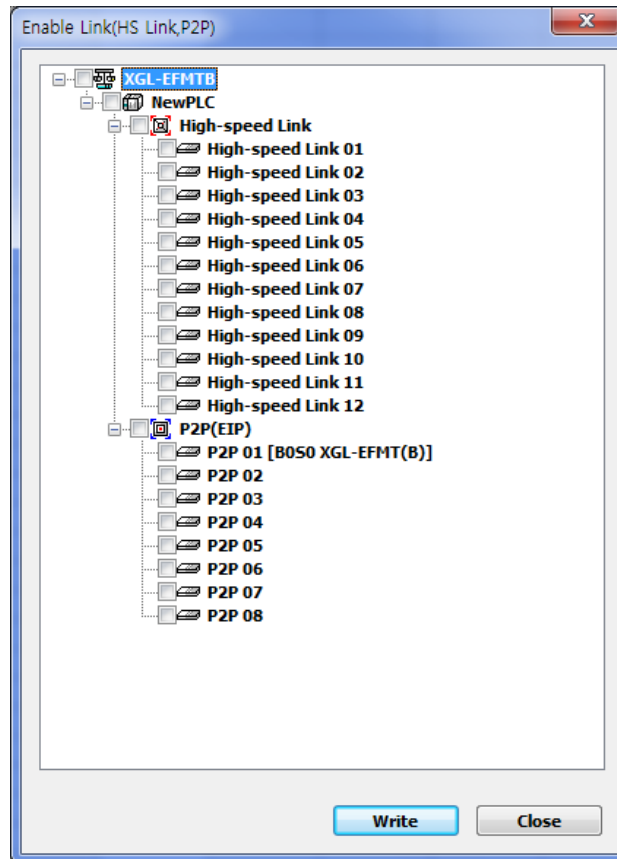

[Fig. 7.4.2] Enable setting of P2P service

Select P2P parameters to start on the [Enable Link (HS link, P2P)] window. The P2P parameters already checked is during run, whose P2P service will stop if cancelled.

In order to confirm normal downloading and normal P2P service operation, select [System Diagnosis] on the menu.

## 7.5 P2P Diagnosis Function

Diagnosis function of P2P system is used to display the service status and information of the communication program after the driver of the communication module is specified. The user can check the normal P2P service through the diagnosis system. Refer to Chapter 5 XG5000 Program for more details.

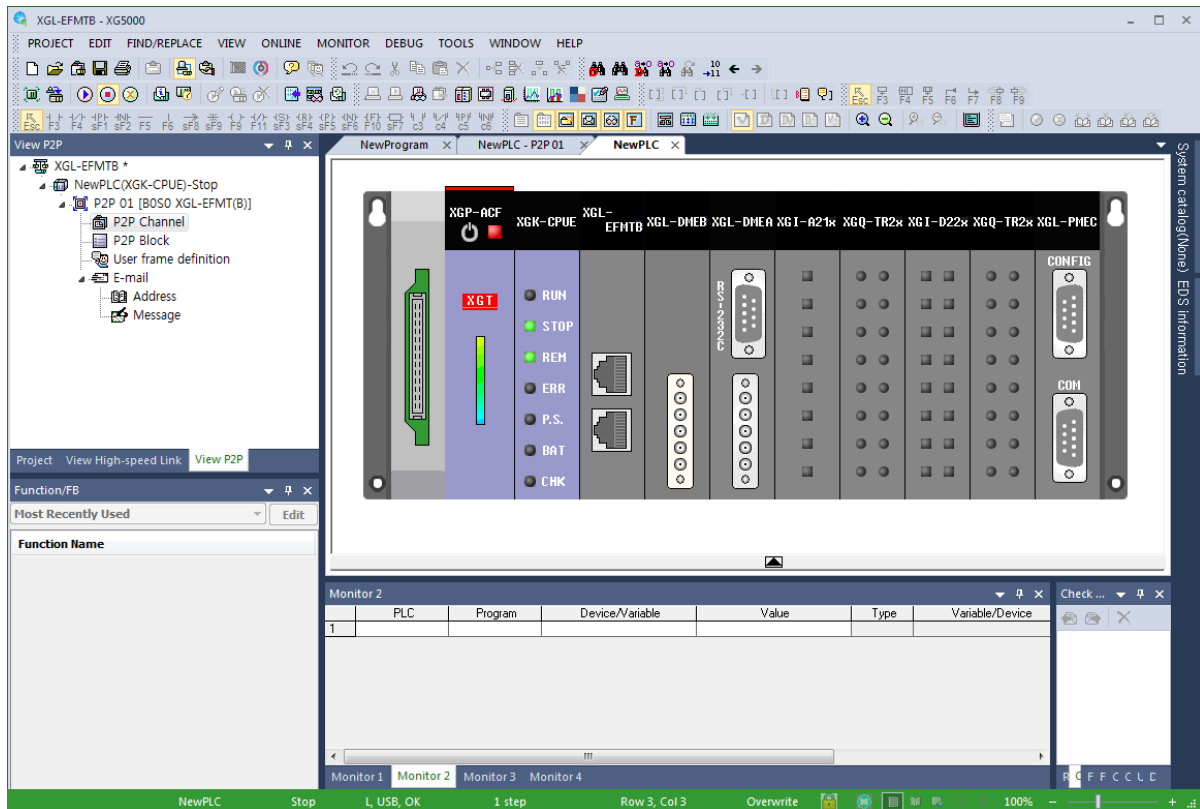

[Fig. 7.5.1] Information of system diagnosis module

### 1) P2P service

It is used to display detailed information on the user defined service executed, check and read the service status if P2P parameters are set and enabled, where real-time monitoring is available with Individual Read or Continuous Read specified on the menu.

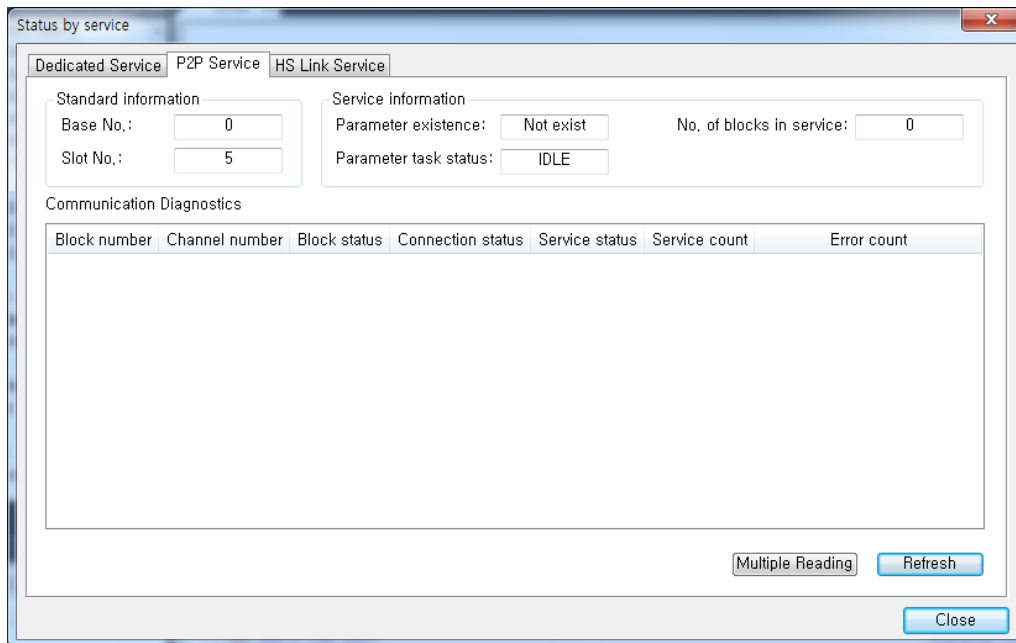

[Fig. 7.5.2] P2P service monitor

## 7.6 E-mail service using P2P service

### 7.6.1 E-mail service

When there's problem, E-mail service can be used to notify the problem to manager. When status of CPU is changed or specific event occurs, it notified the status to manager by using E-mail or SMS service. But there is some restriction to use E-mail service. It supports ASCII and Decoding for security is not supported. Since authorization function is not supported, set the mail server not to do authorization process for TX.

#### (1) E-mail setting of P2P service

Double-click "E-mail" to activate the E-mail setting window

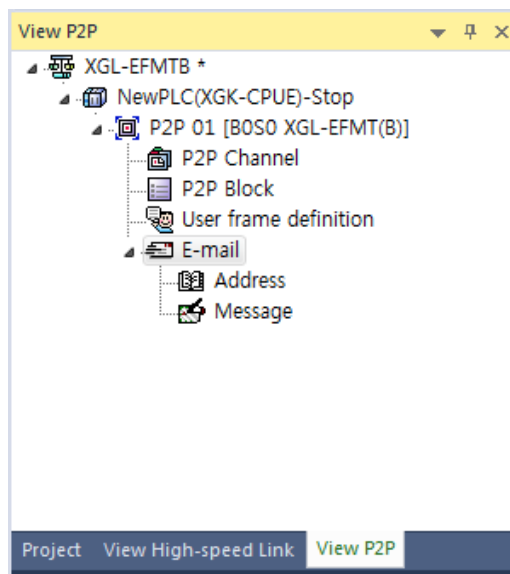

[Fig 7.6.1] P2P project window (E-mail)

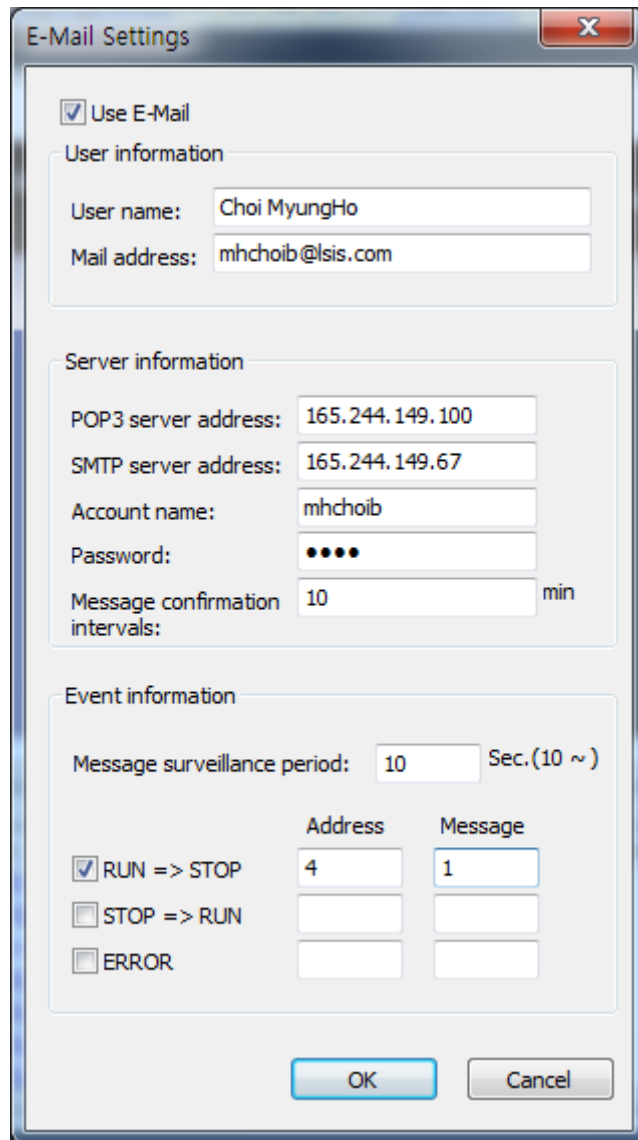

[Fig 7.6.2] E-mail setting window

Item		Details
Use E-Mail		Determines whether to use E-mail service. In order to use E-mail function, check this box.
User information	User name	User name seen when partner receives the mail. If it is set as PLC, PLC will be name of E-mail sender.
	Mail address	E-mail address for reply Though PLC sends E-mail, other PC can receive the reply about E-mail PLC sent.

	Item	Details
Server information	POP3 server address	Server addresses receiving the E-mail from other device. Any mail server supporting POP3 can be used
	SMTP server address	Server addresses sending the E-mail to other device. Any mail server supporting SMTP can be used
	Account name	Account name in the POP3 which should be same with mail address
	Password	Password to access POP3 account
	Message confirmation intervals	Time of confirmation whether E-mail arrived or not

Event information monitors the CPU status periodically. If PLC becomes Stop mode or error status, communication parameter can't operate so this function is provided to prepare the Stop mode or error status.

	Item	Details
Event information	Message surveillance period	Set to be larger than 10s. Time for checking whether PLC mode is changed.
	RUN -> STOP	Communication sends message when mode of PLC is changed from Run to Stop
	STOP -> RUN	Communication sends message when mode of PLC is changed from Stop to Run
	ERROR	Communication sends message when error occurs regardless its status.

(2) Writing address and message

1) Writing address

Double-click 'Address' to activate the following screen

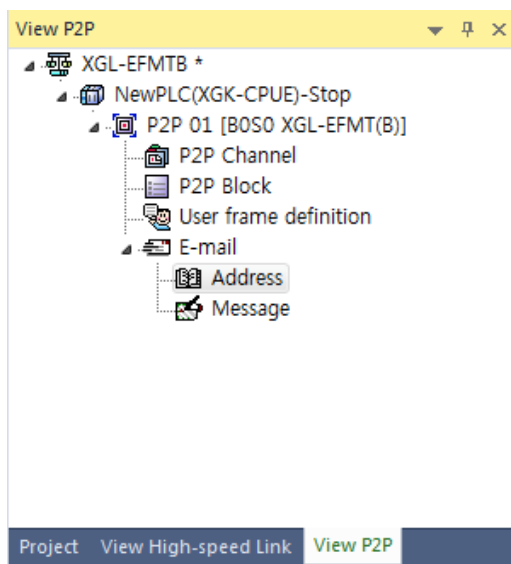

[Fig 7.6.3] E-mail setting (address setting)

Register the address to send E-mail on the following screen

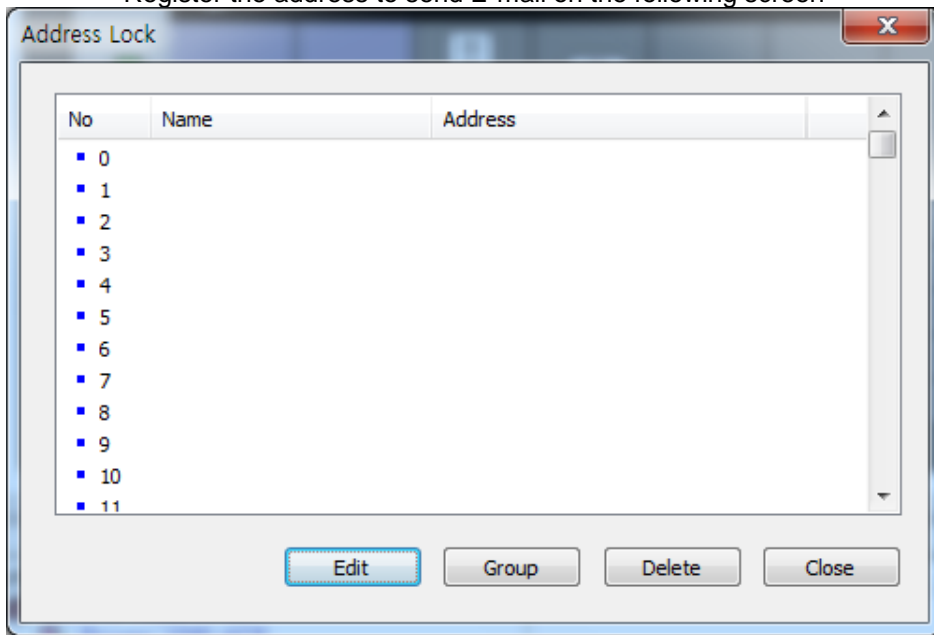

[Fig 7.6.4] Setting screen of Address Lock

Select the No and press Edit or double-click the No to active the following screen

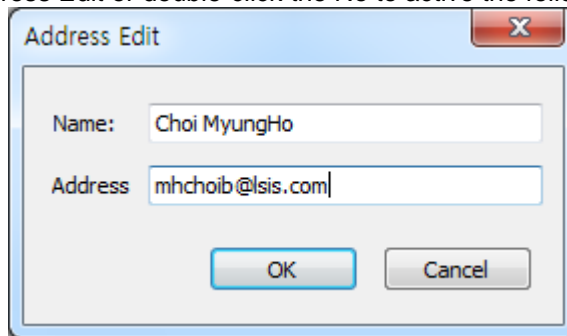

[Fig 7.6.5] Address Edit window

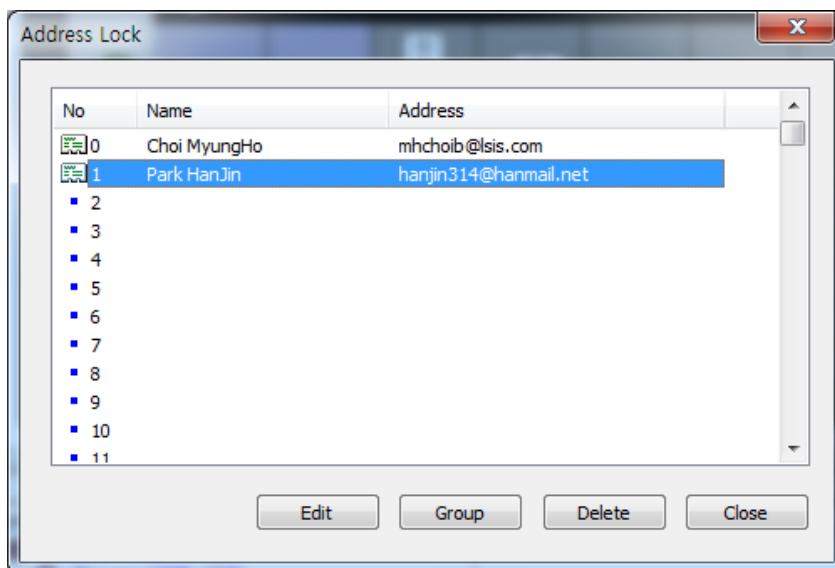

[Fig 7.6.6] complete screen of Address Lock

When sending E-mail to group, press Group

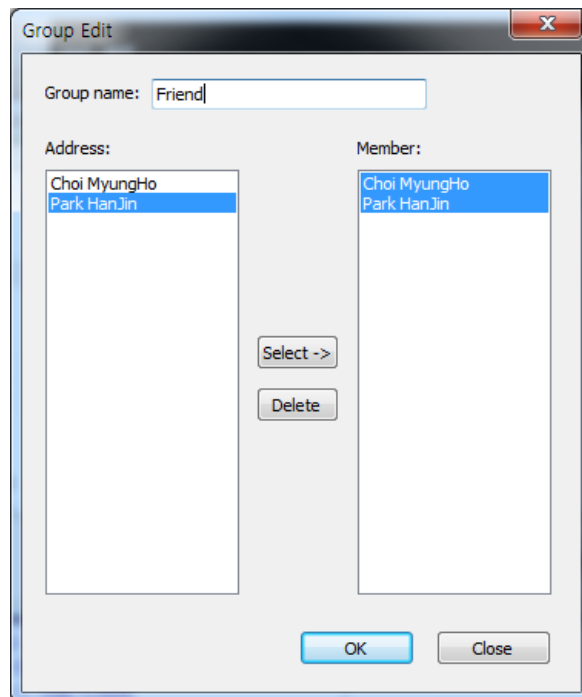

[Fig 7.6.7] Group setting screen

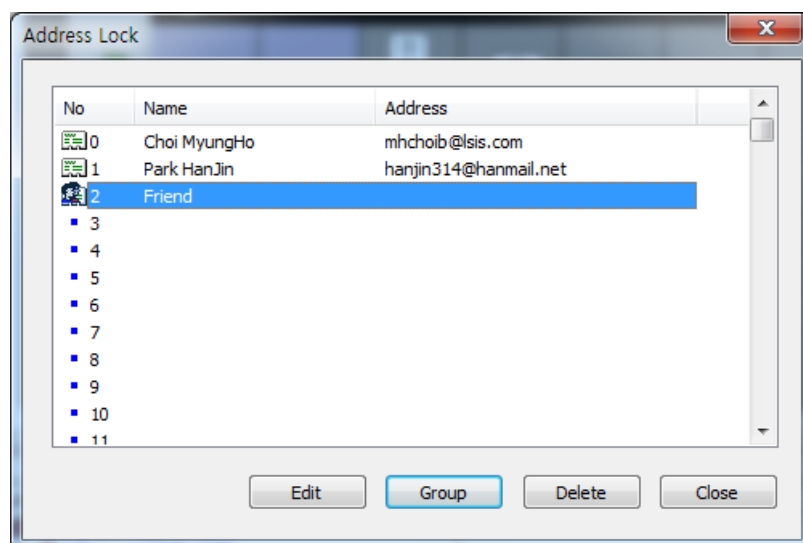

[Fig 7.6.8] complete screen of Address Lock (including Group)

If you select Group, already registered individual address is indicated at left side. Select individual to be member of group and press OK to create Group address. In the above screen, if you send to Friend, ParkHanJin and Choi MyungHo will get message simultaneously.

- 2) Writing message  
Press "Message" to edit message

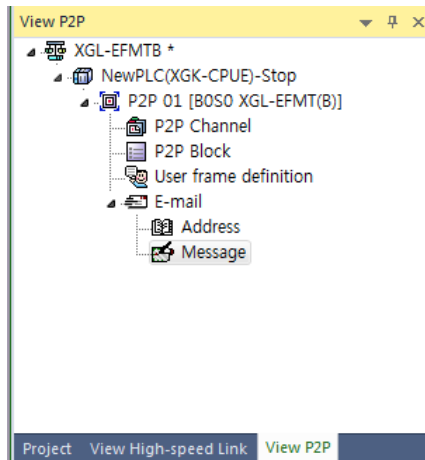

[Fig 7.6.9] P2P project window (Message setting)

The following figure is message edit window

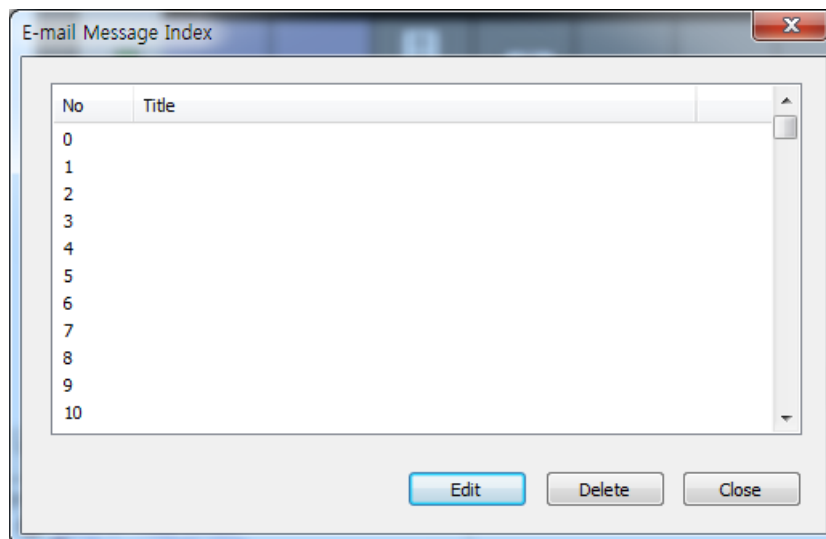

[Fig 7.6.10] E-mail message registration window

Click "Add" to activate the following screen. Set the Form and Size and write the message data. Form is classified into String and Byte data receiving from CPU. Form MB is used to send as many message data of P2P ESend parameter as byte set in Size  
"Change" is used to change the line when outputting data at the received screen.

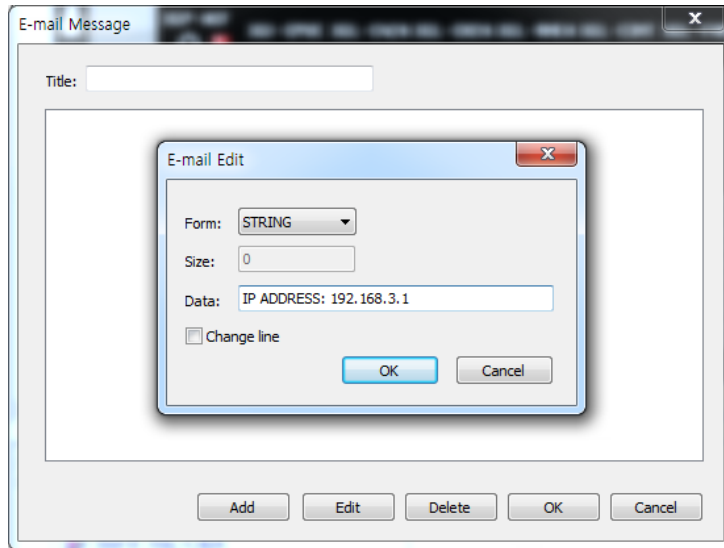

[Fig 7.6.11] E-mail message edit window

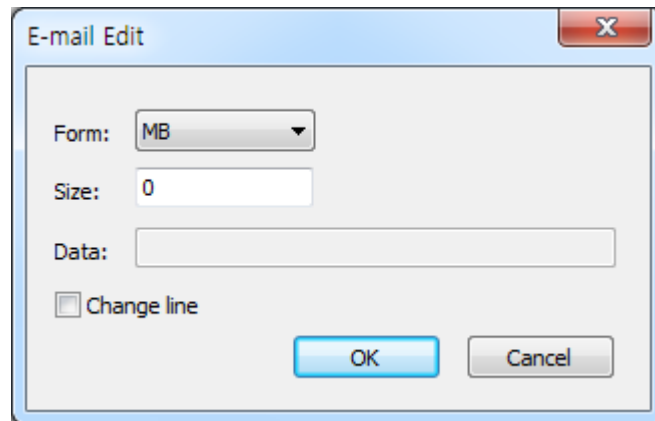

[Fig 7.6.12] E-mail Edit setting (MB)

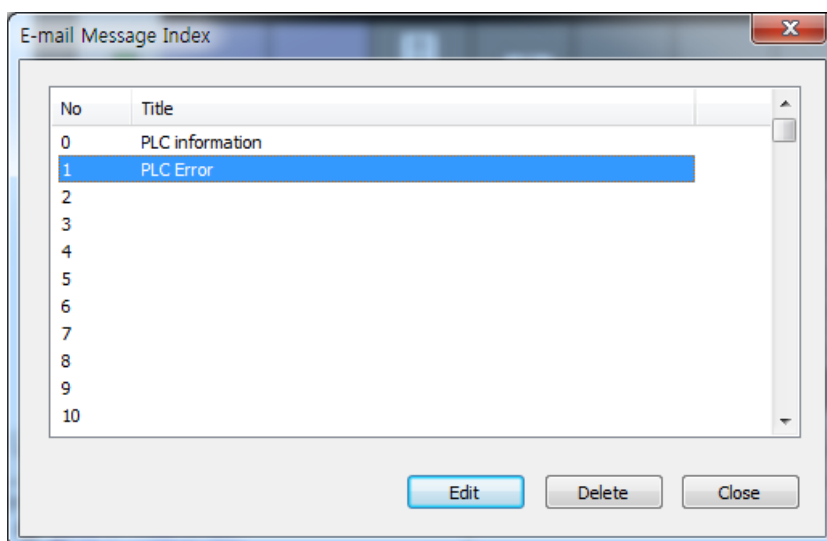

[Fig 7.6.13] Registration result screen of E-mail message

### (3) Setting of P2P block

Sets the parameter of P2P block to send message set in the previous steps

If setting the E-mail button after clicking the P2P block, P2P instruction can be selectable.

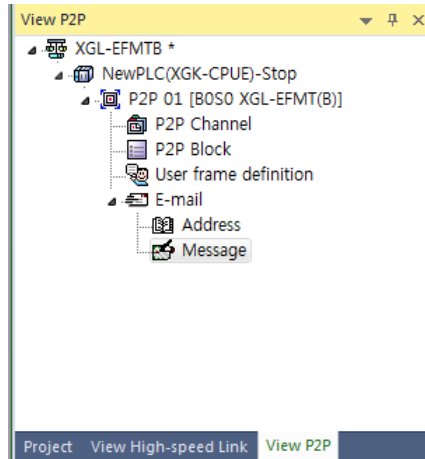

[Fig 7.6.14] P2P project window (P2P block)

Index	E-mail	Ch.	Driver Setting	P2P function	Conditional flag	Data size	Setting	Variable setting contents
0	<input checked="" type="checkbox"/>			ESEND	%MX0		Setting	Line:3Mail Message Number:0Mail Address Number:0Mail data:%MX0
1	<input checked="" type="checkbox"/>			ERECEIVE	%MX1		Setting	Line:2Mail information:%MW100Mail message:%MW200
2	<input type="checkbox"/>						Setting	

[Fig 7.6.15] P2P parameter setting window

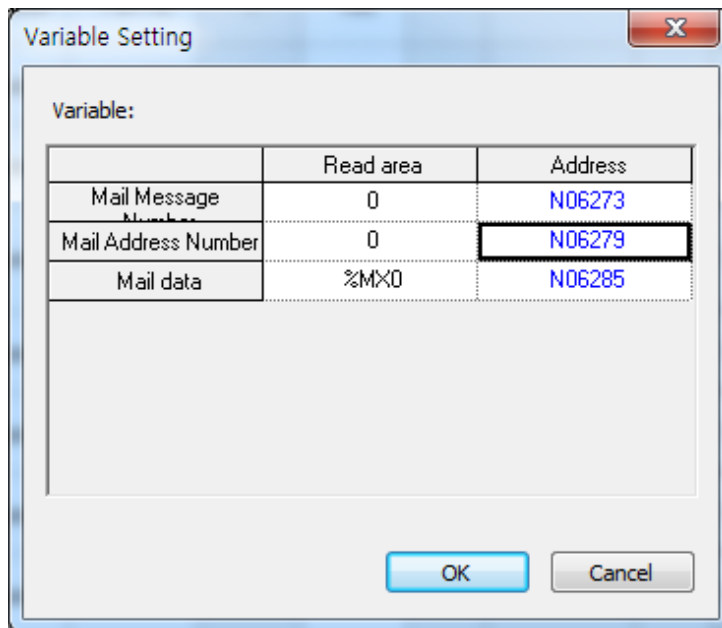

[Fig 7.6.16] Setting screen in case of E-mail TX

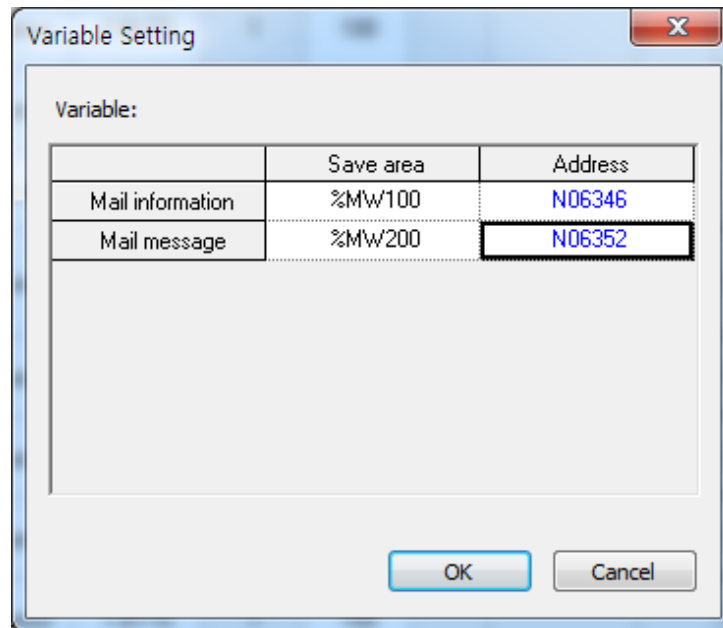

[Fig 7.6.17] Setting screen in case of E-mail RX

Item		Details	
E-mail		Enables the E-mail service	
P2P function	ESEND	Sends E-mail	
	ERECEIVE	Receives E-mail	
Conditional flag		Inputs device to use as start condition Memory area and flag are available	
Setting	ESend	Mail message number	Inputs index number of message list among the E-mail setting in P2P Determines title and data of mail
		Mail address number	Sets registration number set in Address Lock. Determines who to send When you want to send many people, use Group. But before using Group, the address of partner should be inputted. The number of Group member is limited to maximum 10.
		Mail data	Indicates the start address of data to send. It sends as many data as the number of array (10 byte) starting the first of array applying to MB[10].
	ERECEIVE	Mail information	Area where mail information is saved
		Mail message	Saves the received mail message at memory of PLC

**7.7 P2P service at Redundant System**

In case of P2P service, if you want to take data of redundant system, don't use P2P Write at XGR side and Set READ at XGK(I) side by using flag of P2P service. Save the normal service count of P2P service connected to A-Side and B-Side and after you check if the STATUS of relevant block is 0 or not, take the data of one side by checking STATUS is 0 and normal service count increases.

- (1) In case XGR and XGK(I) are configured as redundant system by using different IP address at single network, since P2P service have to configure service with different one block, you can write ladder program like the figure below.

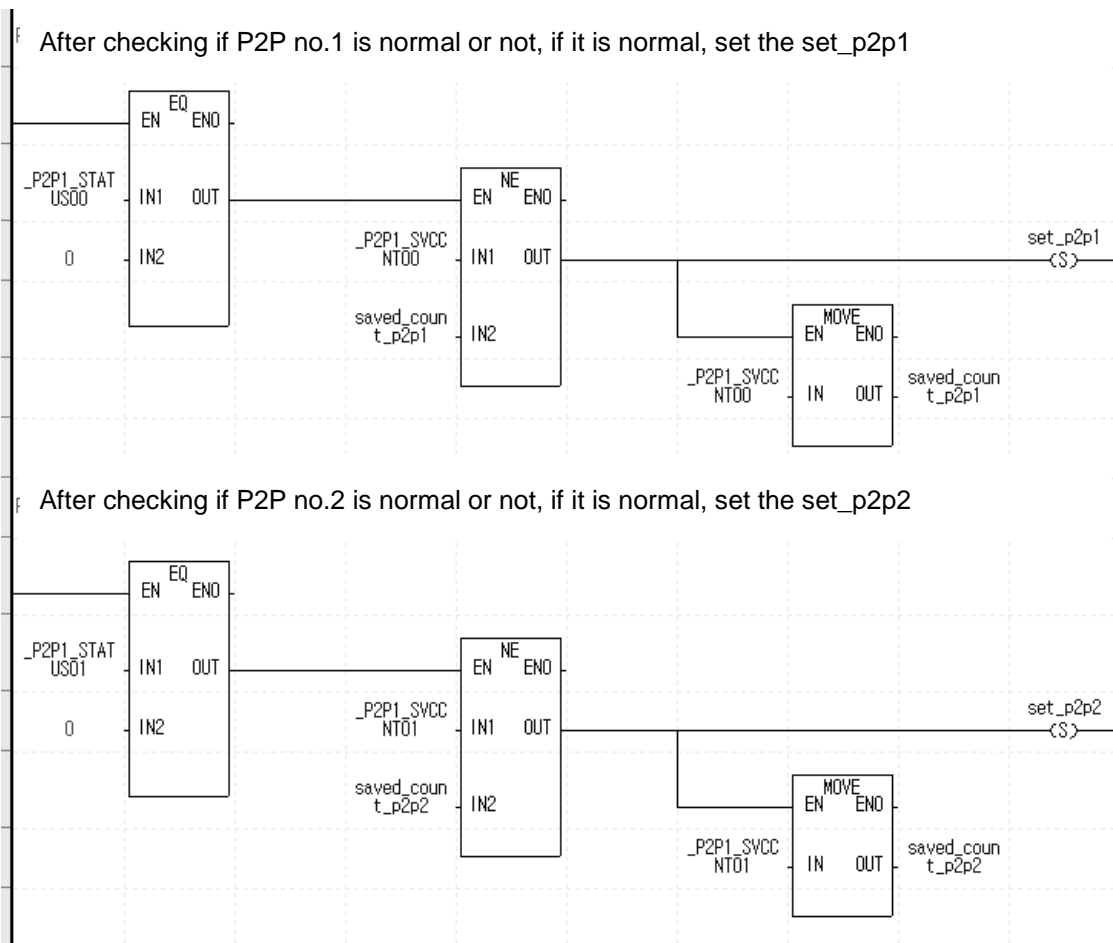

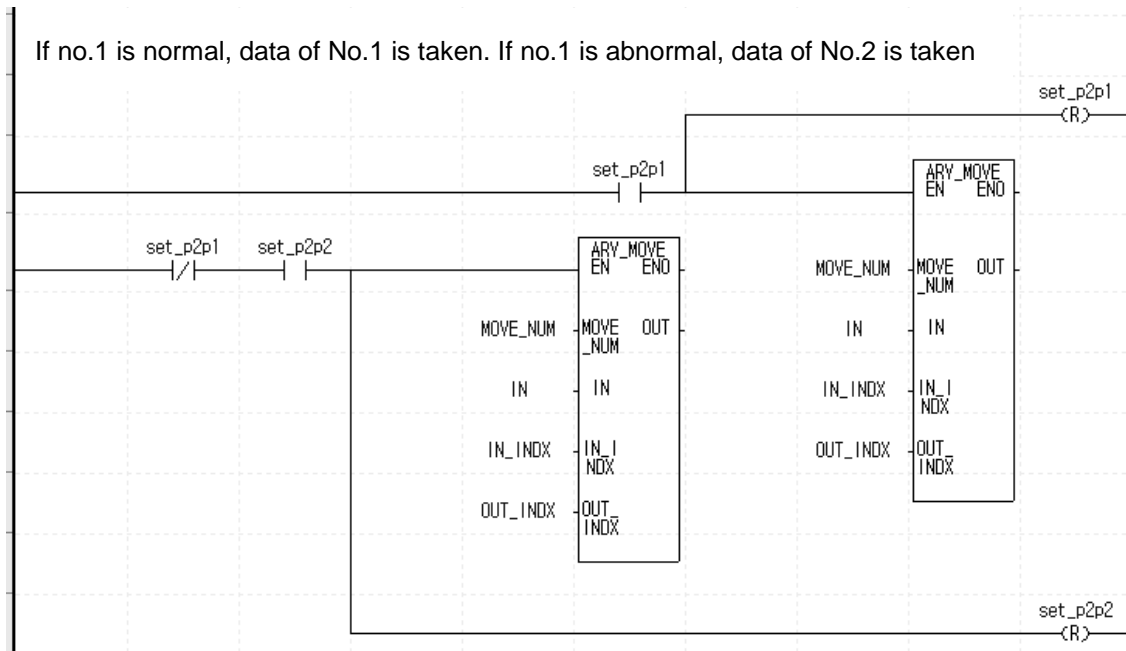

(2) In case XGR and XGK(I) are configured as redundant system with different IP address at the separated network, P2P service connected to Master (standby) is no.1 and P2P service connected to Standby (master) is no.2. If you write ladder about P2P block no.0, you can write the ladder like figure below.

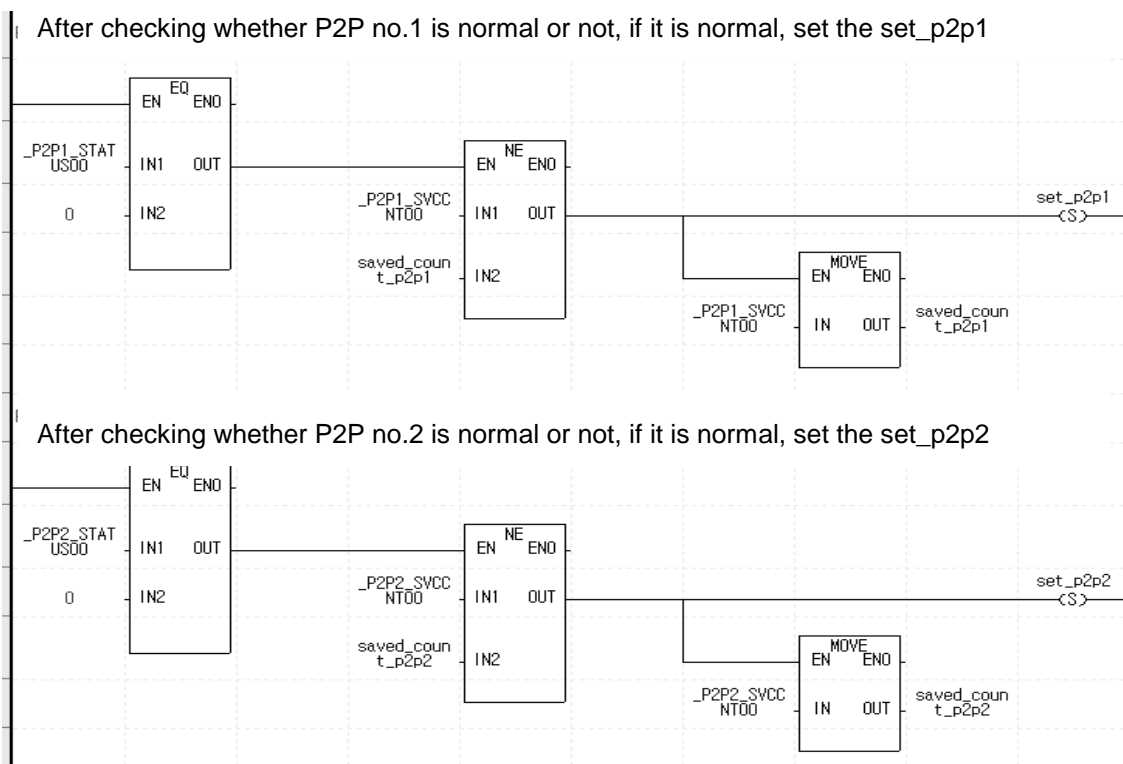

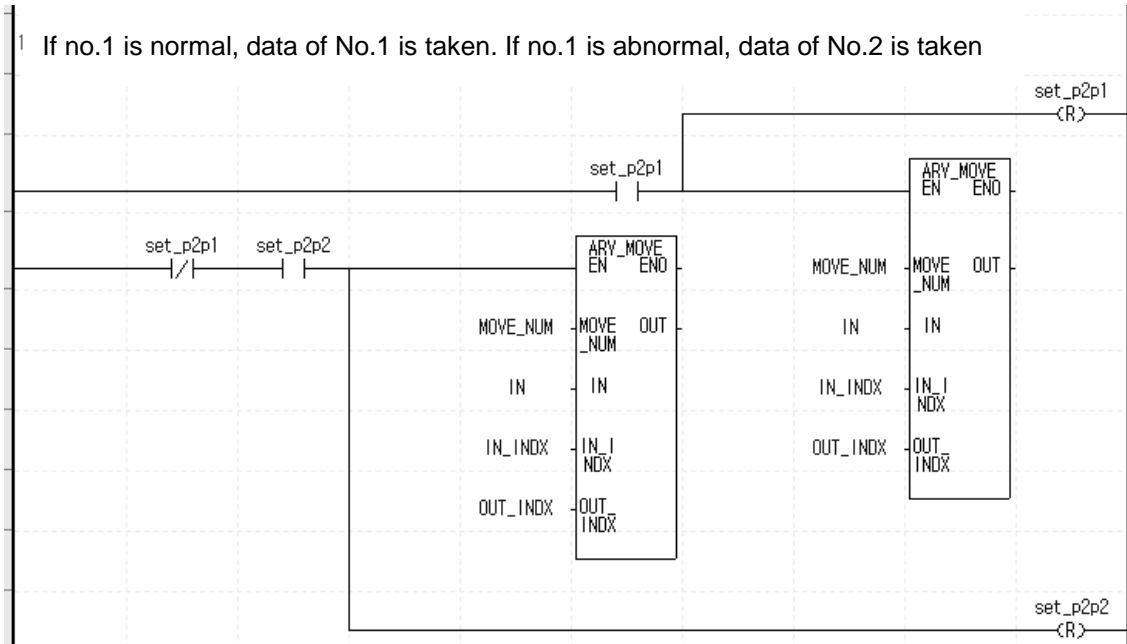

- (3) In case XGR and XGK(I) are configured as redundant system with same IP address at the separated network, only standard setting is different with (2). You can configure the redundant system by using same ladder program to configure redundant system.

## Chapter 8 Dedicated Communication

### 8.1 Dedicated Communication

#### 8.1.1 Introduction

The dedicated communication service is reading and writing information and data of PLC from/on PC and associated devices with the protocol built-in FENet I/F module.

The FENet I/F module operates as a server in the network and responds to memory Read/Write request instruction with XGT dedicated protocol or MODBUS TCP protocol by Computer or external devices. It uses 2004 and 2005 for TCP and UDP port number of XGT dedicated driver, respectively and 502 for the port number of MODBUS TCP driver. This service mainly used to communicate between higher level system (PC program, MMI) and LS Ethernet module or between LS Ethernet modules.

(1) Setting of XGT dedicated driver

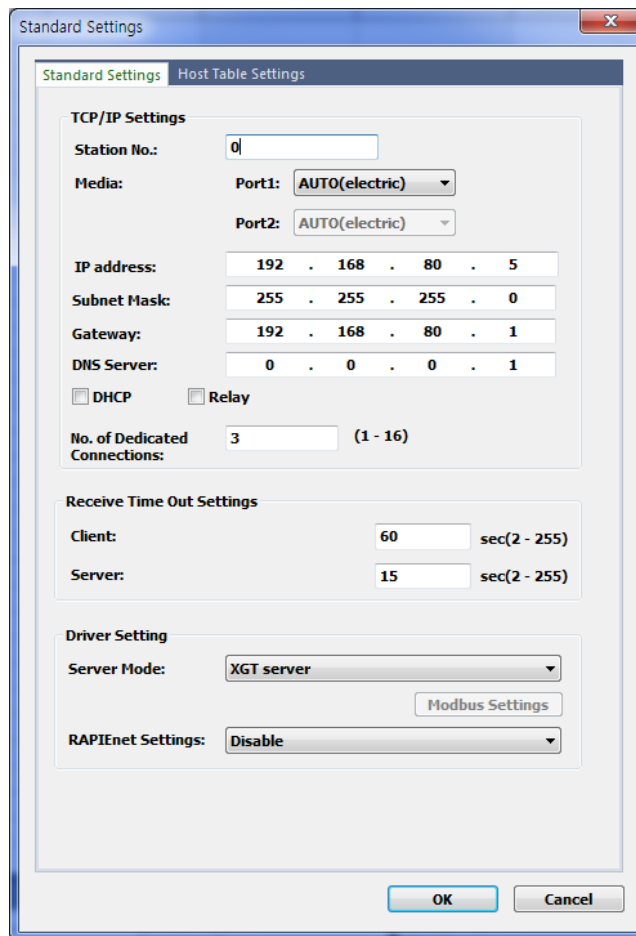

[Fig. 8.1.1] Driver setting screen

As basic parameters shall be surely specified and downloaded prior to use in the Ethernet communication, the dedicated communication services shall be also surely specified and downloaded for its application (XGT server if not specified).

The number of dedicated connections in the basic parameters is the number of channels (MMI connections) connected through LS dedicated port (2004).

(In case of V6.0 or above, up to 64 per TCP server port can be set.)

Thus, by changing the number of dedicated connections on the frame editor, the number of channel connections for LS dedicated communication can be changed.

### 8.1.2 Frame structure

The structure of LS Ethernet module's application frame is as shown below;

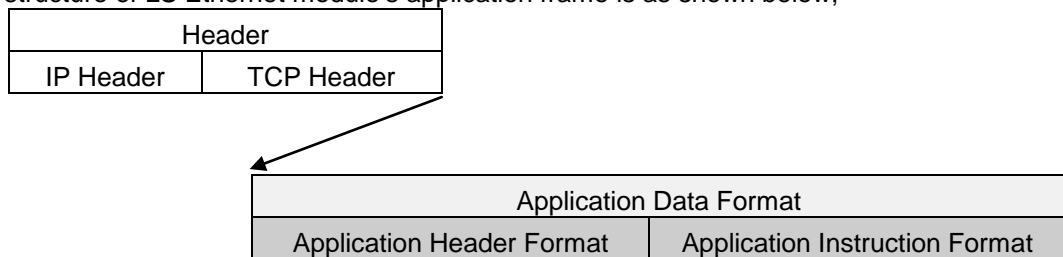

#### (1) Header Structure (Application Header Format)

Item	Size(byte)	Description
Company ID	8	"LSIS-XGT" + "NULL NULL(reserved area)" (ASCII CODE : 4C 53 49 53 2D 58 47 54 00 00)
Reserved	2	h00 : Reserved area
PLC Info	2	* Client(MMI) → Server(PLC) : Don't care (h00) * Server(PLC) → Client(MMI) : Bit 00~05 : CPU TYPE 01(XGK/R-CPUH), 02(XGK-CPUS), 05(XGI-CPUU) Bit 06 : 0(Redundancy Master / Single), 1(Redundancy Slave) Bit 07 : 0(CPU normal operation), 1(CPU error) Bit 8~12 : System status 1(RUN),2(STOP), 4(ERROR), 8(DEBUG) Bit 13~15 : Reserved
CPU Info	1	It is determined to be the XGK/I/R series through a reserved area XGK: 0xA0,XGI: 0XA4,XGR: 0xA8
Source of Frame	1	* Client(MMI) → Server(PLC) : h33 * Server(PLC) → Client(MMI) : h11
Invoke ID	2	ID used to discriminate the sequence among frames (This number is sent as attached to Response frame)
Length	2	Byte size of application Instructions.
FEnet Position	1	Bit 0~3 : FEnet I/F module's Slot No.

## Chapter 8 Dedicated Protocol Communication

---

		Bit 4~7 : FEnet I/F module's Base No.
Reserved 2 (BCC)	1	h00 : Reserved area (Application Header's Byte Sum)

(2) Basic Structure of Frame (Application Instruction Format)

1) Header

Company ID (‘LSIS- XGT’)	Rese rved (2)	PLC information area (2)	CPU Info (1)	H33 (1)	Invoke ID (2)	Length (2)	Reserved area (1)	BCC (1)
--------------------------------	---------------------	--------------------------------	--------------------	------------	------------------	---------------	-------------------------	------------

\*\* Figure in ( ) means the number of bytes.

- ▷ Company ID: ‘LSIS-XGT’ in ASCII text
- ▷ Reserved: area to match the character string number with LGIS-GLOFA
- ▷ PLC Info: Information area for PLC
- ▷ Invoke ID: ID used to discriminate the sequence among frames, which can be set optionally at request instruction. And Response frame resends the received Invoke ID at request instruction (an area used for checking for errors in PC or MMI).
- ▷ Length: Length of the data area at the back of Header in the frame.

2) Data Request frame (external communication device → FEnet I/F module)

Header	Instruction	Data type	Reserved area (2 bytes)	Structurized data area
--------	-------------	--------------	----------------------------	---------------------------

3) ACK Response frame (FEnet module → external communication device, if data is received normally)

Header	Instruction	Data type	Reserved area (2 bytes)	Error status (2 bytes h0000)	Structurized data area
--------	-------------	--------------	-------------------------------	---------------------------------	---------------------------

4) NAK Response frame (FEnet module → external communication device, if data is received abnormally)

Header	Instruction	Data type	Reserved area (2 bytes)	Error status (2 bytes: Not h0000)	Error code (1 byte)
--------	-------------	--------------	-------------------------------	---	------------------------

**Notes**

- 1) If hexadecimal data is applied, the Hexadecimal type of data is indicated with ‘h’ or ‘h’ attached in front of figures inside frame like 01, h12345, h34, h12 and h89AB.

### 8.1.3 Instruction list

Instructions used in dedicated communication service are as shown below in the table.

Instruction	Instruction code	Data type	Processing Details
Read	Request : h0054	Individual	Reads Bit, Byte, Word, Double word and Long word type of variables data based on each data type.
	Response : h0055	Continuous	Reads byte type of variables in block unit. (up to 1,400 bytes).
Write	Request : h0058	Individual	Writes Bit, Byte, Word, Double word and Long word type of variables data based on each data type.
	Response : h0059	Continuous	Writes byte type of variables in block unit. (up to 1,400 bytes).

[Table 8.1.1] List of Instructions

### 8.1.4 Data type

#### (1) Data type of variables

The Data types of variables in the P, M, L, F, K, C, D, T, N, R, etc device areas are to be included after the variable indicating letter of '%'.  
 Example: %PX0, %LX0, %FX0

Data type	Example
Bit	%PX0,%LX0,%FX0
Byte	%MB0, %PB0, %DB0
Word	%PW0,%LW0,%FW0,%DW0
Double Word	%PD0,%LD0,%FD0,%DD0
Long Word	%PL0,%LL0,%FL0,%DL0

[Table 8.1.2] List of data types of direct variables

#### (2) Data type

Data type is to be set to Instruction type when reading or writing direct variables.

Data type	Code	Data type	Code
BIT	h00	LWORD	h04
BYTE	h01	DWORD	h03
WORD	h02	LWORD	h04
DWORD	h03	Continuous	h14

[Table 8.1.3] List of data types of direct variables

## 8.2. Execution of Instructions

### 8.2.1 Read Separated Direct Variable

#### (1) Introduction

This function is used to directly specify the device memory address and the data type to read. Up to 16 separate device memory areas can be read at a time

#### (2) Request format (PC -> PLC)

- Read Request of Individual Variable (MMI → PLC)

Item	Size(byte)	Description
Instruction	2	h0054 : Read Request
Data type	2	Refer to Data Type table(X,B,W,D,L)
Reserved area	2	h0000 : Don't Care.
Number of blocks	2	Number of memory address to read; up to 16
Variable length	2	The number of characters in the Direct variable; Max. 16
Direct variable	Length of variable name	Direct variable only available
...	...	(Repeatedly as many as the number of blocks /up to 16)
Variable length	2	The number of characters in the Direct variable; up to 16 characters.
Direct variable	Length of variable name	Direct variable only available

Format name	Header	Instruction	Data type	Reserved area	Number of blocks	Variable length	Direct variable	...
Code (Ex.)	...	h0054	h0002	h0000	h0001	h0006	%MW100	

1 block (up to 16 blocks setting available repeatedly)

#### 1) Number of blocks

Used to specify the number of blocks composed of '[Variable Length][Variable]' in the request format up to 16 blocks. Accordingly, the value of [Number of Blocks] shall be h0001 ~ h0010.

#### 2) Variable length

It means the number of characters of the variable name which is available up to 16 characters, whose range is h01 ~ h10.

## Chapter 8 Dedicated Protocol Communication

### 3) Variable

Input the address of memory device to be read actually. It shall be ASCII value within 16 characters. Others than figure, capital/small letter, '%' and '.' are not allowed.

Based on the PLC type, available types of variables are as described below.

Classification	Bit	Byte	Word	Double Word	Long Word
XGT memory	%(P,M,L,K,F,T)X	-	%(P,M,L,K,F,T ,C,D,S)W	-	-

[Table 8.2.1] Types of Variables

### Notes

- (1) When the frame is composed with hexadecimal word data to be displayed on the frame above, 'h' in front of figures shall be taken out with the positions of two bytes exchanged as below. Ex.) h0054 ⇒5400

### (3) Response format (For PLC's ACK Response)

- Read Response of Individual variable (PLC →MMI)

Item	Size(byte)	Description
Instruction	2	h0055 : Read Response
Data type	2	Refer to Data Type table
Reserved area	2	h0000 : Don't Care
Error status	2	Normal if it is 0, abnormal if not 0.
Error code	2	If Error State is abnormal, the lower Byte is the error code.
Number of blocks		If Error State is normal, it means the number of blocks to be read.
Data size	2	The size of data in byte unit.
Data	Data size	Data read.
...	...	(Repeatedly as many as the number of variables /up to 16)
Data size	2	The size of data in byte unit.
Data	Data size	Data read.

Format name	Header	Instruction	Data type	Reserved area	Error status	Number of blocks	Data Size	Data	.....
Code (Ex.)	...	h0055	h0002	h0000	h0000	h0001	h0002	h1234	

1 block (up to 16 blocks)

1) Data Size

It means the number of bytes in Hexadecimal. This number is decided based on the memory type (X,B,W,D,L) included in variable name of the computer request format.

2) Number of blocks

Used to specify the number of blocks composed of '[Number of Data][Data]' in the request format up to 16 blocks. Accordingly, the value of [Number of Blocks] shall be h0001 ~ h0010.

Classification	Available variables	Number of data (Byte)
Bit (X)	%(P,M,L,K,F,T)X	1 (Lowest bit only effective)
Word (W)	%(P,M,L,K,F,T,C,D,S)W	2

[Table 8.2.2] Number of data based on variables

Notes
<p>1) Number of data 'H04' means that 4 bytes of Hexadecimal data (Double Word) exists in the data.</p> <p>2) If data type is Bit, the read data will be displayed in one byte (HEX). In other words, if BIT value is 0, h00 will be displayed, and if the value is 1, h01 will be displayed.</p>

4) Response format (For NAK Response)

Format name	Header	Instruction	Data type	Reserved area	Error status	Error code (Hex 1 Byte)
Code (Ex.)	...	h0055	h0002	h0000	hFFFF (other than 0)	h21

Notes
<p>(1) Error code displays the type of error in 1 byte of Hexadecimal. Refer to 'Error Codes Table' for more details.</p>

### 8.2.2 Read Continuous Direct Variable

#### (1) Introduction

This function is used to read the data of directly defined PLC device memory continuously as many as specified from the address specified.

#### (2) Request format (PC ⇒ PLC)

##### ■ Read Request of Continuous Variable (MMI → PLC)

Item	Size (byte)	Description
Instruction	2	h0054 : Read Request
Data type	2	h0014 : Continuous
Reserved area	2	h0000 : Don't Care.
Number of blocks	2	It is fixed with h0001 for Continuous read.
Variable length	2	The number of characters in the variable field; Max. 16
Variable	Length Variable name	Variable name; Byte type of direct variables only available (In other words, types of %MB / %PB / %DB/... available: supporting devices: P,N,L,K,T,C,D,N, F ) It displays block's start address. (Ex. %MB0, %PB0)
Number of Data	2	Data Size in byte whose Maximum value is 1400.(h0578)

Format name	Header	Instruction	Data type	Reserved area	Number of blocks	Variable length	Variable	Number of data
Code (Ex.)	...	h0054	h0014	h0000	h0001	h0006	%MB000	h0006

#### Notes

(1) Number of data means the number of data in byte unit (up to 1,400 bytes available).

#### 1) Data type

h0014 only can be used for the data type.

#### 2) Number of blocks

Definitely h0001 only can be used for the number of blocks.

#### 3) Variable length

It means the number of characters of the variable name which is available up to 16 characters, whose range is h0001 ~ h0010.

#### 4) Variable

It stands for variable's address to read actually. It shall be ASCII value within 16 characters. Others than figure, capital/small letter, '%' and '.' are not allowed for the variable name. Based on the PLC type, types of variables available to read continuously are as described below.

(3) Response format (For PLC's ACK Response)

- Read Response of Continuous Variable (PLC → MMI)

Item	Size(byte)	Description
Instruction	2	h0055 : Read Response
Data type	2	h0014 : Block Type
Reserved area	2	h0000 : Don't Care
Error status	2	Normal if it is 0, abnormal if not 0.
Error code	2	If Error State is abnormal, the lower byte is the error code.
Number of blocks		
Number of data	2	The Size of Data in byte.
Data	Data size	Data to read; up to 1400 bytes

Format name	Header	Instruction	Data type	Reserved area	Error status	Number of blocks	Number of data	Data
Code (Ex.)	...	h0055	h0014	h0000	h0000	h0001	h0006	h012345 6789AB

▷ Number of data means the number of bytes in Hexadecimal number.

(4) Response format (For PLC's NAK Response)

Format name	Header	Instruction	Data type	Reserved area	Error status	Error code (Hex 1 Byte)
Code (Ex.)	...	h0055	h0014	h0000	hFFFF	h21

Notes
1) Error code displays the type of error in 1 byte of Hexadecimal code. Refer to 'Error Code Table' for more details.

**8.2.3 Write Separated Direct Variable**

(1) Introduction

This function is used to directly specify the PLC device memory to write data on applicably to its memory data type. The data can be written on up to 16 separate device memories at a time.

(2) Request format (PC -> PLC)

■ Write Request of Individual Variable (MMI → PLC)

Item	Size(byte)	Description
Instruction	2	h0058: Write Request
Data type	2	Refer to Data Type table
Reserved area	2	h0000: Don't Care.
Number of blocks	2	Number of memory address to write; up to 16.
Variable length	2	The number of characters in the Direct variable; Max. 16
Variable name	Length of variable name	Direct variable only available
...	...	(Repeatedly as many as the number of blocks /up to 16)
Length of variable name	2	Length of direct variable. Max. 16
Variable name	Length of variable name	Direct variable only available
Data size	2	Byte size of Data
Data	Data size	Data to write
...	...	(Repeatedly as many as the number of blocks /up to 16)
Data size	2	Byte size of Data
Data	Data size	Data to write

Format name	Header	Instruction	Data type	Reserved area	Number of blocks	Variable length	Direct variable	..	Number of data	data	..
Code (Ex.)	..	h0058	h0002	h0000	h0001	h0006	%MW100	..	h0002	h1234	..

1 block (up to 16 blocks setting available repeatedly)

1) Number of blocks

Used to specify the number of blocks composed of '[Variable Length][Variable]'and '[Data Length] [Data]' in the frame whose Maximum number is 16(h10). Accordingly, the value of [Number of Blocks] shall be h01~ h10.

2) Variable length

It means the number of characters of the variable name which is available up to 16 characters, whose range is h01 ~ h10.

3) Variable

Input variable's address to read actually. It shall be ASCII value within 16 characters. Others than figure, capital/small letter, '%' and '.' are not allowed for the variable name.

Notes
<p>(1) Device data type of each block shall be surely identical. If the data type of the first block is Word, and that of the second is Double Word, an error may occur.</p> <p>(2) If data type is Bit, the data format will be one byte (HEX). In other words, if BIT value is 0, the data will be h00 and if the value is 1, the data will be h01.</p> <p>(3) When Bit write function is used, the address must be calculated in Bit unit. For example, to write a data in the hC (12<sup>th</sup>) bit of M172 word, the Bit address can be calculated as follow processing.</p> <p>Wrong Expression: %MX172C Right Expression: <math>172(\text{Word number}) \times 16 + 12(\text{Bit number}) = 2764</math> → %MX2764</p>

(3) Response format (For PLC's ACK Response)

Format name	Header	Instruction	Data type	Reserved area	Error status	Number of blocks
Code (Ex.)	...	h0059	h0002	h0000	h0000	h0001

1) Number of blocks

It is the number of blocks normally written.

(4) Response format (For NAK Response)

Format name	Header	Instruction	Data type	Reserved area	Error status	Error code (Hex 1 Byte)
Code (Ex.)	...	h0059	h0002	h0000	hFFFF (other than 0)	h21

Notes
<p>1) Error code is attached the type of error in 1 byte of Hexadecimal code. Refer to 'Error Codes Table' for more details.</p>

### 8.2.4 Write Continuous Direct Variable

#### (1) Introduction

This function is used to write the data on the directly defined PLC device memory continuously as many as specified from the address specified. However, byte type of variables is only available.

#### (2) Request format

##### ■ Write Request of Continuous Variable (MMI → PLC)

Item	Size(byte)	Description
Instruction	2	h0058 : Write Request
Data type	2	h0014 : Block Type
Reserved area	2	h0000 : Don't Care.
Number of blocks	2	It is fixed with h0001 for Continuous write.
Variable length	2	The number of characters in the variable field; Max. 16
Variable	Variable length	Variable name; Byte type of direct variables only available. (In other words, types of %MB / %PB / %DB/... available: supporting devices: P,N,L,K,T,C,D,N ) It displays block's start address. (Ex. %MB0, %PB0)
Data	Data size	Data to write, up to 1400 bytes

Format name	Header	Instruction	Data type	Reserved area	Number of blocks	Variable length	Variable	Number of data	Data
Code (Ex.)	...	h0058	h0014	h0000	h0001	h0006	%MB100	h0002	h1234

#### 1) Number of data

It means the number of data in byte unit. (up to 1,400(h0578) bytes available).

#### 2) Number of blocks

h0001 only can be used for Number of blocks field .

#### 3) Variable length

It is the number of characters of the variable which is available up to 16 characters, whose range is h01 ~ h10.

#### 4) Variable

It stands for variable's address to write actually. It shall be ASCII value within 16 characters. Others than figure, capital/small letter, '%' and '.' are not allowed for the variable name.

Based on the PLC type, types of variables available to write continuously are described in [Table 10.3.2].

#### Notes

- (1) Refer to applicable technical materials for respective device areas setting of XGT series.

(3) Response format (in case of PLC ACK response)

- Write Response of Continuous Variable (PLC → MMI)

Item	Size(byte)	Description
Instruction	2	h0059 : Write Response
Data type	2	h0014 : Block Type
Reserved area	2	h0000 : Don't Care.
Error status	2	Normal if it is 0, abnormal if not 0.
Number of blocks	2	If Error State abnormal, the lower Byte is error code.
Error code		h0001: If Error State normal.

Format name	Header	Instruction	Data type	Reserved area	Error status	Number of blocks
Code (Ex.)	...	h0059	h0014	h0000	h0000	h0001

1) Data type

Available data type is byte (%MB,%IB,%QB).

2) Number of data

It means the number of bytes (Hexadecimal).

(4) Response format (in case of PLC NAK response)

Format name	Header	Instruction	Data type	Reserved area	Error status	Error code (Hex 1 Byte)
Code (Ex.)	....	h0059	h0014	h0000	hFFFF	h21

1) Error code

Error code is attached the type of error in 1 byte of Hexadecimal code.

Refer to 'Error Codes Table' for more details.

### 8.2.5 Status Read Request (MMI -> PLC)

#### (1) Introduction

This service allows the user to use information and status of PLC through communication.

#### (2) Computer Request format

Item	Size(byte)	Description
Instruction	2	h00B0 : Status Request
Data type	2	h0000 : Don't Care
Reserved area	2	h0000 : Don't Care

#### (3) Response format (ACK Response from PLC)

Item	Size(byte)	Description
Instruction	2	h00B1 : Status Response
Data type	2	h0000 : Don't Care
Reserved area	2	h0000 : Don't Care
Error status	2	Normal if it is 0, abnormal if not 0.
Reserved area	2	h0000 : Don't Care
Data size	2	h0018
data	24	Status Data

#### (4) Data structure of XGT status

Item	Size (byte)	Byte position	Description
Slot Info	4	0	Slot information Bit00~Bit03: Local's slot information remotely connected with other station. Bit04~Bit07: Local's base information remotely connected with other station. Bit08~Bit11: Other station's slot information remotely connected. Bit12~Bit15: Other station's base information remotely connected. Bit16~Bit19: Slot information this module is installed on. Bit20~Bit23: Base information this module is installed on. Bit24~Bit31: Reserved
_CPU_TYPE	2	4	System type : Flag
_PADT_CNF	2	6	XG5000 connection status : Flag
_SYS_STATE	4	8	PLC mode and operation status : Flag
_CNF_ER	4	12	System error (serious) : Flag
_CNF_WAR	4	16	System warning : Flag
_VER_NUM	2	20	OS version No. : Flag
Reserved	2	22	Reserved area

\* Refer to Description of flags below for more details on respective items.

(5) Description of flags

1) \_CPU\_TYPE

15Bit : XGK(1)/XGI(0), 15-Bit : Single, Redundancy master(0)/ Redundancy slave(1)

Single : h8000~hffff

hA001 : XGK-CPUH

hA002 : XGK-CPUS

2) \_VER\_NUM

hXYYY : xx.yy

3) \_SYS\_STATE

It displays operation mode and operation status information of the system (DWORD, F00~F01)

Variable	Type	Device	Function	Description
_RUN	Bit	F00000	RUN	CPU module's operation status in RUN.
_STOP	Bit	F00001	STOP	CPU module's operation status in STOP.
_ERROR	Bit	F00002	ERROR	CPU module's operation status in ERROR.
_DEBUG	Bit	F00003	DEBUG	CPU module's operation status in DEBUG.
_LOCAL_CON	Bit	F00004	Local control	Operation mode changeable only by mode key
_MODBUS_CON	Bit	F00005	Modbus mode On	During Modbus slave service.
_REMOTE_CON	Bit	F00006	Remote mode On	During Run in remote mode.
-	Bit	F00007	-	-
_RUN_EDIT_ST	Bit	F00008	Modification in progress during Run (program being downloaded)	Modified program standing by while modified during Run.
_RUN_EDIT_CHK	Bit	F00009	Modification in progress during Run (internally processed)	Modification during Run being processed Internally.
_RUN_EDIT_DONE	Bit	F0000A	Modification complete during run	Modification normally complete during run.
_RUN_EDIT_END	Bit	F0000B	Internal flag known when modification complete during run	Modification normally complete during run.
_CMOD_KEY	Bit	F0000C	Operation mode change cause	Operation mode changed by key.
_CMOD_LPADT	Bit	F0000D	Operation mode change cause	Operation mode changed by local PADT.
_CMOD_RPADT	Bit	F0000E	Operation mode change cause	Operation mode changed by remote PADT.
_CMOD_RLINK	Bit	F0000F	Operation mode change cause	Operation mode changed by remote communication module.
_FORCE_IN	Bit	F00010	Compulsory input	Compulsory On/Off being executed for input contact.
_FORCE_OUT	Bit	F00011	Compulsory output	Compulsory On/Off being executed for output contact.

## Chapter 8 Dedicated Protocol Communication

Variable	Type	Device	Function	Description
_SKIP_ON	Bit	F00012	I/O skip being executed	Specified I/O module existent to stop error check and data refresh.
_EMASK_ON	Bit	F00013	Error mask being executed	Specified I/O module existent to speedily carry out the operation even if a defect occurred.
_MON_ON	Bit	F00014	Being monitored	External monitor in progress for programs and Variables.
_USTOP_ON	Bit	F00015	Stop by stop function	Stopped by stop function after scan closed during RUN mode operation.
_ESTOP_ON	Bit	F00016	Stop by ESTOP function	Immediately stopped by ESTOP function during RUN mode operation.
_CONPILE_MODE	Bit	F00017	Compiling	Compile being performed.
_INIT_RUN	Bit	F00018	Initializing	Initialization task being performed.
-	Bit	F00019	-	-
-	Bit	F0001A	-	-
-	Bit	F0001B	-	-
_PB1	Bit	F0001C	Program code 1	No.1 program code being executed.
_PB2	Bit	F0001D	Program code 2	No.2 program code being executed.
_CB1	Bit	F0001E	Compile code 1	No.1 compile code being executed.
_CB2	Bit	F0001F	Compile code 2	No.2 compile code being executed.

#### 4) \_CNF\_ER

It displays the error flags related with the operation stop errors.

Variable	Type	Device	Function	Description
_CPU_ER	Bit	F00020	CPU configuration Error	Normal operation unavailable due to CPU module' error found by self-diagnosis.
_IO_TYER	Bit	F00021	Module type discordant Error	Different configuration between each slot's I/O configuration parameters and actually installed module.
_IO_DEER	Bit	F00022	Module installation error	If each slot's module configuration changes during Run, it will be detected and displayed.
_FUSE_ER	Bit	F00023	Fuse blown error	If fuse is blown on the module among each slot's modules, it will be detected and displayed.
_IO_RWER	Bit	F00024	I/O module Read/Write error	Displayed if normal Read/write of I/O module among each slot's modules is not available.
_IP_IFER	Bit	F00025	Special/communication module interface error	Displayed if normal interface is unavailable due to abnormal special or communication module among each slot's modules.
_ANNUM_ER	Bit	F00026	Serious error detected in external equipment	Displayed if serious error detected in external device by user program and recorded on ANC_ERR[n].

Variable	Type	Device	function	Description
-	Bit	F00027	-	-
_BPRM_ER	Bit	F00028	Basic parameters error	Displayed if basic parameters abnormal.
_IOPRM_ER	Bit	F00029	IO configuration parameters error	Displayed if I/O configuration parameters abnormal.
_SPPRM_ER	Bit	F0002A	Special module parameters error	Displayed if special module parameter abnormal.
_CPPRM_ER	Bit	F0002B	Communication module parameters error	Displayed if communication module parameter abnormal.
_PGM_ER	Bit	F0002C	Program error	Displayed if user program abnormal.
_CODE_ER	Bit	F0002D	Program code error	Displayed if an indecipherable instruction is met while uses program executed.
_SWDT_ER	Bit	F0002E	System watch-dog error	Displayed if System watch-dog exceeded.
_BASE_POWER_ER	Bit	F0002F	Power error	Displayed if base power abnormal.
_WDT_ER	Bit	F00030	Scan watch-dog	Displayed if program scan time exceeds scan watch-dog time specified with parameters.
-	-	F00031 F0003F	-	-

5) \_CNF\_WAR

It displays all the warning flags related with continuation of the operation (DWORD, F004~F005)

Variable	Type	Device	Function	Description
_RTC_ER	Bit	F00040	RTC data error	Displayed if RTC data abnormal.
_DBCK_ER	Bit	F00041	Data back-up error	Displays that normal (hot or) warm restart program unavailable due to damaged data memory, thus cold-restart executed, which will be available in initialization program. If the initialization program complete, it will be reset automatically.
_HBCK_ER	Bit	F00042	Hot restart unavailable	-
_ABSD_ER	Bit	F00043	Abnormal operation stopped	Displays that continuous operation not allowed with the synchronized data kept in scan unit when program stopped in the middle due to power-cut while program executed and then powered back, which is available in initialization program. If the initialization program complete, it will be reset automatically.

## Chapter 8 Dedicated Protocol Communication

Variable	Type	Device	Function	Description
_TASK_ER	Bit	F00044	Task impact	Displayed if identical tasks requested as duplicated when user program executed.
_BAT_ER	Bit	F00045	Battery error	Displayed if battery voltage for back-up of user program and data memory is less than specified.
_ANNUM_ER	Bit	F00046	Slight error detected in external equipment.	Displayed if slight error detected in external equipment by user program and recorded on ANC_WB[n].
_LOG_FULL	Bit	F00047	Log memory full warning	Displays PLC's log memory full.
_HS_WAR1	Bit	F00048	HS parameter 1 error	Representative flag used to display HS link unavailable by checking parameters of HS link if enabled, which shall be reset if HS link disenabled.
_HS_WAR2	Bit	F00049	HS parameter 2 error	
_HS_WAR3	Bit	F0004A	HS parameter 3 error	
_HS_WAR4	Bit	F0004B	HS parameter 4 error	
_HS_WAR5	Bit	F0004C	HS parameter 5 error	
_HS_WAR6	Bit	F0004D	HS parameter 6 error	
_HS_WAR7	Bit	F0004E	HS parameter 7 error	
_HS_WAR8	Bit	F0004F	HS parameter 8 error	
_HS_WAR9	Bit	F00050	HS parameter 9 error	
_HS_WAR10	Bit	F00051	HS parameter 10 error	
_HS_WAR11	Bit	F00052	HS parameter 11 error	
_HS_WAR12	Bit	F00053	HS parameter 12 error	
_P2P_WAR1	Bit	F00054	P2P parameter 1 error	Representative flag used to display P2P unavailable by checking parameters of each P2P if enabled, which shall be reset if P2P disenabled.
_P2P_WAR2	Bit	F00055	P2P parameter 2 error	
_P2P_WAR3	Bit	F00056	P2P parameter 3 error	
_P2P_WAR4	Bit	F00057	P2P parameter 4 error	
_P2P_WAR5	Bit	F00058	P2P parameter 5 error	
_P2P_WAR6	Bit	F00059	P2P parameter 6 error	
_P2P_WAR7	-	F0005A	P2P parameter 7 error	
_P2P_WAR8	-	F0005B	P2P parameter 8 error	
_Constant_ER	-	F0005C	Fixed cycle error	It will ON if the scan time is greater than 'Fixed Cycle' specified.
-	-	F0005D ~F0005F	-	-

## 8.3 Modbus/TCP Dedicated Server

This is used when it operates as the master of other device or higher PC (MMI) Modbus.

### 8.3.1 Driver setting

The screenshot shows the 'Standard Settings' dialog box with the 'Host Table Settings' tab selected. The 'TCP/IP Settings' section includes fields for Station No. (0), Media (Port1 and Port2 both set to AUTO(electric)), IP address (192.168.80.5), Subnet Mask (255.255.255.0), Gateway (192.168.80.1), and DNS Server (0.0.0.1). There are checkboxes for DHCP and Relay, and a field for 'No. of Dedicated Connections' set to 3. The 'Receive Time Out Settings' section has fields for Client (60 sec) and Server (15 sec). The 'Driver Setting' section has 'Server Mode' set to 'Modbus Server' and 'RAPIEnet Settings' set to 'Disable'. There are 'OK' and 'Cancel' buttons at the bottom.

[Fig. 8.3.1] Modbus TCP driver setting

The screenshot shows the 'Modbus Settings' dialog box. It contains four text input fields: 'Bit read area Address' (set to %MX0), 'Bit write area Address' (set to %MX0), 'Word read area Address' (set to %MW0), and 'Word write area Address' (set to %MW0). There are 'OK' and 'Cancel' buttons at the bottom.

[Fig. 8.3.2] Modbus TCP address

## Chapter 8 Dedicated Protocol Communication

Modbus function and the maximum number of response data that Modbus TCP driver supports are described in the table below. The correspondent master device shall make a request within the range specified in the table. For example, Bit Read Request is available up to 2000 bits, and Bit Write Request is up to 1600 bits.

Code	Description	Address	Response Size
01	Read Coil Status	hXXX	2000 Coils
02	Read Input Status	1XXXX	2000 Coils
03	Read Holding Registers	4XXXX	125 Registers
04	Read Input Registers	3XXXX	125 Registers
05	Force Single Coil	hXXX	1 Coil
06	Preset Single Register	4XXXX	1 Register
15	Force Multiple Coils	hXXX	1600 Coils
16	Preset Multiple Registers	4XXXX	100 Registers

[table 8.3.1] Modbus function code

Mapping of XG-T PLC memory is required for each function code's request.

Respective setting details are as follows;

Item	Description	Remarks
DI area address	XGT address applicable to digital input area	Bit address
DO area address	XGT address applicable to digital output area	Bit address
AI area address	XGT address applicable to analog input area	Word address
AO area address	XGT address applicable to digital output area	Word address

The address value specified in each item is the base address of the applicable area.

Fig 8.3.1 shows that DI area is assigned starting from PX0000 and that AO area is assigned starting from PW300.

The input value of the base address shall be within the effective areas of %M, P, etc. Since Modbus address is 1 ~ 9999 (decimal), the size of the bit I/O area will be  $9999/8 = 1249.875$  bytes. In addition, the size of the word I/O area will be  $9999*2 = 19998$  bytes.

If the user sets the base address of the bit output (hXXX) area to 0, Modbus bit area 00001 will be correspondent to 0<sup>th</sup> byte, 0<sup>th</sup> bit, and 00002 to 0<sup>th</sup> byte, 1<sup>st</sup> bit.

## Chapter 9 Remote Connection Service

### 9.1 Introduction

This function is used for programming, downloading of user program, program debugging, monitoring, etc in network system where PLCs are connected with each other via Ethernet by remote control without moving the physical connection status of XG5000. It is especially convenient for easy access to each device from a place without repositioning when network-connected devices are separated far. XG5000 remote connection service is available under the following Logical Path to attain its purpose.

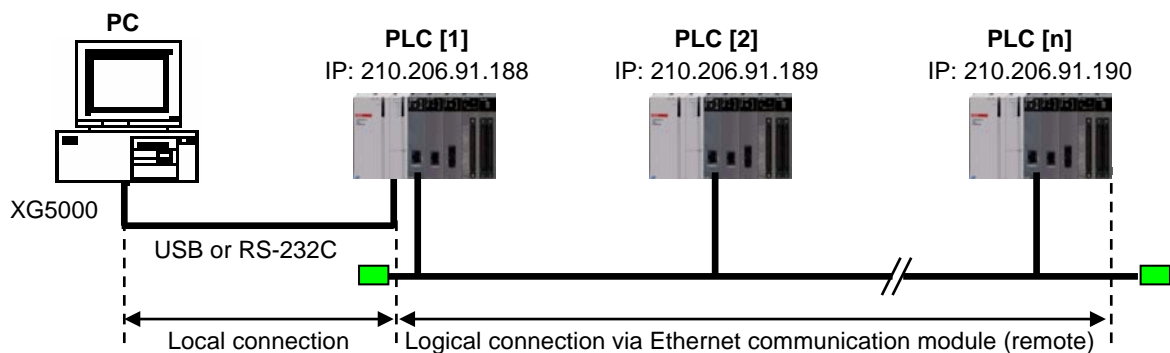

[Fig. 9.1.1] Ethernet network

A network is supposed where RS-232C cable is connected between PC in which XG5000 is installed and PLC #1 station, and PLC #1, PLC #2 and PLC #n are connected with each other via Ethernet in XG5000 of [Fig.9.1.1]. To access the contents of PLC #1 station in the figure above, Local connection is needed in XG5000's on-line menu. After finishing accessing the contents of PLC #1, disconnect the Local connection with 'Disconnect' menu. To access the PLC #n station, select PLC #n by setting the IP address of PLC #n and Base and Slot No. where FEnet module is installed in the PLC #1 station in the remote connection dialog box and connect. Then logical connection between XG5000 and PLC #n will be established via RS-232C and Ethernet. This status is identical to the status that RS-232C cable is connected between PC and PLC #n station and it is available to execute all functions of programming, downloading, debugging and monitoring as in PLC #1.

Also, if Ethernet module (LAN Card) is installed on PC where XG5000 is installed and connected to the identical network to PLC, remote stage 1 connection with PLC is available via Ethernet without local connection via RS-232C.

With the remote connection service of XG5000, easy access to PLC is possible even if the PLC is located at a far place. And re-programming without repositioning the PLC is possible when PLC is located at a place hard to reach.

## 9.2 Setting and Connection

All PLCs connected via XGT network are available to connect with each other by remote connection service. XG5000 remote connection is composed of stage 1 and stage 2 connections as described below.

The followings explains remote 1 and remote 2 connections.

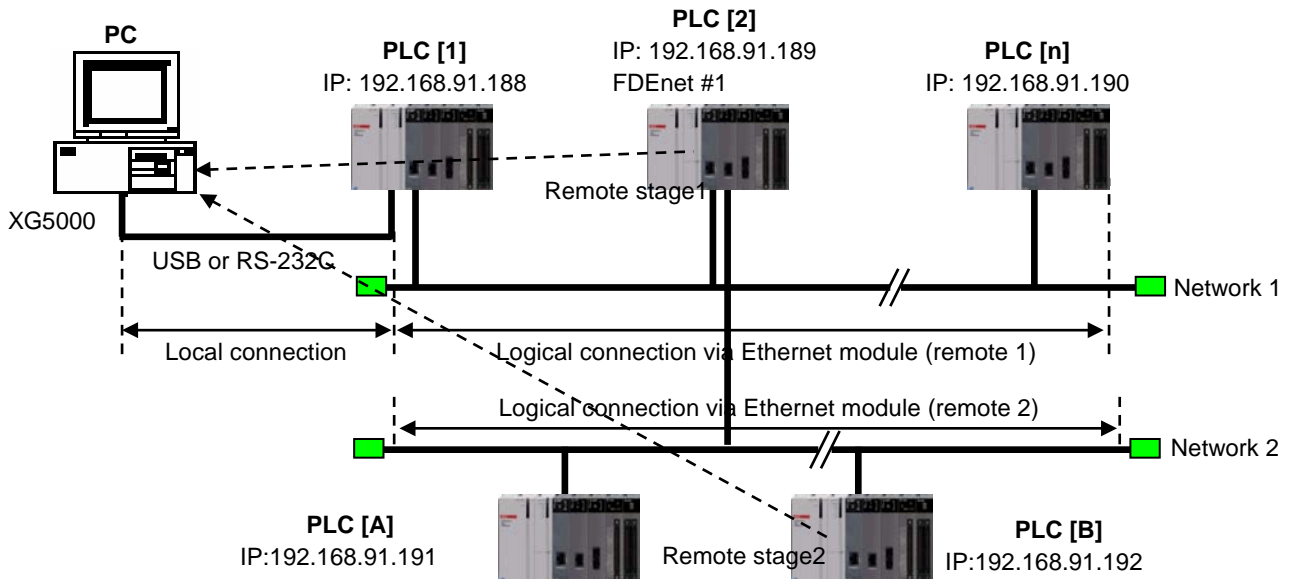

[Fig. 9.2.1] Remote connection

[Fig. 9.2.1] shows an example of network system composed of two networks.

### 9.2.1 Remote stage 1 connection (If RS-232C cable used)

For remote stage 1 connection, XG5000 shall be in off-line state.

Click [Online] -> [Connection settings]

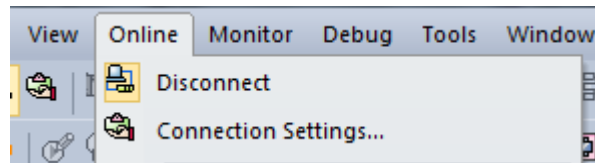

[Fig. 9.2.2] XG5000 remote connection option to select

#### (1) Connection type

It designates the connecting method for local connection. Local connection is applied with RS-232C used as in [Fig. 9.2.3]. Select the port used in PC for a communication port. The case that Ethernet is used for local connection will be described in the next section. Refer to user's manual of each communication module for the case with other connection types.

#### (2) Connection depth

Decide a PLC Connection stage of local, remote stage 1 or 2. Select remote stage 1 here.

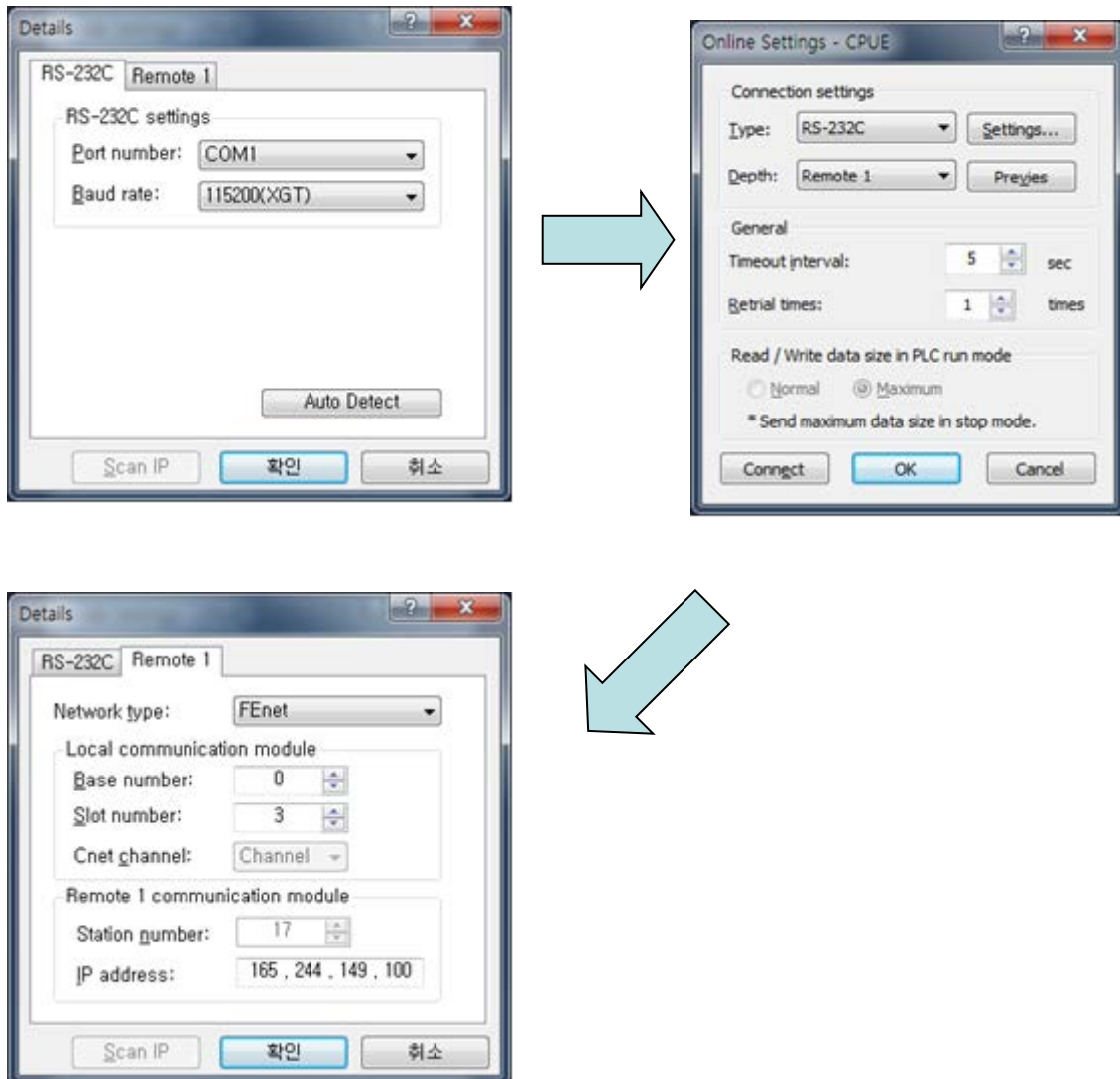

[Fig. 9.2.3] XG5000 remote stage 1 connection

(3) Network type

Select a network type for stage 1 connection among Rnet, Fdnet, Cnet, FEnet and FDEnet. XGL-FEnet is to be selected because stage 1 connection is applied through FEnet in [Fig. 9.2.3].

(4) Base No.

Specify the base No. where FEnet I/F module of PLC #1 for remote connection is installed.

(5) IP address

Specify the IP address of FENet I/F module installed in the PLC which will be connected with XG5000 in the network 1. Use the IP address of FENet module installed in PLC #2 station, 192.168.91.189 in [Fig. 9.2.3].

(6) Slot

It indicates the slot number where FENet module is installed in locally connected PLC via RS-232C. Select No.0 in [Fig. 9.2.3] since FENet installed on PLC #1 is on slot No.0.

Now click [OK] and then select [Connect] on the Online menu.

Since stage 1 connection-completed status is the logical connection status identical to the local connection with RS-232C cable is connected to the PLC, where all of the on-line menus are available. (Except that CPU type between PLC and presently open project is disagreeable)

### Notes

1) Precautions for remote connection

Prepare a program suitable for the correspondent CPU type to connect with remotely. If the CPU type is disagreeable between the two, limited functions only will be allowed, where program uploading/downloading and monitoring are not available.

### 9.2.2 Remote stage 2 connection (RS-232C cable is used for local connection)

For remote stage 2 connection, XG5000 shall be in off-line state.

Click [Online] -> [Connection settings] like [fig.9.2.2]

(1) Connection type

Select Local connection. [Fig. 9.2.4] shows that select RS-232C for Type and Remote 2 for Depth. The communication port choose using PC port. If use Ethernet, explain it in the next chapter. If use other communication module, Please refer to manual each communication modules.

(2) Connection depth

Select Remote 2

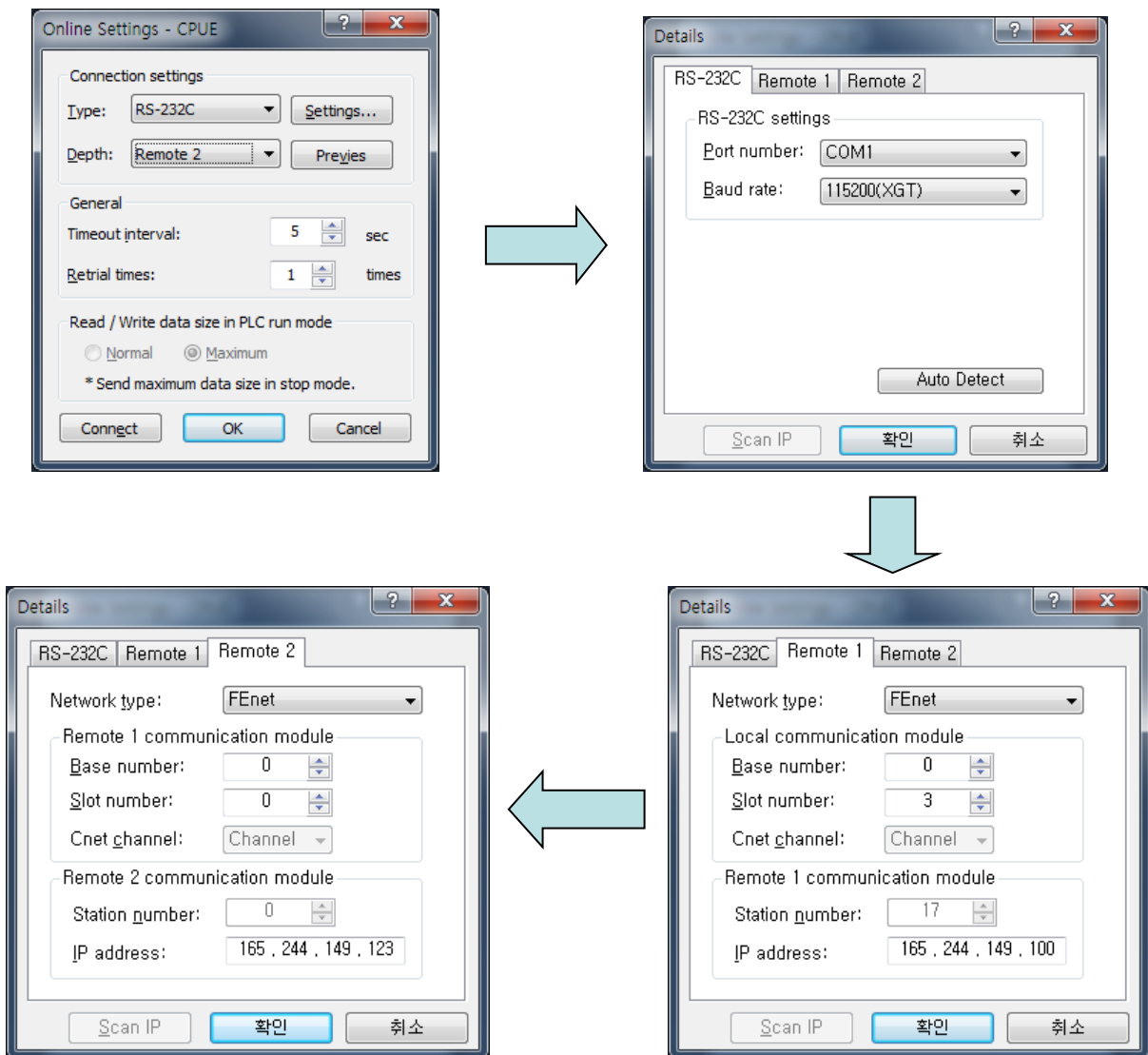

[Fig. 9.2.4] XG5000 remote stage 2 connection

Remote 2 only will be described below since the others are the same in the dialog box above.

(1) Setting of network type

Select a network type for remote stage 2 connection among XGT Rnet, Fdnet, Cnet, FEnet and FDEnet. Network types of stage 1 and stage 2 connections bear no relation to each other. XGL-FEnet is to be selected since stage 2 connection is with FEnet in [Fig. 9.2.4].

(2) IP address

Specify the IP address of FEnet I/F module installed in the PLC [B] which will be connected with XG5000 in the network 2. Use the IP address of FEnet module installed in PLC [B] station, 192.168.91.192 in [Fig. 9.2.4].

(3) Base and slot No.

Set the Base and Slot No. where FEnet module is installed in the PLC [2] which will be connected with stage 2 in the network 2.

Stage 2 connection-completed status as above is the logical connection status identical to the connection with RS-232C cable is connected to PLC [B], where all of the on-line menus are available.

### 9.2.3 Remote 1 connection directly from PC connected with Ethernet

Remote stage 1 connection via Ethernet without connecting RS-232C is available if a PC where XG5000 is operating is included in PLC Ethernet network.

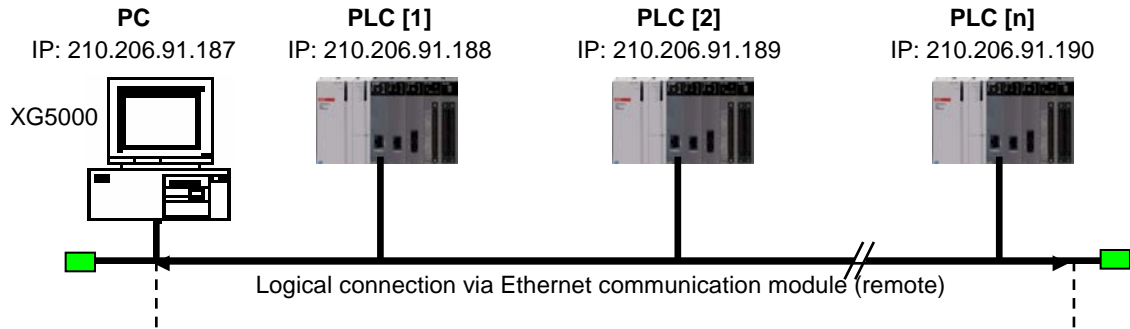

[Fig. 9.2.5] Remote stage 1 connection system through PC

[Fig. 9.2.5] shows the connection between PC and PLC via Ethernet, where connection to all PLCs on the network is available without RS-232C used in XG5000. In this case local connection is omissible and remote 1 connection is available with all PLCs.

Select 'Connection settings' on the Online menu and change the setting in the dialog box as specified below to establish remote stage 1 connection directly via Ethernet.

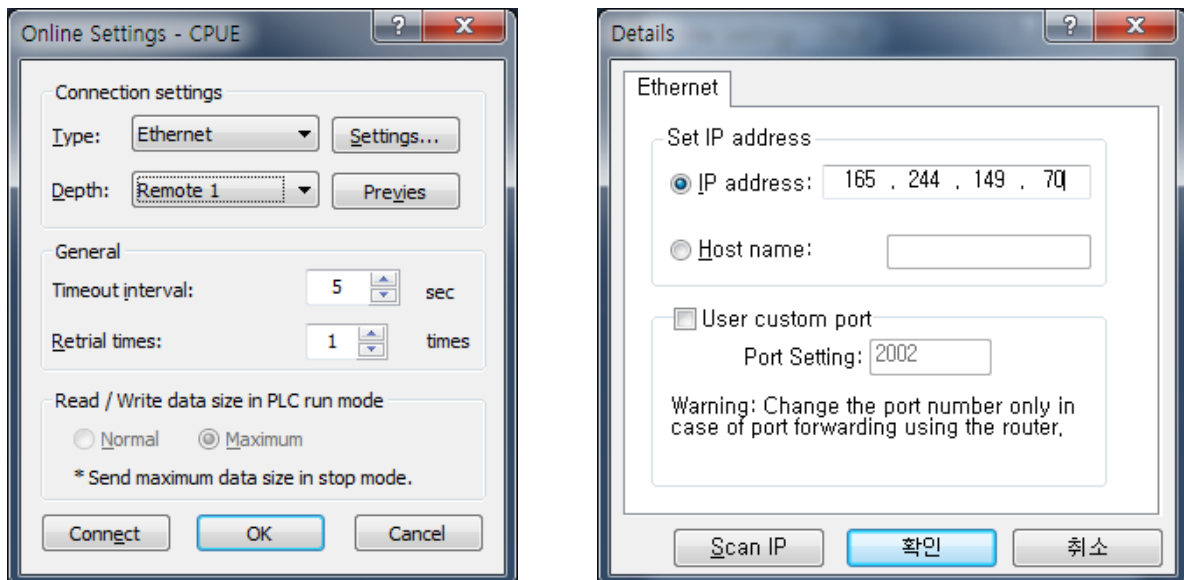

[Fig. 9.2.6] Remote 1 connection directly via Ethernet

(1) Connection type

Select an applicable type for connection. In the case of [Fig. 9.2.6], select Ethernet because the connection is established directly via Ethernet without application of RS-232C.

(2) Connection depth

Decide a PLC connection stage of remote stage 1 or 2. Select remote 1 here.

(3) IP address

Set the IP address of FEnet I/F module to connect to. Use IP address, 210.206.91.190 to connect to PLC [n] in [Fig. 9.2.6].

The rest procedures are the same as with RS-232C used. Now click [OK] and then select [Connect] on the Online menu.

It is accessible through Ethernet which the CPU module direct connection without Ethernet I/F module. CPU direct connection support high performance XGT-series.

(High performance XGT: Ethernet port internal CPU)

### 9.2.4 Remote 2 connection directly from PC connected with Ethernet

Remote stage 2 connection is available via Ethernet if a PC where XG5000 is operating is included in one PLC Ethernet network and one Ethernet is connected with other Ethernet network. The procedures are the same as in remote 1 connection and a setting example of 'Connection Setting' is as [Fig. 9.2.7].

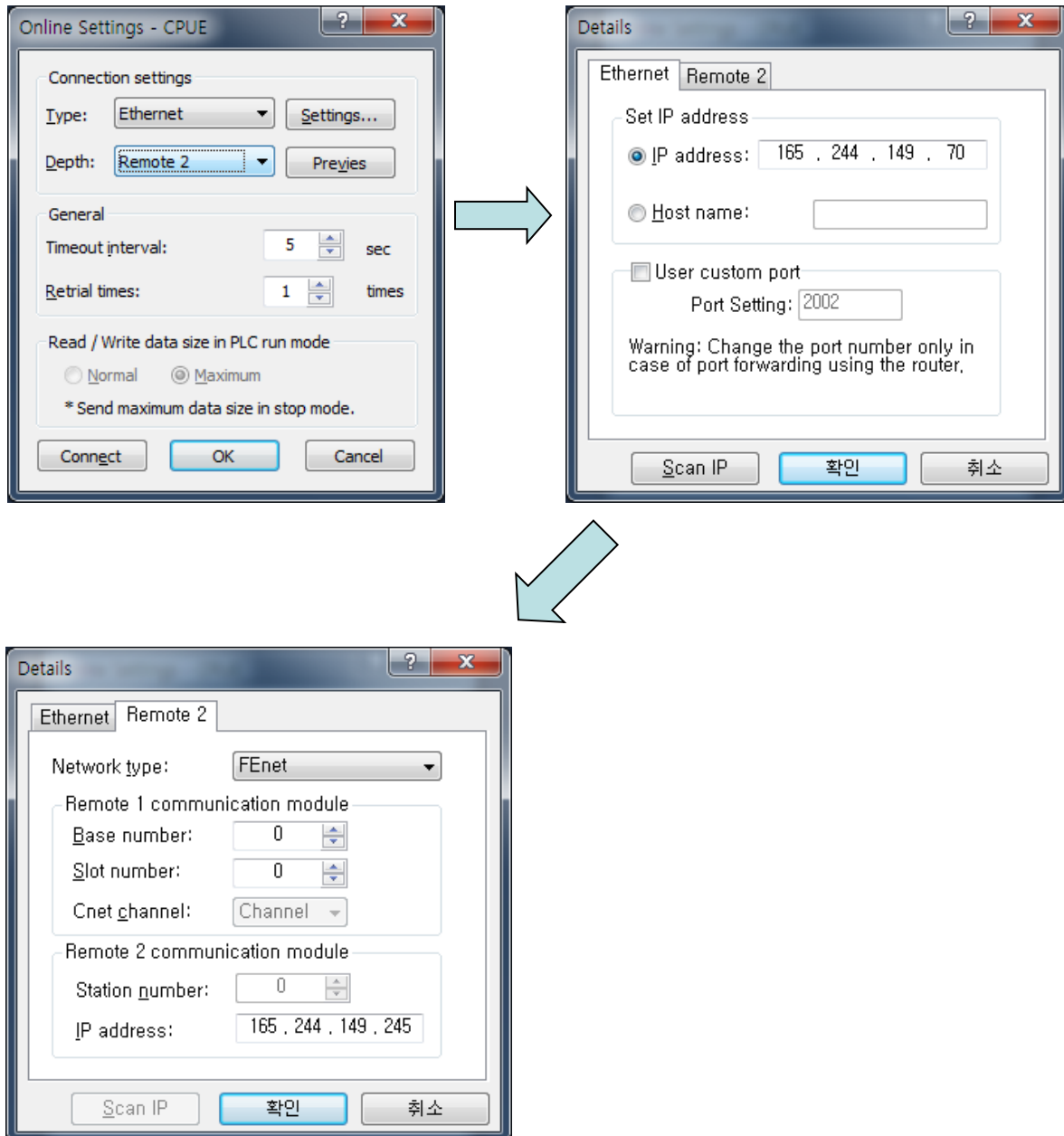

[Fig. 9.2.7] Remote 2 connection directly via Ethernet

### Notes

- (1) Precautions for operation with remote stage 1 & 2 connection
  - 1) The following menus are not available if the types between the project presently open in XG5000 and the CPU connected with stage 1 or 2 are not identical.
    - A) Write program and each parameter
    - B) Read program and each parameter
    - C) Monitor
    - D) Flash memory
    - E) Set Link Enable
    - F) I/O information
    - G) Compulsory I/O information
    - H) I/O SKIP
  - 2) Execute the remote connection with applicable project open of the station to connect to for XG5000 programming through remote stage 1 & 2 connections.
  - 3) Up to 2 stages only are available for the remote connection. More than that is not available for the remote connection.
- (2) In case of remote connection via XGR redundancy
  - 1) In case of remote connection via XGR redundancy, service is executed. Though you connect to Standby, connection route is Master CPU

## Chapter 10 Troubleshooting

This chapter is to describe various errors that may occur in system operation, their causes and actions to take against. Follow the procedures below to check for errors and error details in XGT FEnet I/F module. And take suitable actions against the abnormal module states surely through the troubleshooting in proper procedures. Discretionary repair or disassembly is not allowed. Because A/S does not have it, please be careful based on A/S rule.

### 10.1 Check through Communication Module LED

The status of the communication module can be checked through LED display.

#### 10.1.1 Abnormal operation display of XGL-EFMT/EFMF

The operation status can be checked through LED in front of Ethernet module.

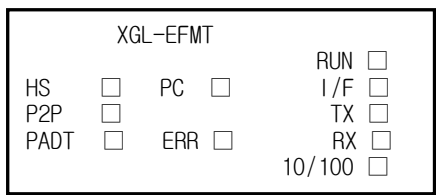

[Fig.10.1.1] LED structure of XGL-EFMT/EFMF module

LED	Error	Action
RUN	Turned off after FEnet powered on	1) Ethernet communication module incorrectly installed - check DC 5V power supply of power module. - check the communication module if correctly installed on the base. 2) Check if communication module is correctly perceived with XG5000.
I/F	LED on or off during normal communication	1) Check the operation state of CPU module. 2) Check the communication module if correctly installed on the base. 3) Check if module information is correctly perceived with XG5000 software.
P2P	Turned off during P2P command service	1) Check if the basic parameter is downloaded correctly. 2) Check if the function block/command is edited correctly. 3) Check if the media is connected correctly. 4) Check if 'Link Enable' is enabled.

LED	Error	Action
HS	Turned off during HS link service	1) Check if the basic parameter is downloaded correctly. 2) Check HS link setting if correct. 3) Check if 'Link Enable' is enabled.
PADT	Turned off during Remote connection service	1) Check if IP address for remote (PADT) connection is normal. 2) Check if remote connection of PADT is disconnected
PC	Turned off during dedicated service	1) Check if IP address for dedicated connection is correct. 2) Check if Host table is enabled. If Host table is enabled, check if the IP address of HMI(PC) is registered in the host table. 3) Check if connection is requested from MMI (PC) device.
ERR	Turned on during normal communication	1) Check if the basic parameter is downloaded correctly. 2) Check for any error in interface with CPU.

### 10.1.2 Abnormal operation display of XGL-EFMTB/EFMFB

The operation status can be checked through LED in front of Ethernet module.

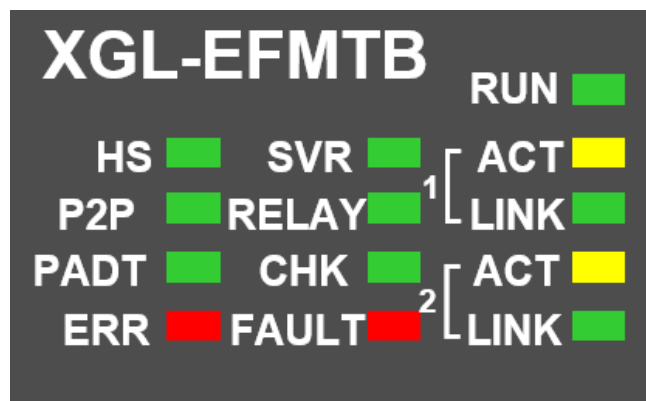

[Fig.10.1.2] LED structure of XGL-EFMTB/EFMFB module

LED	Error	Action
RUN	Turned off after FEnet powered on	1) Ethernet communication module incorrectly installed - check DC 5V power supply of power module. - check the communication module if correctly installed on the base. 2) Check if communication module is correctly perceived with XG5000.

## Chapter 10 Troubleshooting

P2P	Turned off during P2P command service	<ol style="list-style-type: none"> <li>1) Check if the basic parameter is downloaded correctly.</li> <li>2) Check if the function block/command is edited correctly.</li> <li>3) Check if the media is connected correctly.</li> <li>4) Check if 'Link Enable' is enabled.</li> </ol>
HS	Turned off during HS link service	<ol style="list-style-type: none"> <li>1) Check if the basic parameter is downloaded correctly.</li> <li>2) Check HS link setting if correct.</li> <li>3) Check if 'Link Enable' is enabled.</li> </ol>
PADT	Turned off during Remote connection service	<ol style="list-style-type: none"> <li>1) Check if IP address for remote (PADT) connection is normal.</li> <li>2) Check if remote connection of PADT is disconnected</li> </ol>
SVR	Turned off when Ethernet I/F module is used as dedicated service	<ol style="list-style-type: none"> <li>1) Check if IP address for dedicated connection is normal.</li> <li>2) Check if dedicated connection table is enable and in case enable, check if IP of HMI(PC) at dedicated connection table is registered.</li> <li>3) Check connection requirement is normal at HMI(PC)</li> </ol>
ERR	Turned on after Ethernet I/F module power on	<ol style="list-style-type: none"> <li>1) In case of major failure, turn on. If LED is on again after power reset, please contact service center.</li> </ol>
RELAY	Communication speed mismatch between relay ports	<p>If the Relay option of the basic parameter is checked, it turns ON when the media speed of Port 1 and Port 2 is the same and the frame can be relayed. Set the same communication speed between the two ports.</p> <p>In V6.0 or above, Relay LED will blink if the media speed is different between the two ports even if the Relay option is checked.</p> <p>* Relay function is not supported at 10Mbps, so if Relay option is checked at 10Mbps, Relay LED will be off.</p>
CHK	Flicker after turn on power	<ol style="list-style-type: none"> <li>1) Check IP collision or station number collision on the same network. (V5.0)</li> <li>2) Check whether same between set media type and set parameters.</li> <li>3) Check the RAPIEnet slave parameters for errors. (V6.0 or above)</li> <li>4) Check the RAPIEnet network for duplicated station number. (V6.0 or above)</li> </ol>
	Flicker during communication	<ol style="list-style-type: none"> <li>1) Make sure that the RAPIEnet network connection status is changed from Ring to Line.</li> </ol>
FAULT	Flicker during communication	<ol style="list-style-type: none"> <li>1) Check cable and Ethernet connector</li> <li>2) Check if there is an error in contents of communication.</li> </ol>
	LED is ON	<ol style="list-style-type: none"> <li>1) Check whether RAPIEnet station number and other RAPIEnet device are duplicated.</li> <li>2) Make sure that IP is duplicated on the same network.</li> </ol>
LNK	Turned off during communication	<ol style="list-style-type: none"> <li>1) Check connection status of cable(both stations)</li> </ol>

### 10.1.3 Abnormal operation display of XGL-EH5T

The operation status can be checked through LED in front of Ethernet module

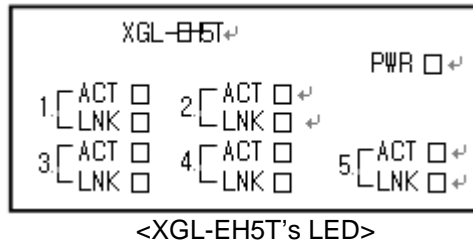

[Fig 10.1.3] LED structure of FEnet I/F module

This switch module (EH5T) doesn't need specific parameter setting and it uses power form Base. After turning on, if all LEDs except power LED flicker one time, switch module is normal.

LED	Error	Action
PWR	LED off after power on	1) Abnormal equipment of switch module - Check DC 5V power supply of power module. - check the communication module if correctly installed on the base.
ACT	ACT LED off	1) Check if cable is connected to port correctly. LED is off in the disconnection status 2) Check if data is communicated normally
LNK	LNK LED off	1) Check if cable is connected to port correctly. LED is off in the disconnection status

## 10.2 Module Check with XG5000

### 10.2.1 Error check in XG5000

XG5000 program can be used to monitor the communication module simply. Establish connection between PLC and a PC in which XG5000 is installed, and then select [Online] -> [PLC History], [PLC Error/Warning] in XG5000.

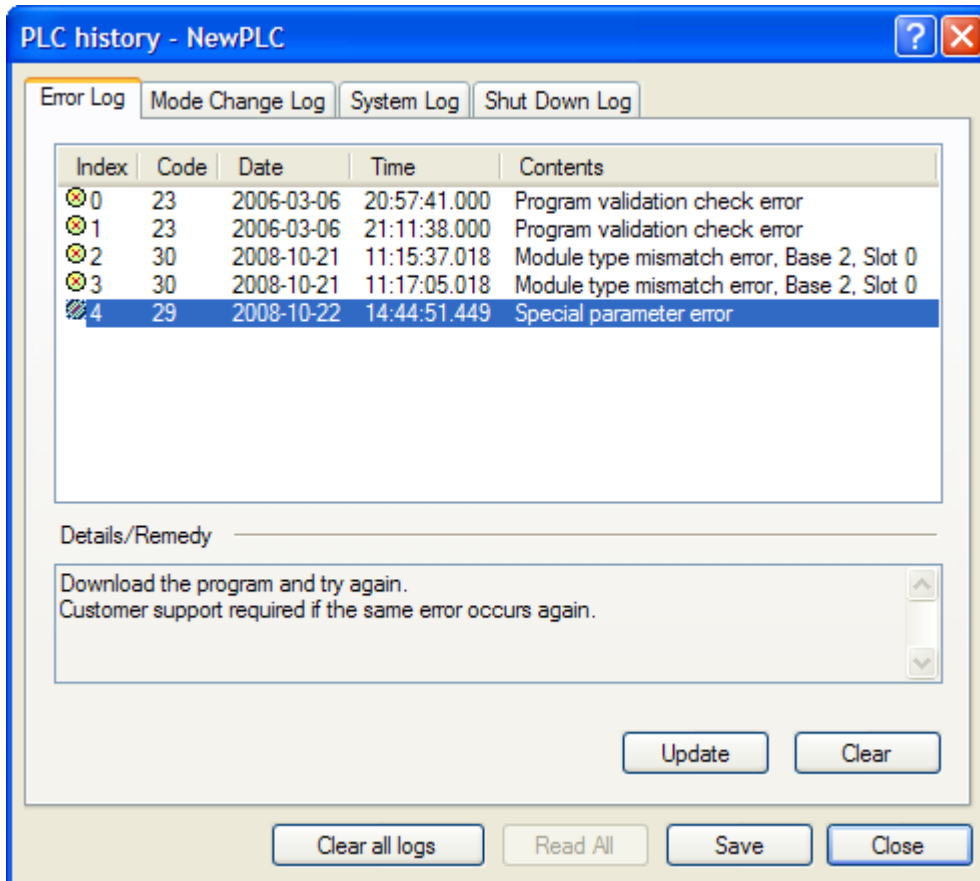

[Fig.10.2.1] PLC history

If a hardware error or a CPU interface error occurs on the module, LED of the communication module itself operates abnormally in general, whose status can be monitored simply through its dedicated program.

[Fig.10.2.1] shows error/warning information through PLC History on the XG5000 [Online] menu, which can be settled by referring to [Details and Actions].

10.2.2 Error code

It is brief and can monitor a communication module error through XG5000.  
 Click [Online] -> [Communication module setting] -> [System diagnosis]  
 Right click FEnet module -> [Status by service] -> [P2P Service]  
 When you use the E-mail service, please perform reference of E-mail error code.

Error Code	Description	What to do
0x0000	Normal	-
0x0001	P2P-Comm. error	1) (Modbus) Modbus registration error 2) (FEnet) Too many individual read/write request message block requested. Check the P2P block settings. 3) (Email) Email address error. Check the Email address.
0x0002	P2P-Comm. error	1) (Modbus) Modbus transmit size error. Check the P2P block settings 2) (FEnet) requested data type is not supported. Check the P2P block settings 3) Email) Email address book and message for transmission are not configured. Check the address and message settings
0x0003	P2P-Comm. error	1) (FEnet) requested device type is not supported. Check the P2P block settings 2) (FEnet) Connection with server is in progress. 3) (Cnet) Too many request message blocks are requested. Check P2P block settings 4) (Email) Can not connect to Email server. Check the IP address of Email server, ID and Password, or check the connected network status.
0x0004	P2P-Comm. error	1) (FEnet) Exceeded range of requested device type. Check the P2P block settings 2) (Modbus) received error message from server. Check the P2P block settings (address, size of data) 3) (Cnet) Check the size of variable from requested message
0x0005	P2P-Time out error	1) (XGT) No response within the response waiting time from the server stations. Check the communication settings 2) (FEnet) received error message from server because requested data over the maximum size(1400bytes). Check the P2P block settings. 3) (Email) Sending Email was failed. Check the network status.
0x0006	P2P-Disconnected	1) (XGT) The server does not respond. Check network settings or network connection status. 2) (FEnet) received error message from server because requested data over the maximum size(1400bytes). Check the P2P block settings.
0x0007	Dedicated Server-Data type error	1) (Cnet) requested unsupported data type from server CPU. Check the P2P block settings 2) (Email) The data downloaded with the status "Use E-mail" on E-mail setting window unchecked. Use after checking the "Use E-mail"
0x0008	Dedicated Server-Address	1) (Cnet) Address type error. Check the P2P block settings

## Chapter 10 Troubleshooting

	type error	
0x0010	P2P-XGT dedicated comm. or download error	1) (XGT) P2P parameter is now downloading. 2) (FEnet) Error in data type of request message. Check the P2P block setting
0x0011	P2P-Comm. error	1) (FEnet) Data type of request message and variable of setting are mismatch. Check the P2P block settings 2) (Cnet) Error in data of requested message. Check the data 3) (XGT) Check data type of the P2P block
0x0012	P2P-Comm. error	1) (FEnet) Wrong address format of request message. Check P2P block settings 2) (FEnet) Error occurs during the data transmission. Check the network connection status between the server.
0x0013	P2P-Request error	1) (XGT) Wrong P2P block request information
0x0015	P2P-Event transmit error	1) (XGT) Error occurred in internal sending logic
0x0016	P2P-Event receive error	1) (XGT) Error occurred in internal receiving logic
0x0017	P2P-Connection request error	1) (XGT) Can not connect to the server. Check the communication settings and network connection status.
0x0018	P2P-Exceeded no. of internal sending frame	1) (XGT) Exceeded number of internal sending frame. Check the communication settings and network connection status.
0x0051	P2P-Exceeded maximum number of connection	1) (XGT) The number of connections exceeded the maximum. Check the number of connections.
0x0062	P2P-Channel error	1) (XGT) Error in channel settings. Check the channel settings.
0x0075	P2P-Received XGT dedicated error reply message	1) (FEnet) The CompanyID of the header field of XGT dedicated service request message is invalid. Check settings.
0x0076	P2P-Received XGT dedicated error reply message	1) (FEnet) The size of the header field of XGT dedicated service request message is invalid. Check the settings.
0x0077	P2P-Received XGT dedicated error reply message	1) (FEnet) The checksum of the header field of XGT dedicated service request message is invalid. Check the settings.
0x0078	P2P-Received XGT dedicated error reply message	1) (FEnet) The command of the header field of XGT dedicated service request message is invalid. Check the settings.
0x0090	Dedicated Server-Monitor execution error	1) (Cnet) Error occurred in monitor execution register request. Check the settings
0x00F0	P2P-Buffer Error	1) (FEnet) Error occurred in internal buffer assignment.
0x0190	Dedicated Server-Monitor execution register number error	1) (Cnet) The monitor registration number exceeds the maximum value. Check the settings
0x0290	Dedicated Server-Monitor registration error	1) (Cnet) The monitor registration number exceeds the maximum value. Check the settings

0x1132	Dedicated Server-Device type error	1) (Cnet) requested accessing unsupported device area from server CPU. Check the settings
0x1232	Dedicated Server-Data size error	1) (Cnet) Exceeded maximum data size(120Byte) that can be requested. Check the settings
0x1234	Dedicated Server-Extra frame error	1) (Cnet) The specified data size of the server has been exceeded. Check the settings.
0x1332	Dedicated Server-Data type mismatch	1) (Cnet) Error in data type of single read/write function. Check the settings.
0x1432	Dedicated Server-HEX conversion error	1) (Cnet) Received a hex conversion error message from the server. Check the settings.
0x5D52	P2P-Email parameter download error	1) (Email) The data downloaded with the status "Use E-mail" on E-mail setting window unchecked. Use after checking the "Use E-mail"
0x7132	Dedicated Server-Excess of variable requested area error	1) (Cnet) The requested device range has been exceeded. Check the settings.
0xB001	P2P-Data type error	1) (Cnet) Check data type of the block.
0xB002	P2P-Driver type error	1) (Cnet) P2P driver type has not been set. Check if the basic parameter value is P2P and driver type of P2P channel settings.
0xB003	P2P-Command type error	1) (Cnet) Attempted P2P command is not supported by the block. Check the settings of P2P block.
0xB004	P2P-Block number error	1) (Cnet) Exceeded the configurable block number. Check the P2P parameter.
0xB005	P2P-Segment error	1) (Cnet) User defined frame parameter has an error. Check the parameter.
0xB006	P2P-Block size error	1) (Cnet) Check size setting of the block.
0xB007	P2P-Function type error	1) (Cnet) Used function code is not supported by the block. Check the settings of P2P block.
0xB008	P2P-Block station number setting error	1) (Cnet) Exceeded the maximum station number. Check the P2P parameter.
0xB025	P2P-Received incorrect response frame for the request	1) (Cnet) Incorrect response for requested frame. Check the settings of server.
0xB026	P2P-Received delayed response	1) (Cnet) Received delayed response frame. Check the Reception waiting time.
0xE001	P2P-Process error	1) (FEnet) There is a problem with the client's internal logic.
0xE004	P2P-Driver type error	1) (FEnet) P2P driver type is not configured. Check the driver type of P2P channel settings.
0xE005	P2P-Command type error	1) (FEnet) Attempted P2P command is not supported by the block. Check the settings of P2P block.
0xE006	P2P-Data type error	1) (FEnet) Check data type of the block.
0xE007	P2P-Request buffer full	1) (FEnet) Can not process the previous request data. Check the server connection status.
0xE020	P2P-User defined server transmit error	1) (User defined comm.) User defined server cannot send data unless it was connected to the others. Make connection to the other client first.

## Chapter 10 Troubleshooting

0xE022	P2P-Connecting	1) (FEnet/User defined comm.) The device is connecting to the server.
0xE024	P2P-XGT dedicated protocol transmit error	1) (FEnet) Error occurs during the XGT dedicated data transmission. Check the network connection status between the server.
0xE025	P2P-Modbus protocol transmit error	1) (Modbus) Error occurs during the Modbus data transmission. Check the network connection status between the server.
0xE026	P2P-User defined transmission error	1) (User defined comm.) Error occurs during the user defined data transmission. Check the network connection status between the server.
0xE027	P2P - Transmission error	1) (FEnet) Error occurred during the data transmission. Check the network status of the server.
0xE060	P2P-User defined protocol size error	1) (User defined comm.) The data size of user defined protocol is over the maximum(1024). Re-configure the data size.
0xE170	P2P-Email parameter download error	1) (Email) The data downloaded with the status "Use E-mail" on E-mail setting window unchecked. Use after checking the "Use E-mail".
0xE171	P2P-Email parameter setting error	1) (Email) The data downloaded with the status "Use E-mail" on E-mail setting window unchecked. Use after checking the "Use E-mail".
0xE172	P2P-Email address list or message download error	1) (Email) E-mail address book and message for transmission are not configured. Check the address and message setting on XG5000 and try again.
0xE173	P2P-Email receiver registration error	1) (Email) Error occurred during the registration of E-mail receivers.
0xE174	P2P-Email sender registration error	1) (Email) Error occurred during the registration of E-mail senders.
0xE175	P2P-Email initialization error	1) (Email) Error occurred during the initialization of E-mail driver.
0xE176	P2P-Email address error	1) (Email) Wrong type of Email address requested. Check the Email address and type(Group or individual).
0xE177	P2P-Email message type error	1) (Email) Wrong type of Email address requested. Check the type of Email message.
0xE178	P2P-Email server connection error	1) (Email) Can not connect to Email server. Check the IP address of Email server, ID and Password, or check the connected network status.
0xE179	P2P-Email sending error	1) (Email) Sending E-mail was failed. Check the network status.
0xFFD7	P2P-Data sending buffer full	1) (FEmet) Cannot process the requested data. Check the connection with server.
0xFFEB	P2P-Internal interlock error	1) (FEnet) There is a problem with internal logic.
0xFFFF	P2P-Error	1) (User defined comm.) Requested connection to the other device as user defined server, or error occurred on user defined transmit frame size(1024bytes) . Check the parameter again.

**10.3 Module Check through Error Codes**

Identify the error codes of abnormal operations described. Troubleshooting will show error details and actions to take against.

**10.3.1 Troubleshooting**

(1) Run LED Off : H/W error

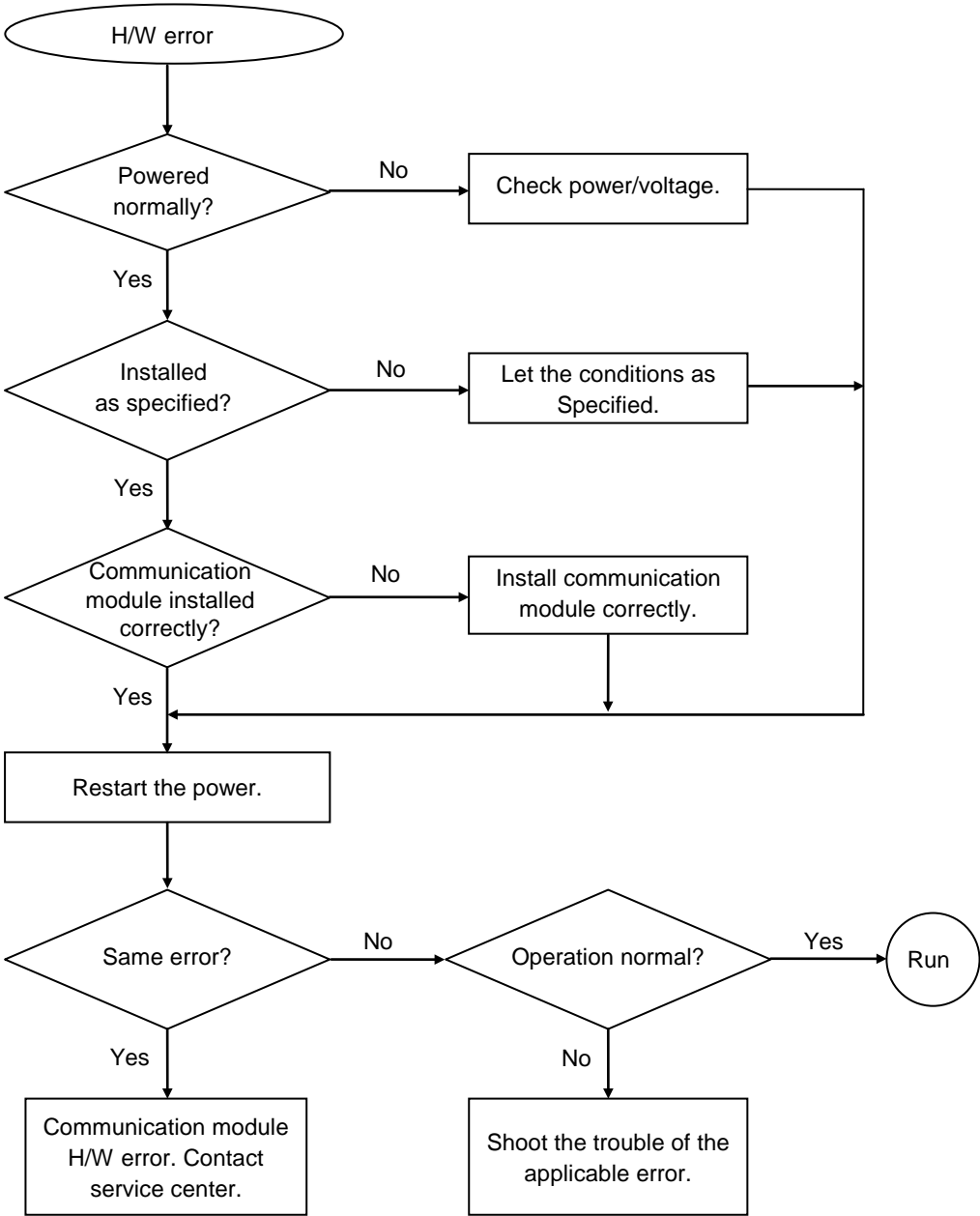

(2) I/F LED Off : Interface error

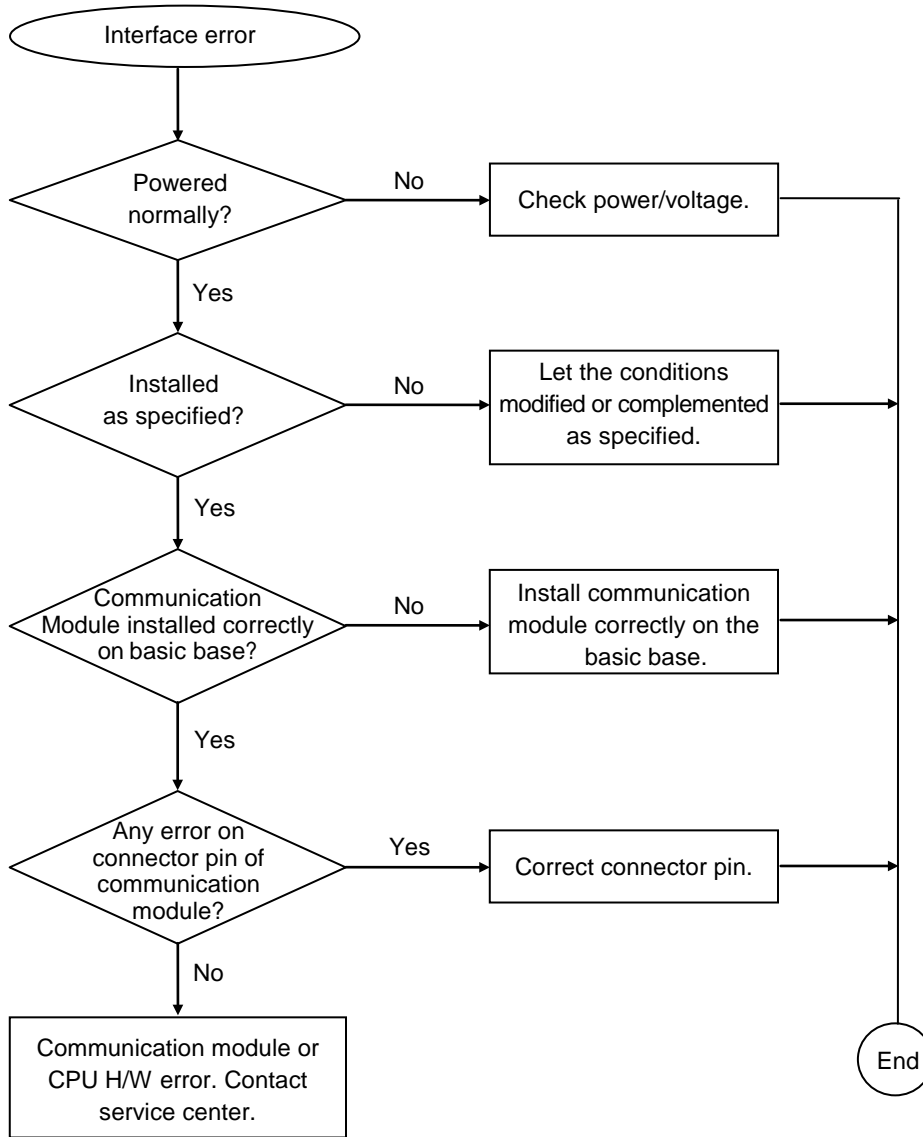

## 10.4 Communication error code

### 10.4.1 Status with a communication frame

It is an error code to reply error for the request of the communication using XGT dedicated communication header such as "LSIS-XGT" or "LGIS-GLOFA".  
It can check an error code in error code address.

Format Name	Header	Command	Data type	Reserved area	Error status	Error code (Hex 2 Byte)
Code(ex)	...	h'0055	h'0002	h'0000	h'FFFFFor h'00FF (not '0')	h'0004

```

0000 00 e0 91 02 00 21 00 e0 91 03 12 93 08 00 45 00  .....!... ..E.
0010 00 46 00 03 00 00 80 06 b8 96 c0 a8 00 5a c0 a8  .F..... ..Z..
0020 00 6e 07 d4 bb 52 01 91 8e e7 dc 6c 5c e3 50 18  .n...R... ..\..P.
0030 3e 80 3c a3 00 00 4c 53 49 53 2d 58 47 54 00 00  >.<...LS IS-XGT..
0040 01 01 a0 11 00 00 0a 00 04 1c 55 00 14 00 00 00  .....U.....
0050 ff 00 04 00  .....
    
```

[picture 10.4.1] Response frame for exceed an accessible address

Error code		Details
Decimal	Hex	
1	0x0001	When requesting Single Read/Write, the number of block is larger than 16
2	0x0002	Data type which is not X,B,W,D,L is received
3	0x0003	Device not serviced is requested (XGK : P, M, L, K, R, , XGI : I, Q, M..)
4	0x0004	Exceed the device area
5	0x0005	It can read or write maximum 1400bytes at once. That restriction is exceeded (Single block size)
6	0x0006	It can read or write maximum 1400bytes at once. That restriction is exceeded (Total size per block)
117	0x0075	First part of frame header is wrong at dedicated service ('LSIS-GLOFA')
118	0x0076	Length of frame header is wrong at dedicated service
119	0x0077	Checksum of frame header is wrong at dedicated service
120	0x0078	Instruction is wrong at dedicated service

#### Notes

- (1) If you check frame with frame capture tool, Data occurs byte swap.  
(Difference by endian)  
Ex) h'0054 ⇒ h'5400

## Chapter 11 Compliance with EMC Specifications

### 11.1 Requirements Complying with EMC Specifications

EMC Directions describe “Do not emit strong electromagnetic wave to the outside: Emission” and “Do not have an influence of electromagnetic wave from the outside: Immunity”, and the applicable products are requested to meet the directions. The chapter summarizes how to structure a system using XGT PLC to comply with the EMC directions. The description is the data summarized for the requirements and specifications of EMC regulation acquired by the company but it does not mean that every system manufactured according to the description meets the following specifications. The method and determination to comply with the EMC directions should be finally determined by the system manufacturer self.

#### 11.1.1 EMC specifications

The EMC specifications affecting the PLC are as follows.

Specification	Test items	Test details	Standard value
EN50081-2	EN55011 Radiated noise *2	Measure the wave emitted from a product.	30~230 MHz QP : 50 dB $\mu$ V/m * 1 230~1000 MHz QP : 57 dB $\mu$ V/m
	EN55011 conducted noise	Measure the noise that a product emits to the power line.	150~500 kHz QP : 79 dB Mean : 66 dB 500~230 MHz QP : 73 dB Mean : 60 dB
EN61131-2	EN61000-4- Electrostatic immunity	Immunity test allowing static electricity to the case of a device.	15 kV Air discharge 8 kV Contact discharge
	EN61000-4-4 Fast transient burst noise	Immunity test allowing a fast noise to power cable and signal cable.	Power line : 2 kV Digital I/O : 1 kV Analogue I/O, signal lines : 1 kV
	EN61000-4-3 Radiated field AM modulation	Immunity test injecting electric field to a product.	10Vm, 26~1000 MHz 80% AM modulation @ 1 kHz
	EN61000-4-12 Damped oscillatory wave immunity	Immunity test allowing attenuation vibration wave to power cable.	Power line : 1 kV Digital I/O(24V and higher) : 1 kV

[Table11.1.1] EMC Specifications

\* 1 : QP: Quasi Peak, Mean : average value

\* 2 : PLC is a type of open device(installed on another device) and to be installed in a panel.

For any applicable tests, the system is tested with the system installed in a panel.

### 11.1.2 Panel

The PLC is a kind of open device (installed on another device) and it should be installed in a panel. It is because the installation may prevent a person from suffering from an accident due to electric shock as the person contacts with the product (XGT PLC) and the panel can attenuate the noise generating from the PLC.

In case of XGT PLC, to restrict EMI emitted from a product, it should be installed in a metallic panel. The specifications of the metallic panel are as follows.

#### 1) Panel

The panel for PLC should be installed and manufactured as follows.

- (1) The panel should be made of SPCC (Cold Rolled Mild Steel)
- (2) The plate should be 1.6mm and thicker
- (3) The power supplied to the panel should be protected against surge by using insulated transformer.
- (4) The panel should be structured so that electric wave is not leaked outside. For instance, make the door as a box as presented below. The main frame should be also designed to be covered the door in order to restrict any radiating noise generated from the PLC.

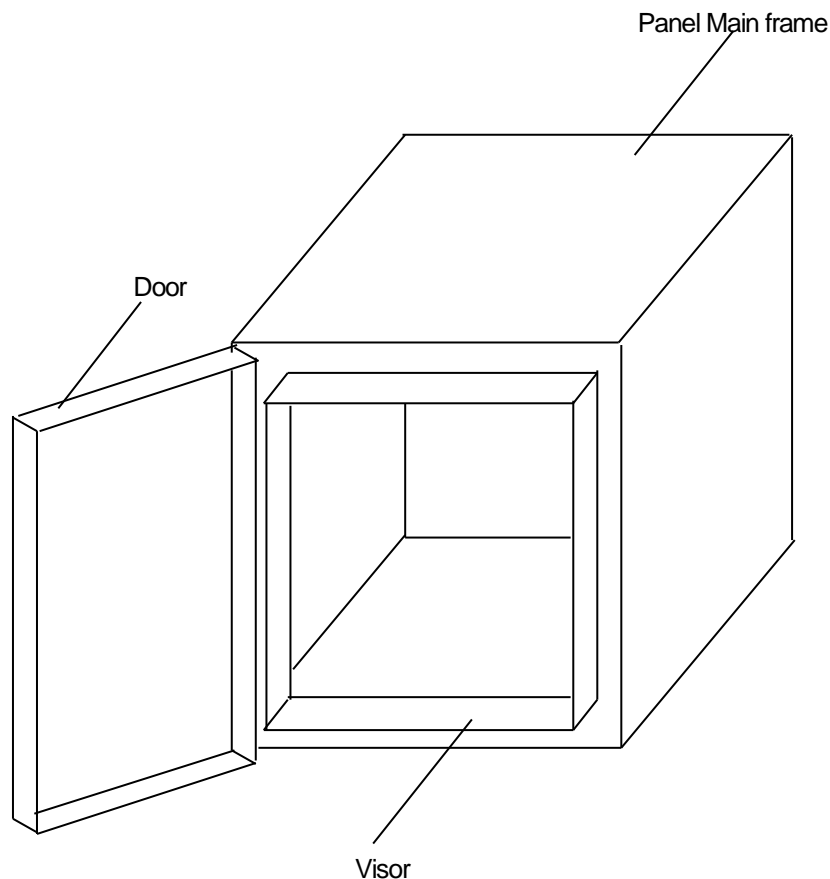

- (5) The inside plate of panel should have proper conductivity with a wide surface as possible by eliminating the plating of the bolt used to be mounted on the main frame in order to secure the electric contact with the frame.

2) Power cable and grounding cable

The grounding/power cable of PLC should be treated as follows.

- (1) The panel should be grounded with a thick wire() to secure a lower impedance even in high frequency.
- (2) LG(Line Ground) terminal and FG(Frame Ground) terminal functionally let the noise inside the PLC flow into the ground, so a wire of which impedance is low should be used.
- (3) Since the grounding cable itself may generate noise, thick and short wiring may prevent it serving as an antenna.

11.1.3 Cable

1) Extension cable treatment

The extension cable of XGT series is with fast electric signal. Therefore, high frequency noise wave is emitted from the extension cable. To comply with the CE specifications, please attach the ferrite core on the extension cable as presented in the figure.

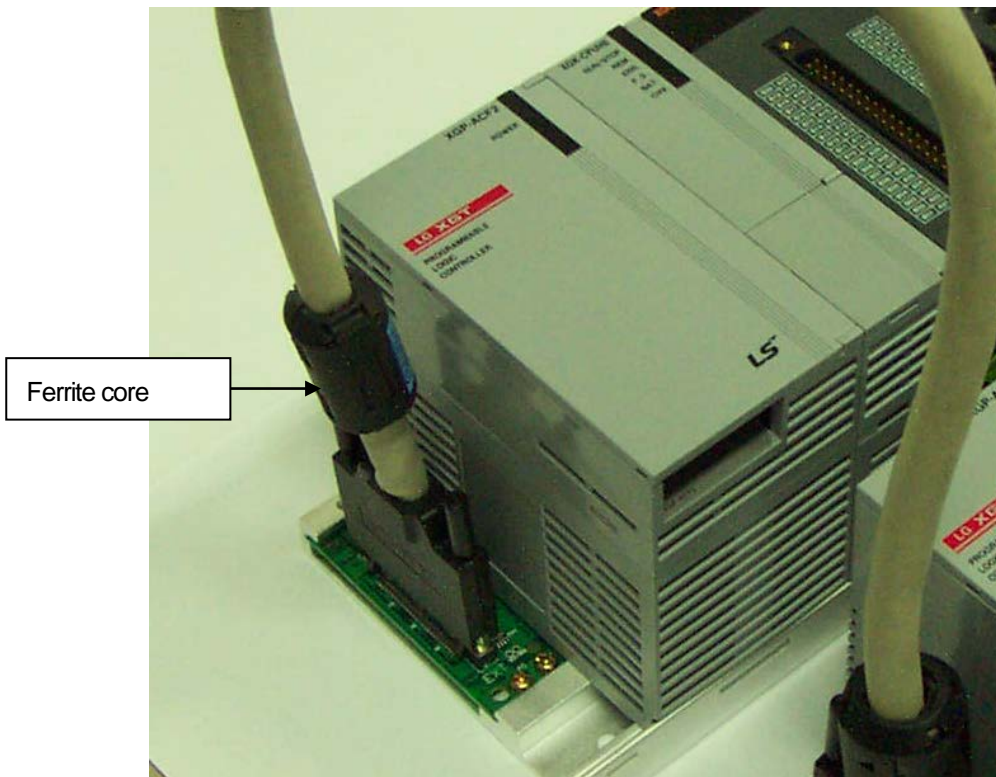

Mode	Manufacturer	Remarks
CU1330D	E Tech Electronics	-
ZCAT3035-1330	TDK	-

2) Fixing a cable in the panel

If the extension cable of XGT series is to be installed on the metallic panel, the cable should be 1cm and more away from the panel, preventing the direct contact.

The metallic plate of panel may shield noise from electromagnetic wave while it a cable as a noise source is close to the place, it can serve as an antenna. Every fast signal cable as well as the extension cable needs proper spacing from the panel.

### 11.2 Requirements Complying with Low Voltage Direction

The low voltage direction requires a device that operates with AC50~1000V, DC 75 ~ 1500V to have proper safety. The followings summarize the cautions for installing and wiring PLC of the XGT series to comply with the low voltage directions. The description is the data based on the applicable requirements and specifications as far as we know but it does not mean that every system manufactured according to the description meets the following specifications. The method and determination to comply with the EMC directions should be finally determined by the system manufacturer self.

#### 11.2.1 Specifications applicable to XGT series

XGT series follow the EN6100-1(safety of the device used in measurement/control lab).

XGT series is developed in accordance with the above specifications, even for a module operating at the rated voltage higher than AC50V/DC75V.

#### 11.2.2 Selection of XGT series PLC

(1) Power module

The power module of which rated input voltage is AC110/220V may have dangerous voltage(higher than 42.4V peak) inside it, so any CE mark compliance product is insulated between the primary and the secondary.

(2) I/O module

The I/O module of which rated voltage is AC110/220V may have dangerous voltage(higher than 42.4V peak) inside it, so any CE mark compliance product is insulated between the primary and the secondary. The I/O module lower than DC24V is not applicable to the low voltage directions.

(3) CPU Module, Base unit

The modules use DC5V, 3.3V circuits, so they are not applicable to the low voltage directions.

(4) Special module, Communication module

The modules use the rated voltage less than DC 24V, so they are not applicable to the low voltage directions.

## Appendix

### A.1 XGT CPU Memory Device List

For up-to-date device list of each CPU, refer to relevant CPU user manual. The following contents are based on when this user manual is written.

#### A.1.1 Device of XGK CPU

It is the memory addresses of CPU for the data send/receive.

Device type	Range	Size(Word)	Read/Write
P	P0 - P2047	2048	R/W
M	M0 - M2047	2048	R/W
K	K0 - K2047	2048	R/W
F	F0 - F1023	1024	R
F	F1024 - F2047	1024	R/W
T	T0 - T2047	2048	R/W
C	C0 - C2047	2048	R/W
U	U00.00 - U7F.31	4096	R/W
Z	Z0 - Z127	128	R/W
L	L0 - L11263	11264	R/W
N	N0 - N21503	21504	R/W
D(CPUH)	D0 - D32767	32768	R/W
D(CPUS)	D0 - D19999	20000	R/W
R	R0 - R32767	32768	R/W
ZR	ZR0 -ZR65535	65536	R/W

## A.1.2 Device of XGI CPU

Device type		Size	Range	Reference	
memory	Symbolic variable area(A)	512K byte	%AW0~%AW262143	Max 256K byte can be set as retain-area	
	Input variable(I)	16K byte	%IW0.0.0 ~ %IW127.15.3	-	
	Output variable(Q)	16K byte	%QW0.0.0 ~ %QW127.15.3	-	
	Direct variable	M	256K byte	%MW0~%MW131071	Max 128K byte can be set as retain-area
		R	64K byte * 2 blocks	%RW0~%RW32767	64K byte per one block
		W	128K byte	%WW0~%WW65535	-
	Flag variable	F	4K byte	%FW0~%FW2047	System flag
		K	16K byte	%KW0~%KW8399	PID flag
		L	22K byte	%LW0~%LW11263	High Speed Link flag
		N	42K byte	%NW0~%NW25087	P2P flag
U		8K byte	%UW7.15.31	Analog refresh flag	

## A.1.3 Device of XGR CPU

Device type		Size	Range	Reference	
Memory	Input variable(I)	16KB	%IW0.0.0 ~ %IW127.15.3	-	
	Output variable(Q)	16KB	%QW0.0.0 ~ %QW127.15.3	-	
	Automatic variable(A)	512KB	%AW0~%AW262143	Max 256K byte can be set as retain-area	
	Direct variable	M	256KB	%MW0~%MW131071	Max 128K byte can be set as retain-area
		R	64KB * 2 blocks	%RW0~%RW32767	64K byte per one block
		W	128KB	%WW0~%WW65535	Same with R area
	Flag variable	F	4KB	%FW0~%FW2047	System flag
		K	18KB	%KW0~%KW8399	PID area (PID 256 loop)
		L	22KB	%LW0~%LW11263	HS link flag, P2P flag
		N	42KB	%NW0~%NW25087	P2P parameter (XG5000 setting)
U		32KB	%UW31.15.31	Analog refresh area ( 31 base, 16 slot, 32 channel )	

## A.2 Terminology

A.2 explains it for the general term of the FEnet I/F module. If you want more detailed contents, Please perform reference of an Ethernet specialized book.

### 1. IEEE 802.3

IEEE 802.3 specifies standards for CSMA/CD based Ethernet. Exactly it is a LAN based on CSMA/CD (Carrier Sense Multiple Access with Collision Detection) Ethernet designed by IEEE 802.3 group, which is classified into detailed projects as specified below;

A) IEEE P802.3 - 10G Base T study Group

B) IEEE P802.3ah - Ethernet in the First Mile Task Force

C) IEEE P802.3ak - 10G Base-CX4 Task Force

※ Ethernet and IEEE 802.3 are standardized at RFC894 and RFC1042 so each should process another frame.

### 2. ARP (Address Resolution Protocol)

Protocol to search for MAC address by means of correspondent IP address on the Ethernet LAN

### 3. Bridge

A device used to connect two networks so to be operated as one network. Bridge is used not only to connect two different types of networks but also to divide one big network into two small networks in order to increase the performance

### 4. Client

A user of the network service, or a computer or program (mainly the one requesting services) using other computer's resource.

### 5. CSMA/CD(Carrier Sense Multiple Access with Collision Detection)

Each client checks if there is any sign prior to transmission of data to the network (Carrier Sense) and then sends its data when the network is empty. At this time, all the clients have the equal right to send (Multiple Access). If two or more clients send data, collision may occur. The client who detects the collision tries to send again in a specific time.

### 6. DNS (Domain Name System)

A method used to convert alphabetic Domain Name on the Internet to its identical Internet number (namely, IP address)

### 7. Dot Address

Shows IP address of '100.100.100.100', where each figure is displayed in decimal with 1 byte occupied respectively for 4 bytes in total.

### 8. E-mail Address

The address of the user with login account for the specific machine connected via the Internet. Usually user's ID @ domain name (machine name) is assigned. In other words, it will be like hjjee@microsoft.com, where @ is called as 'at' displayed with shift+2 pressed on the keyboard. The letters at the back of @ are for the domain name of specific company (school, institute,..) connected with the Internet, and the letters in front of @ are for the user ID registered in the machine. The last letters of the domain name are for the highest level. USA generally uses the following abbreviation as specified below, and Korea uses .kr to stand for Korea. .com : usually for companies) / .edu : usually for educational organizations such as universities. / .ac(academy) is mostly used in Korea / .gov : for governmental organizations. For example, nasa.gov is for NASA (government) / .mil : military related sites. For example, af.mil is for USA air force (military) / .org : private organizations / .au : Australia / .uk : the United Kingdom / .ca : Canada / .kr : Korea / .jp : Japan / .fr : France / .tw : Taiwan, etc.

### 9. Ethernet

A representative LAN connection system (IEEE 802.3) developed by Xerox, Intel and DEC of America which can send about 10Mbps and use the packet of 1.5kB. Since Ethernet can allow various types of computers to be connected as one via the network, it has been called a pronoun of LAN as a universal standard with various products available, not limited to some specific companies.

### 10. FTP (File Transfer Protocol)

An application program used to transfer files between computers among application programs providing TCP/IP protocol. If an account is allowed to the computer to log in, fast log in the computer is available wherever the computer is so to copy files.

### 11. Gateway

Software/Hardware used to translate for two different protocols to work together, which is equivalent to the gateway necessary to exchange information with the different system.

### 12. Header

Part of the packet including self-station Number, correspondent station Number and error checking area.

### 13. HTML

Hypertext Markup Language, standard language of WWW. In other words, it is a language system to prepare Hypertext documents. The document made of HTML can be viewed through the web browser

### 14. HTTP

Hypertext Transfer Protocol, standard protocol of WWW. It is a protocol supporting the hypermedia system.

### 15. ICMP (Internet Control Message Protocol)

An extended protocol of IP address used to create error messages and test packets to control the Internet.

### 16. IP (Internet Protocol)

Protocol of network layers for the Internet

### 17. IP Address

Address of respective computers on the Internet made of figures binary of 32 bits (4 bytes) to distinguish the applicable machine on the Internet. Classified into 2 sections, network distinguishing address and host distinguishing address. The network address and the host address is respectively divided into class A, B and C based on the bits allotted. IP address since it shall be unique all over the world, shall be decided not optionally but as assigned by NIC(Network Information Center) of the applicable district when joining the Internet. In Korea, KRNIC(Korea Network Information Center) is in charge of this work. Ex.) 165.244.149.190

### 18. ISO (International Organization for Standardization)

A subsidiary organization of UN, establishing and managing the international standards.

### 19. LAN (Local Area Network)

Called also as local area communication network or district information communication network, which allows lots of computers to exchange data with each other as connected though communication cable within a limited area such as in an office or a building

### 20. MAC (Medium Access Control)

A method used to decide which device should use the network during given time on the broadcast network

### 21. Node

Each computer connected with the network is called Node

### 22. Packet

A package of data which is the basic unit used to send through the network. Usually the package is made of several tens or hundreds of bytes with the header attached in front to which its destination and other necessary information are added

### 23. PORT number

Used to classify the applications on TCP/UDP.

Ex.) 21/tcp : Telet

### 24. PPP (Point-to-Point Protocol)

Phone communication protocol which allows packet transmission in connecting with the Internet. In other words, normal phone cable and modem can be used for the computer to connect through TCP/IP with this most general Internet protocol.

Similar to SLIP, however with modern communication protocol factors such as error detection and data compression, it demonstrates more excellent performance than SLIP.

### 25. Protocol

Contains regulations related with mutual information transmission method between computers connected with each other through the network. The protocol may specify detailed interface between machines in Low level (for example, which bit/byte should go out through the line) or high level of message exchange regulations as files are transferred through the Internet.

### 26. Router

A device used to transfer the data packet between the networks. It sends the data packet to its final destination, waits if the network is congested, or decides which LAN is good to connect to at the LAN junction. Namely, it is a special computer/software used to control the two or more networks connected.

## 27. Server

The side which passively responds to the client's request and shares its resources.

## 28. TCP (Transmission Control Protocol)

A transport layer protocol for the Internet

- Data Tx/Rx through connection
- Multiplexing
- Transmission reliable
- Emergent data transmission supported

## 29. TCP/IP (Transmission Control Protocol/Internet Protocol)

Transmission protocol used for communication among different kinds of computers, which makes the communication available between general PC and medium host, IBM PC and MAC, and medium or large-sized different types of computer. It is also used as a general term for information transmission protocol between computer networks including FTP, Telnet, SMTP, etc. TCP divides data into packets to send through IP and the packets sent will be united back together through TCP.

## 30) Telnet

It means remote login via Internet. To login to remote host via TELNET, account of that host is necessary. But for some hosts providing public service, you can connect without account

## 31) Token Ring

As short-distance network using Token to connect to network having physical ring structure, one of the Node connection methods at network. If node sending data gets Token, then node gets right to send message packet. Realistically structured examples are IEEE 802.5, ProNet-1080 and FDDI. Terms called Token is used as IEEE 802.5

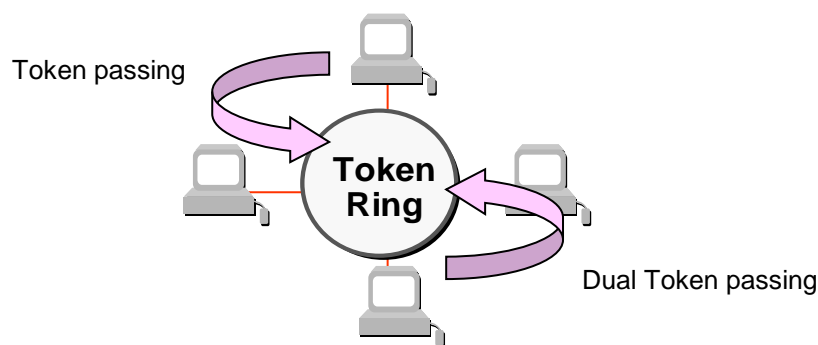

## 32) UDP(User Datagram Protocol)

A transport layer protocol for the Internet

- High speed communication because of communication without connection
- Multiplexing
- Lower reliability than TCP in transmission (Tough data doesn't arrive, it doesn't send data again)

### 33) Auto-Negotiation

Auto-negotiation is the process that Ethernet device changes information for the performance such as speed, mode (duplex)

1. The reason discovery that connection was refused.
2. Decide the performance that the network equipment has.
3. Change connection speed.

### 34) FDDI(Fiber Distributed Data Interface)

Based on optical cable, provides 100Mbps, Shared Media Network as Dual Ring method, Token Passing is done in two-way.

Max 200Km distance for entire network, Max 2Km between Nodes, Max 500 nodes. Generally, this used as Backbone Network.

### 35) Reset

This function is used to initialize the communication module with errors  
Use XG5000 to select [Online] -> [Reset/clear] -> [PLC reset]  
PLC is reset if do PLC reset.

## A.3 List of Flags

### A.3.1 List of Special Relays (F)

Device 1	Device 2	Type	Variable	Function	Description
F0000	-	DWORD	_SYS_STATE	Mode & Status	PLC mode & run status displayed.
-	F00000	BIT	_RUN	RUN	RUN status.
-	F00001	BIT	_STOP	STOP	STOP status.
-	F00002	BIT	_ERROR	ERROR	ERROR status.
-	F00003	BIT	_DEBUG	DEBUG	DEBUG status.
-	F00004	BIT	_LOCAL_CON	Local control	Local control mode.
-	F00005	BIT	_MODBUS_CON	Modbus mode	Modbus control mode.
-	F00006	BIT	_REMOTE_CON	Remote mode	Remote control mode.
-	F00008	BIT	_RUN_EDIT_ST	Modification during run	Program being downloaded during run.
-	F00009	BIT	_RUN_EDIT_CHK	Modification during run	Modification in progress during run.
-	F0000A	BIT	_RUN_EDIT_DONE	Modification complete during run	Modification complete during run.
-	F0000B	BIT	_RUN_EDIT_END	Modification complete during run	Modification complete during run.
-	F0000C	BIT	_CMOD_KEY	Run Mode	Run Mode changed by key.
-	F0000D	BIT	_CMOD_LPADT	Run Mode	Run Mode changed by local PADT.
-	F0000E	BIT	_CMOD_RPADT	Run Mode	Run Mode changed by remote PADT.
-	F0000F	BIT	_CMOD_RLINK	Run Mode	Run Mode changed by remote communication module.
-	F00010	BIT	_FORCE_IN	Compulsory input	Compulsory input status.
-	F00011	BIT	_FORCE_OUT	Compulsory output	Compulsory output status.
-	F00012	BIT	_SKIP_ON	I/O SKIP	I/O SKIP being executed.
-	F00013	BIT	_EMASK_ON	Error mask	Error mask being executed.
-	F00014	BIT	_MON_ON	Monitor	Monitor being executed.
-	F00015	BIT	_USTOP_ON	STOP	Stopped by STOP function
-	F00016	BIT	_ESTOP_ON	ESTOP	Stopped by ESTOP function.
-	F00017	BIT	_CONPILE_MODE	Compiling	Compile being performed.
-	F00018	BIT	_INIT_RUN	Initializing	Initialization task being performed.
-	F0001C	BIT	_PB1	Program code 1	Program code 1 selected.
-	F0001D	BIT	_PB2	Program code 2	Program code 2 selected.

## Appendix

Device 1	Device 2	Type	Variable	Function	Description
-	F0001E	BIT	_CB1	Compile code 1	Compile code 1 selected.
-	F0001F	BIT	_CB2	Compile code 2	Compile code 2 selected.
F0002	-	DWORD	_CNF_ER	System error	Serious error in system reported.
-	F00020	BIT	_CPU_ER	CPU error	CPU configuration error found.
-	F00021	BIT	_IO_TYER	Module type error	Module type not identical.
-	F00022	BIT	_IO_DEER	Module installation error	Module displaced.
-	F00023	BIT	_FUSE_ER	Fuse error	Fuse blown.
-	F00024	BIT	_IO_RWER	Module I/O error	Module I/O error found.
-	F00025	BIT	_IP_IFER	Module interface error	Error found in Special/communication module interface.
-	F00026	BIT	_ANNUM_ER	External equipment Error	Serious error detected in external equipment.
-	F00028	BIT	_BPRM_ER	Basic parameter	Basic parameter abnormal.
-	F00029	BIT	_IOPRM_ER	IO parameter	IO configuration parameter abnormal.
-	F0002A	BIT	_SPPRM_ER	Special module parameter	Special module parameter abnormal.
-	F0002B	BIT	_CPPRM_ER	Communication module parameter	Communication module parameter abnormal.
-	F0002C	BIT	_PGM_ER	Program error	Program error found.
-	F0002D	BIT	_CODE_ER	Code error	Program code error found.
-	F0002E	BIT	_SWDT_ER	System watch-dog	System watch-dog active.
-	F0002F	BIT	_BASE_POWER_ER	Power error	Base power abnormal.
-	F00030	BIT	_WDT_ER	Scan watch-dog	Scan watch-dog active.
F0004	-	DWORD	_CNF_WAR	System warning	Slight error in system reported.
-	F00040	BIT	_RTC_ER	RTC error	RTC data abnormal.
-	F00041	BIT	_DBCK_ER	Back-up error	Data back-up error found.
-	F00042	BIT	_HBCK_ER	Restart error	Hot restart unavailable.
-	F00043	BIT	_ABSD_ER	Run error stop	Stopped due to abnormal run.
-	F00044	BIT	_TASK_ER	Task impact	Task being impacted.
-	F00045	BIT	_BAT_ER	Battery error	Battery status abnormal.
-	F00046	BIT	_ANNUM_WAR	External equipment error	Slight error detected in external equipment.
-	F00047	BIT	_LOG_FULL	Memory full	Log memory full
-	F00048	BIT	_HS_WAR1	HS link 1	HS link – parameter 1 error
-	F00049	BIT	_HS_WAR2	HS link 2	HS link – parameter 2 error
-	F0004A	BIT	_HS_WAR3	HS link 3	HS link – parameter 3 error
-	F0004B	BIT	_HS_WAR4	HS link 4	HS link – parameter 4 error

## Appendix

Device 1	Device 2	Type	Variable	Function	Description
-	F0004C	BIT	_HS_WAR5	HS link 5	HS link – parameter 5 error
-	F0004D	BIT	_HS_WAR6	HS link 6	HS link – parameter 6 error
-	F0004E	BIT	_HS_WAR7	HS link 7	HS link – parameter 7 error
-	F0004F	BIT	_HS_WAR8	HS link 8	HS link – parameter 8 error
-	F00050	BIT	_HS_WAR9	HS link 9	HS link – parameter 9 error
-	F00051	BIT	_HS_WAR10	HS link 10	HS link – parameter 10 error
-	F00052	BIT	_HS_WAR11	HS link 11	HS link - parameter11 error
-	F00053	BIT	_HS_WAR12	HS link 12	HS link - parameter12 error
-	F00054	BIT	_P2P_WAR1	P2P parameter 1	P2P - parameter1 error
-	F00055	BIT	_P2P_WAR2	P2P parameter 2	P2P – parameter2 error
-	F00056	BIT	_P2P_WAR3	P2P parameter 3	P2P – parameter3 error
-	F00057	BIT	_P2P_WAR4	P2P parameter 4	P2P – parameter4 error
-	F00058	BIT	_P2P_WAR5	P2P parameter 5	P2P – parameter5 error
-	F00059	BIT	_P2P_WAR6	P2P parameter 6	P2P – parameter6 error
-	F0005A	BIT	_P2P_WAR7	P2P parameter 7	P2P – parameter7 error
-	F0005B	BIT	_P2P_WAR8	P2P parameter 8	P2P – parameter8 error
-	F0005C	BIT	_CONSTANT_ER	Fixed cycle error	Fixed cycle error
F0009	-	WORD	_USER_F	User contact point	Timer available for user.
-	F00090	BIT	_T20MS	20ms	CLOCK of 20ms cycle.
-	F00091	BIT	_T100MS	100ms	CLOCK of 100ms cycle.
-	F00092	BIT	_T200MS	200ms	CLOCK of 200ms cycle.
-	F00093	BIT	_T1S	1s	CLOCK of 1s cycle.
-	F00094	BIT	_T2S	2s	CLOCK of 2s cycle.
-	F00095	BIT	_T10S	10s	CLOCK of 10s cycle.
-	F00096	BIT	_T20S	20s	CLOCK of 20s cycle.
-	F00097	BIT	_T60S	60s	CLOCK of 60s cycle.
-	F00099	BIT	_ON	Always ON	Bit always ON.
-	F0009A	BIT	_OFF	Always OFF	Bit always OFF
-	F0009B	BIT	_1ON	1 scan ON	Bit only ON for the first scan.
-	F0009C	BIT	_1OFF	1 scan OFF	Bit only OFF for the first scan.
-	F0009D	BIT	_STOG	Reverse	Every scan reversed.
F0010	-	WORD	_USER_CLK	User CLOCK	CLOCK available to set by user.
-	F00100	BIT	_USR_CLK0	Repeat specific scan	ON/OFF CLOCK 0 for specific scan
-	F00101	BIT	_USR_CLK1	Repeat specific scan	ON/OFF CLOCK 1 for specific scan

## Appendix

Device 1	Device 2	Type	Variable	Function	Description
-	F00102	BIT	_USR_CLK2	Repeat specific scan	ON/OFF CLOCK 2 for specific scan
-	F00103	BIT	_USR_CLK3	Repeat specific scan	ON/OFF CLOCK 3 for specific scan
-	F00104	BIT	_USR_CLK4	Repeat specific scan	ON/OFF CLOCK 4 for specific scan
-	F00105	BIT	_USR_CLK5	Repeat specific scan	ON/OFF CLOCK 5 for specific scan
-	F00106	BIT	_USR_CLK6	Repeat specific scan	ON/OFF CLOCK 6 for specific scan
-	F00107	BIT	_USR_CLK7	Repeat specific scan	ON/OFF CLOCK 7 for specific scan
F0011	-	WORD	_LOGIC_RESULT	Logic result	Logic result displayed.
-	F00110	BIT	_LER	Calculation error	ON for 1 scan if calculation in error.
-	F00111	BIT	_ZERO	Zero flag	ON if calculation result is 0.
-	F00112	BIT	_CARRY	Carry flag	ON if Carry found during calculation.
-	F00113	BIT	_ALL_OFF	Whole output OFF	ON if all output OFF
-	F00115	BIT	_LER_LATCH	Calculation error latch	ON kept if calculation in error.
F0012	-	WORD	_CMP_RESULT	Compared result	Compared result displayed.
-	F00120	BIT	_LT	LT flag	ON if "less than"
-	F00121	BIT	_LTE	LTE flag	ON if "less than or equal"
-	F00122	BIT	_EQU	EQU flag	ON if "equal"
-	F00123	BIT	_GT	GT flag	ON if "greater than"
-	F00124	BIT	_GTE	GTE flag	ON if "greater than or equal"
-	F00125	BIT	_NEQ	NEQ flag	ON if "not equal"
F0013	-	WORD	_AC_F_CNT	Inspected power cut	Number of inspected power-cuts displayed.
F0014	-	WORD	_FALS_NUM	FALS No.	FALS No. displayed.
F0015	-	WORD	_PUTGET_ERR0	PUT/GET error 0	Main base PUT / GET error
F0016	-	WORD	_PUTGET_ERR1	PUT/GET error 1	Added base step 1 PUT / GET error
F0017	-	WORD	_PUTGET_ERR2	PUT/GET error 2	Added base step 2 PUT / GET error
F0018	-	WORD	_PUTGET_ERR3	PUT/GET error 3	Added base step 3 PUT / GET error
F0019	-	WORD	_PUTGET_ERR4	PUT/GET error 4	Added base step 4 PUT / GET error
F0020	-	WORD	_PUTGET_ERR5	PUT/GET error 5	Added base step 5 PUT / GET error
F0021	-	WORD	_PUTGET_ERR6	PUT/GET error 6	Added base step 6 PUT / GET error
F0022	-	WORD	_PUTGET_ERR7	PUT/GET error 7	Added base step 7 PUT / GET error
F0023	-	WORD	_PUTGET_NDR0	PUT/GET complete 0	Main base PUT / GET complete
F0024	-	WORD	_PUTGET_NDR1	PUT/GET complete 1	Added base step 1 PUT / GET complete
F0025	-	WORD	_PUTGET_NDR2	PUT/GET complete 2	Added base step 2 PUT / GET complete
F0026	-	WORD	_PUTGET_NDR3	PUT/GET complete 3	Added base step 3 PUT / GET complete
F0027	-	WORD	_PUTGET_NDR4	PUT/GET complete 4	Added base step 4 PUT / GET complete
F0028	-	WORD	_PUTGET_NDR5	PUT/GET complete 5	Added base step 5 PUT / GET complete

## Appendix

Device 1	Device 2	Type	Variable	Function	Description
F0029	-	WORD	_PUTGET_NDR6	PUT/GET complete 6	Added base step 6 PUT / GET complete
F0030	-	WORD	_PUTGET_NDR7	PUT/GET complete 7	Added base step 7 PUT / GET complete
F0044	-	WORD	_CPU_TYPE	CPU type	Information on CPU type displayed.
F0045	-	WORD	_CPU_VER	CPU version	CPU version displayed.
F0046	-	DWORD	_OS_VER	OS version	OS version displayed.
F0048	-	DWORD	_OS_DATE	OS date	OS released date displayed.
F0050	-	WORD	_SCAN_MAX	Max. scan time	Max. scan time displayed
F0051	-	WORD	_SCAN_MIN	Min. scan time	Min. scan time displayed
F0052	-	WORD	_SCAN_CUR	Present scan time	Present scan time displayed.
F0053	-	WORD	_MON_YEAR	Month / Year	PLC's time information (Month/Year)
F0054	-	WORD	_TIME_DAY	Hour / Date	PLC's time information (Hour/Date)
F0055	-	WORD	_SEC_MIN	Second / Minute	PLC's time information (Second/Minute)
F0056	-	WORD	_HUND_WK	100 years / Day	PLC's time information (100 years/Day)
F0057	-	WORD	_FPU_INFO	FPU calculation result	Floating decimal calculation result displayed.
-	F00570	BIT	_FPU_LFLAG_I	Incorrect error latch	Latched if in incorrect error.
-	F00571	BIT	_FPU_LFLAG_U	Underflow latch	Latched if underflow found.
-	F00572	BIT	_FPU_LFLAG_O	Overflow latch	Latched if overflow found.
-	F00573	BIT	_FPU_LFLAG_Z	Latch divided by 0	Latched if divided by 0.
-	F00574	BIT	_FPU_LFLAG_V	Invalid calculation latch	Latched if invalid calculation.
-	F0057A	BIT	_FPU_FLAG_I	Incorrect error	Reported if incorrect error found.
-	F0057B	BIT	_FPU_FLAG_U	Underflow	Reported if underflow found.
-	F0057C	BIT	_FPU_FLAG_O	Overflow	Reported if overflow found.
-	F0057D	BIT	_FPU_FLAG_Z	Division by 0	Reported if divided by 0.
-	F0057E	BIT	_FPU_FLAG_V	Invalid calculation	Reported if calculation invalid.
-	F0057F	BIT	_FPU_FLAG_E	Irregular value input	Reported if irregular value input.
F0058	-	DWORD	_ERR_STEP	Error step	Error step saved.
F0060	-	DWORD	_REF_COUNT	Refresh	Increased when module refresh executed.
F0062	-	DWORD	_REF_OK_CNT	Refresh OK	Increased if module refresh normal
F0064	-	DWORD	_REF_NG_CNT	Refresh NG	Increased if module refresh abnormal.
F0066	-	DWORD	_REF_LIM_CNT	Refresh LIMIT	Increased if module refresh abnormal (TIME OUT).
F0068	-	DWORD	_REF_ERR_CNT	Refresh ERROR	Increased if module refresh abnormal.
F0070	-	DWORD	_MOD_RD_ERR_CNT	Module READ ERROR	Increased if module reads 1 word abnormally.
F0072	-	DWORD	_MOD_WR_ERR_CNT	Module WRITE ERROR	Increased if module writes 1 word abnormally.

## Appendix

Device 1	Device 2	Type	Variable	Function	Description
F0074	-	DWORD	_CA_CNT	Block service	Increased if module's block data serviced
F0076	-	DWORD	_CA_LIM_CNT	Block service LIMIT	Increased if module's block data service abnormal.
F0078	-	DWORD	_CA_ERR_CNT	Block service ERROR	Increased if module's block data service abnormal.
F0080	-	DWORD	_BUF_FULL_CN T	Buffer FULL	Increased if CPU's internal buffer is FULL.
F0082	-	DWORD	_PUT_CNT	PUT count	Increased if PUT executed.
F0084	-	DWORD	_GET_CNT	GET count	Increased if GET executed.
F0086	-	DWORD	_KEY	Present key	Local key's present status displayed.
F0088	-	DWORD	_KEY_PREV	Previous key	Local key's previous status displayed.
F0090	-	WORD	_IO_TYER_N	Discordant slot	Slot number with discordant module type displayed.
F0091	-	WORD	_IO_DEER_N	Displaced slot	Slot number with displaced module displayed.
F0092	-	WORD	_FUSE_ER_N	Fuse blown slot	Slot number with fuse blown displayed.
F0093	-	WORD	_IO_RWER_N	RW error slot	Slot number with module Read/Write error displayed.
F0094	-	WORD	_IP_IFER_N	IF error slot	Slot number with module interface error displayed.
F0096	-	WORD	_IO_TYER0	Module type 0 error	Main base module type error.
F0097	-	WORD	_IO_TYER1	Module type 1 error	Added base step 1 module type error.
F0098	-	WORD	_IO_TYER2	Module type 2 error	Added base step 2 module type error.
F0099	-	WORD	_IO_TYER3	Module type 3 error	Added base step 3 module type error.
F0100	-	WORD	_IO_TYER4	Module type 4 error	Added base step 4 module type error.
F0101	-	WORD	_IO_TYER5	Module type 5 error	Added base step 5 module type error
F0102	-	WORD	_IO_TYER6	Module type 6 error	Added base step 6 module type error
F0103	-	WORD	_IO_TYER7	Module type 7 error	Added base step 7 module type error
F0104	-	WORD	_IO_DEER0	Module installation 0 error	Main base module installation error
F0105	-	WORD	_IO_DEER1	Module installation 1 error	Added base step 1 module installation error
F0106	-	WORD	_IO_DEER2	Module installation 2 error	Added base step 2 module installation error
F0107	-	WORD	_IO_DEER3	Module installation 3 error	Added base step 3 module installation error
F0108	-	WORD	_IO_DEER4	Module installation 4 error	Added base step 4 module installation error
F0109	-	WORD	_IO_DEER5	Module installation 5 error	Added base step 5 module installation error
F0110	-	WORD	_IO_DEER6	Module installation 6 error	Added base step 6 module installation error
F0111	-	WORD	_IO_DEER7	Module installation 7 error	Added base step 7 module installation error
F0112	-	WORD	_FUSE_ER0	Fuse blown 0 error	Main base Fuse blown error
F0113	-	WORD	_FUSE_ER1	Fuse blown 1 error	Added base step 1 Fuse blown error
F0114	-	WORD	_FUSE_ER2	Fuse blown 2 error	Added base step 2 Fuse blown error
F0115	-	WORD	_FUSE_ER3	Fuse blown 3 error	Added base step 3 Fuse blown error

## Appendix

Device 1	Device 2	Type	Variable	Function	Description
F0116	-	WORD	_FUSE_ER4	Fuse blown 4 error	Added base step 4 Fuse blown error
F0117	-	WORD	_FUSE_ER5	Fuse blown 5 error	Added base step 5 Fuse blown error
F0118	-	WORD	_FUSE_ER6	Fuse blown 6 error	Added base step 6 Fuse blown error
F0119	-	WORD	_FUSE_ER7	Fuse blown 7 error	Added base step 7 Fuse blown error
F0120	-	WORD	_IO_RWER0	Module RW 0 error	Main base module Read/Write error
F0121	-	WORD	_IO_RWER1	Module RW 1 error	Added base step 1 module Read/Write error
F0122	-	WORD	_IO_RWER2	Module RW 2 error	Added base step 2 module Read/Write error
F0123	-	WORD	_IO_RWER3	Module RW 3 error	Added base step 3 module Read/Write error
F0124	-	WORD	_IO_RWER4	Module RW 4 error	Added base step 4 module Read/Write error
F0125	-	WORD	_IO_RWER5	Module RW 5 error	Added base step 5 module Read/Write error
F0126	-	WORD	_IO_RWER6	Module RW 6 error	Added base step 6 module Read/Write error
F0127	-	WORD	_IO_RWER7	Module RW 7 error	Added base step 7 module Read/Write error
F0128	-	WORD	_IO_IFER_0	Module IF 0 error	Main base module interface error
F0129	-	WORD	_IO_IFER_1	Module IF 1 error	Added base step 1 module interface error
F0130	-	WORD	_IO_IFER_2	Module IF 2 error	Added base step 2 module interface error
F0131	-	WORD	_IO_IFER_3	Module IF 3 error	Added base step 3 module interface error
F0132	-	WORD	_IO_IFER_4	Module IF 4 error	Added base step 4 module interface error
F0133	-	WORD	_IO_IFER_5	Module IF 5 error	Added base step 5 module interface error
F0134	-	WORD	_IO_IFER_6	Module IF 6 error	Added base step 6 module interface error
F0135	-	WORD	_IO_IFER_7	Module IF 7 error	Added base step 7 module interface error
F0136	-	WORD	_RTC_DATE	RTC date	RTC's present date
F0137	-	WORD	_RTC_WEEK	RTC day	RTC's present day of the week
F0138	-	DWORD	_RTC_TOD	RTC time	RTC's present time (ms unit)
F0140	-	DWORD	_AC_FAIL_CNT	Power-cut times	Power-cut times saved.
F0142	-	DWORD	_ERR_HIS_CNT	Errors found	Number of found errors saved.
F0144	-	DWORD	_MOD_HIS_CNT	Mode conversion times	Mode conversion times saved.
F0146	-	DWORD	_SYS_HIS_CNT	History updated times	System's history updated times saved.

## Appendix

Device 1	Device 2	Type	Variable	Function	Description
F0148	-	DWORD	_LOG_ROTATE	Log rotate	Log rotate information saved.
F0150	-	WORD	_BASE_INFO0	Slot information 0	Main base slot information
F0151	-	WORD	_BASE_INFO1	Slot information 1	Added base step 1 slot information
F0152	-	WORD	_BASE_INFO2	Slot information 2	Added base step 2 slot information
F0153	-	WORD	_BASE_INFO3	Slot information 3	Added base step 3 slot information
F0154	-	WORD	_BASE_INFO4	Slot information 4	Added base step 4 slot information
F0155	-	WORD	_BASE_INFO5	Slot information 5	Added base step 5 slot information
F0156	-	WORD	_BASE_INFO6	Slot information 6	Added base step 6 slot information
F0157	-	WORD	_BASE_INFO7	Slot information 7	Added base step 7 slot information
F0158	-	WORD	_RBANK_NUM	Used block number	Presently used block number
F0159	-	WORD	_RBLOCK_STAT_E	Flash status	Flash block status
F0160	-	DWORD	_RBLOCK_RD_FLAG	Flash Read	ON when reading Flash N block data.
F0162	-	DWORD	_RBLOCK_WR_FLAG	Flash Write	ON when writing Flash N block data.
F0164	-	DWORD	_RBLOCK_ER_FLAG	Flash error	Error found during Flash N block service.
F1024	-	WORD	_USER_WRITE_F	Available contact	Contact point available in program
-	F10240	BIT	_RTC_WR	RTC RW	Data Write & Read in RTC
-	F10241	BIT	_SCAN_WR	Scan WR	Scan value initialization
-	F10242	BIT	_CHK_ANC_ERR	Detect external serious error	Detection of serious error in external equipment requested.
-	F10243	BIT	_CHK_ANC_WAR	Detect external slight error	Detection of slight error in external equipment requested.
F1025	-	WORD	_USER_STAUS_F	User contact point	User contact point
-	F10250	BIT	_INIT_DONE	Initialization complete	Initialization complete displayed.
F1026	-	WORD	_ANC_ERR	External serious error information	Serious error information in external equipment displayed.
F1027	-	WORD	_ANC_WAR	External slight error information	Slight error information in external equipment displayed.
F1034	-	WORD	_MON_YEAR_DT	Month / Year	Time information data (Month/Year)
F1035	-	WORD	_TIME_DAY_DT	Hour / Date	Time information data (Hour/Date)
F1036	-	WORD	_SEC_MIN_DT	Second / Minute	Time information data (Second/Minute)
F1037	-	WORD	_HUND_WK_DT	100 years / Day	Time information data (100 years/Day)

## A.3.2 List of Communication Relays (L)

### 1) Special register for data link

HS link No. 1 ~ 12

No.	Keyword	Type	Detail	Description
L000000	_HS1_RLINK K	Bit	HS link parameter No.1's all stations normally operates	Displays all stations normally operated as specified in HS link parameter, which will be On if 1. There is no error with all stations specified in parameter in RUN mode 2. All data block is in normal communication as specified in parameter. 3. The parameter specified in each station itself is in normal communication. Run_link will be kept On if once On until stopped by disabling link.
L000001	_HS1_LTRB L	Bit	After _HS1RLINK is ON, displays abnormal status	This flag will be On if the station specified in parameter and the data block's communication status are as described below with _HSmRLINK flag On. 1. when the station specified in parameter is not in RUN mode, 2. when the station specified in parameter is in error, 3. when data block's communication status specified in parameter is unstable,  The link trouble will be On if one of those conditions 1,2 and 3 above occurs. And if such a condition is back to normal, it will be Off.
L000020 ~ L00009F	_HS1_STATE[k] (k=000~127)	Bit Array	Displays HS link parameter No.1, Block No.k's general status	Displays the general status of the communication information for the specified parameter's respective data blocks.  HS1STATE[k]=HS1MOD[k]&_HS1TRX[k]&(~_HSmERR[k])
L000100 ~ L00017F	_HS1_MOD[k] (k=000~127)	Bit Array	HS link parameter No.1, Block No.k station's Run operation mode	Displays the operation mode of the station specified in parameter's data block k.
L000180 ~ L00025F	_HS1_TRX[k] (k=000~127)	Bit Array	Displays normal communication with HS link parameter No.1, Block No.k station	Displays the communication status of parameter's data block k to check if normal as specified.
L000260 ~ L00033F	_HS1_ERR[k]	Bit Array	HS link parameter No.1, Block No.k station's Run error mode	Displays the communication status of parameter's data block k to check for any error.
L000340 ~ L00041F	_HS1_SETBLOC[K]	Bit Array	Displays HS link parameter No.1, Block No.k setting	Displays the setting status of parameter's data block k.

[Table A.1] List of communication flags based on HS link number

## Appendix

---

HS link No.	L area address	Remarks
2	L000500~L00099F	Compared with HS link of 1 in [Table 1], other HS link station number's flag address will be simply calculated as follows; *Calculation formula: L area address = L000000 + 500 x (HS link No. - 1) In order to use HS link flag for program and monitoring, use the flag map registered in XG5000 for convenient application.
3	L001000~L00149F	
4	L001500~L00199F	
5	L002000~L00249F	
6	L002500~L00299F	
7	L003000~L00349F	
8	L003500~L00399F	
9	L004000~L00449F	
10	L004500~L00499F	
11	L005000~L00549F	

K as a block number is displayed through 8 words by 16 for 1 word for the information of 128 blocks from 000 to 127.

For example, block information of 16~31, 32~47, 48~63, 64~79, 80~95, 96~111, 112~127 will be displayed in L00011, L00012, L00013, L00014, L00015, L00016, L00017 from block 0 to block 15 for mode information (\_HS1MOD).

## Appendix

P2P parameters: 1~8, P2P block: 0~63

No.	Keyword	Type	Detail	Description
L006250	_P2P1_NDR00	Bit	P2P parameter No.1, block No.00 service is completed normally	P2P parameter No.1, block No.0 service is completed normally
L006251	_P2P1_ERR00	Bit	P2P parameter No.1, block No.00 service is completed abnormally	P2P parameter No.1, block No.0 service is completed abnormally
L00626	_P2P1_STATUS0 0	Word	Error code if P2P parameter No.1, block No.00 service is completed abnormally	Displays Error code if P2P parameter No.1, block No.0 service is completed abnormally
L00627	_P2P1_SVCCNT0 0	DWord	P2P parameter No.1, block No.00 service normal execution times	Displays P2P parameter No.1, block No.0 service normal execution times
L00629	_P2P1_ERRCNT0 0	DWord	P2P parameter No.1, block No.00 service abnormal execution times	Displays P2P parameter No.1, block No.0 service abnormal execution times
L006310	_P2P1_NDR01	Bit	P2P parameter No.1, block No.01 service is completed normally	P2P parameter No.1, block No.1 service is completed normally
L006311	_P2P1_ERR01	Bit	P2P parameter No.1, block No.01 service is completed abnormally	P2P parameter No.1, block No.1 service is completed abnormally
L00632	_P2P1_STATUS0 1	Word	Error code if P2P parameter No.1, block No.01 service is completed abnormally	Displays error code if P2P parameter No.1, block No.1 service is completed abnormally
L00633	_P2P1_SVCCNT0 1	DWord	P2P parameter No.1, block No.01 service normal execution times	Displays P2P parameter No.1, block No.1 service normal execution times
L00635	_P2P1_ERRCNT0 1	DWord	P2P parameter No.1, block No.01 service abnormal execution times	Displays P2P parameter No.1, block No.1 service abnormal execution times

[Table 2] List of communication flags based on P2P service setting

## Appendix

### 2) List of link devices (N)

P2P No. : 1 ~ 8, P2P block: 0 ~ 63

No.	Keyword	Type	Detail	Description
N00000	_P1B00SN	Word	P2P parameter No.1, block No.00 destination station No.	Saves P2P parameter No.1, block No.00 destination station number
N00001 ~ N00004	_P1B00RD 1	Device structure	P2P parameter No.1, block No.00 Read area device 1	Saves P2P parameter No.1, block No.00 Read area device 1
N00005	_P1B00RS 1	Word	P2P parameter No.1, block No.00 Read area size 1	Saves P2P parameter No.1, block No.00 Read area size 1
N00006 ~ N00009	_P1B00RD 2	Device structure	P2P parameter No.1, block No.00 Read area device 2	Saves P2P parameter No.1, block No.00 Read area device 2
N00010	_P1B00RS 2	Word	P2P parameter No.1, block No.00 Read area size 2	Saves P2P parameter No.1, block No.00 Read area size 2
N00011 ~ N00014	_P1B00RD 3	Device structure	P2P parameter No.1, block No.00 Read area device 3	Saves P2P parameter No.1, block No.00 Read area device 3
N00015	_P1B00RS 3	Word	P2P parameter No.1, block No.00 Read area size 3	Saves P2P parameter No.1, block No.00 Read area size 3
N00016 ~ N00019	_P1B00RD 4	Device structure	P2P parameter No.1, block No.00 Read area device 4	Saves P2P parameter No.1, block No.00 Read area device
N00020	_P1B00RS 4	Word	P2P parameter No.1, block No.00 Read area size 4	Saves P2P parameter No.1, block No.00 area size 4 to read saved
N00021 ~ N00024	_P1B00W D1	Device structure	P2P parameter No.1, block No.00 Save area device 1	Saves P2P parameter No.1, block No.00 Save area device 1
N00025	_P1B00W S1	Word	P2P parameter No.1, block No.00 Save area size 1	Saves P2P parameter No.1, block No.00 Save area size 1
N00026 ~ N00029	_P1B00W D2	Device structure	P2P parameter No.1, block No.00 Save area device 2	Saves P2P parameter No.1, block No.00 Save area device 2
N00030	_P1B00W S2	Word	P2P parameter No.1, block No.00 Save area size 2	Saves P2P parameter No.1, block No.00 Save area size 2
N00031 ~ N00034	_P1B00W D3	Device structure	P2P parameter No.1, block No.00 Save area device 3	Saves P2P parameter No.1, block No.00 Save area device 3
N00035	_P1B00W S3	Word	P2P parameter No.1, block No.00 Save area size 3	Saves P2P parameter No.1, block No.00 Save area size 3

## Appendix

No.	Keyword	Type	Detail	Description
N00036 ~ N00039	_P1B00W D4	Device structure	P2P parameter No.1, block No.00 Save area device 4	Saves P2P parameter No.1, block No.00 Save area device 4
N00040	_P1B00W S4	Word	P2P parameter No.1, block No.00 Save area size 4	Saves P2P parameter No.1, block No.00 Save area size 4
N00041	_P1B01SN	Word	P2P parameter No.1, block No.01 destination station No.	Saves P2P parameter No.1, block No.01 destination station number
N00042 ~ N00045	_P1B01RD 1	Device structure	P2P parameter No.1, block No.01 Read area device 1	Saves P2P parameter No.1, block No.01 Read area device 1
N00046	_P1B01RS 1	Word	P2P parameter No.1, block No.01 Read area size 1	Saves P2P parameter No.1, block No.01 Read area size 1
N00047 ~ N00050	_P1B01RD 2	Device structure	P2P parameter No.1, block No.01 Read area device 2	Saves P2P parameter No.1, block No.01 Read area device 1
N00051	_P1B01R S2	Word	P2P parameter No.1, block No.01 Read area size 2	Saves P2P parameter No.1, block No.01 Read area size 2
N00052 ~ N00055	_P1B01R D3	Device structure	P2P parameter No.1, block No.01 Read area device 3	Saves P2P parameter No.1, block No.01 Read area device 3
N00056	_P1B01R S3	Word	P2P parameter No.1, block No.01 Read area size 3	Saves P2P parameter No.1, block No.01 Read area size 3
N00057 ~ N00060	_P1B01R D4	Device structure	P2P parameter No.1, block No.01 Read area device 4	Saves P2P parameter No.1, block No.01 Read area device 4
N00061	_P1B01R S4	Word	P2P parameter No.1, block No.01 Read area size 4	Saves P2P parameter No.1, block No.01 Read area size 4
N00062 ~ N00065	_P1B01W D1	Device structure	P2P parameter No.1, block No.01 Save area device 1	Saves P2P parameter No.1, block No.01 Save area device 1
N00066	_P1B01W S1	Word	P2P parameter No.1, block No.01 saved area size 1	P2P parameter No.1, block No.01 saved area size 1 saved
N00067 ~ N00070	_P1B01W D2	Device structure	P2P parameter No.1, block No.01 saved area device 2	P2P parameter No.1, block No.01 saved area device 2 saved
N00071	_P1B01W S2	Word	P2P parameter No.1, block No.01 saved area size 2	P2P parameter No.1, block No.01 saved area size 2 saved
N00072 ~ N00075	_P1B01W D3	Device structure	P2P parameter No.1, block No.01 saved area device 3	P2P parameter No.1, block No.01 saved area device 3 saved

## Appendix

---

No.	Keyword	Type	Detail	Description
N00076	_P1B01W S3	Word	P2P parameter No.1, block No.01 saved area size 3	P2P parameter No.1, block No.01 saved area size 3 saved
N00077 ~ N00080	_P1B01W D4	Device structure	P2P parameter No.1, block No.01 saved area device 4	P2P parameter No.1, block No.01 saved area device 4 saved
N00081	_P1B01W S4	Word	P2P parameter No.1, block No.01 saved area size 4	P2P parameter No.1, block No.01 saved area size 4 saved

### Notes

- 1) If P2P parameters are to be specified with XG5000 used for N area, the setting will be performed automatically. And its modification during Run is also available by P2P dedicated command.
- 2) Since the addresses of N area available are classified according to P2P parameter setting No. and block index No., the area not used for P2P service can be used as an internal device.

# Appendix

## A.4 ASCII Code Table

American National Standard Code for Information Interchange

ASCII		Value	ASCII		Value	ASCII		Value	ASCII		Value
Hex	Dec		Hex	Dec		Hex	Dec		Hex	Dec	
00	000	NULL	40	064	@	80	128	€	C0	192	À
01	001	SOH	41	065	A	81	129	□	C1	193	Á
02	002	STX	42	066	B	82	130	,	C2	194	Â
03	003	ETX	43	067	C	83	131	f	C3	195	Ã
04	004	EQT	44	068	D	84	132	„	C4	196	Ä
05	005	ENQ	45	069	E	85	133	...	C5	197	Å
06	006	ACK	46	070	F	86	134	†	C6	198	Æ
07	007	BEL	47	071	G	87	135	‡	C7	199	Ç
08	008	BS	48	072	H	88	136	^	C8	200	È
09	009	HT	49	073	I	89	137	‰	C9	201	É
0A	010	LF	4A	074	J	8A	138	Š	CA	202	Ê
0B	011	VT	4B	075	K	8B	139	‹	CB	203	Ë
0C	012	FF	4C	076	L	8C	140	Œ	CC	204	Ì
0D	013	CR	4D	077	M	8D	141	□	CD	205	Í
0E	014	SO	4E	078	N	8E	142	Ž	CE	206	Î
0F	015	SI	4F	079	O	8F	143	□	CF	207	Ï
10	016	DLE	50	080	P	90	144	□	D0	208	Ð
11	017	DC1	51	081	Q	91	145	‘	D1	209	Ñ
12	018	DC2	52	082	R	92	146	’	D2	210	Ò
13	019	DC3	53	083	S	93	147	“	D3	211	Ó
14	020	DC4	54	084	T	94	148	”	D4	212	Ô
15	021	NAK	55	085	U	95	149	•	D5	213	Õ
16	022	SYN	56	086	V	96	150	–	D6	214	Ö
17	023	ETB	57	087	W	97	151	—	D7	215	×
18	024	CAN	58	088	X	98	152	~	D8	216	Ø
19	025	EM	59	089	Y	99	153	™	D9	217	Ù
1A	026	SUB	5A	090	Z	9A	154	š	DA	218	Ú
1B	027	ESC	5B	091	[	9B	155	›	DB	219	Û

# Appendix

ASCII		Value	ASCII		Value	ASCII		Value	ASCII		Value
Hex	Dec		Hex	Dec		Hex	Dec		Hex	Dec	
1C	028	FS	5C	092	\	9C	156	œ	DC	220	Ü
1D	029	GS	5D	093	]	9D	157	□	DD	221	Ý
1E	030	RS	5E	094	^	9E	158	ž	DE	222	þ
1F	031	US	5F	095	_	9F	159	ÿ	DF	223	ß
20	032	(space)	60	096	`	A0	160		E0	224	à
21	033	!	61	097	a	A1	161	ı	E1	225	á
22	034	"	62	098	b	A2	162	ç	E2	226	â
23	035	#	63	099	c	A3	163	£	E3	227	ã
24	036	\$	64	100	d	A4	164	¤	E4	228	ä
25	037	%	65	101	e	A5	165	¥	E5	229	å
26	038	&	66	102	f	A6	166	ı	E9	230	æ
27	039	'	67	103	g	A7	167	§	EA	231	ç
28	040	(	68	104	h	A8	168	¨	EB	232	è
29	041	)	69	105	i	A9	169	©	EC	233	é
2A	042	*	6A	106	j	AA	170	ª	ED	234	ê
2B	043	+	6B	107	k	AB	171	«	EE	235	ë
2C	044	`	6C	108	l	AC	172	¬	EF	236	ì
2D	045	-	6D	109	m	AD	173		F0	237	í
2E	046	.	6E	110	n	AE	174	®	F1	238	î
2F	047	/	6F	111	o	AF	175	¯	F2	239	ï
30	048	0	70	112	p	B0	176	°	F3	240	ð
31	049	1	71	113	q	B1	177	±	F4	241	ñ
32	050	2	72	114	r	B2	178	²	F5	242	ò
33	051	3	73	115	s	B3	179	³	F6	243	ó
34	052	4	74	116	t	B4	180	´	F7	244	ô
35	053	5	75	117	u	B5	181	µ	F8	245	õ
36	054	6	76	118	v	B6	182	¶	F9	246	ö
37	055	7	77	119	w	B7	183	·	FA	247	÷
38	056	8	78	120	x	B8	184	,	FB	248	ø
39	057	9	79	121	y	B9	185	¹	FC	249	ù
3A	058	:	7A	122	z	BA	186	º	FD	250	ú

## Appendix

---

ASCII		Value	ASCII		Value	ASCII		Value	ASCII		Value
Hex	Dec		Hex	Dec		Hex	Dec		Hex	Dec	
3B	059	;	7B	123	{	BB	187	»	FE	251	û
3C	060	<	7C	124		BC	188	½	FF	252	ü
3D	061	=	7D	125	}	BD	189	¾	EF	253	ý
3E	062	>	7E	126	~	BE	190	¿	EF	254	þ
3F	063	?	7F	127	□	BF	191	À	EF	255	ÿ

## A.5 Comparison Table of Ethernet Technology

Technology		Speed (Mbps)	Transmission Media	Max. Distance
Token Ring		4,16	UTP	100m
Ethernet	10BASE-T	10	UTP	100m
	10BASE-F(Multi Mode)	10	Optical Cable	Max. 2km
	10BASE-F(Single Mode)	10	Optical Cable	Max.2.5km
	10BASE-5	10	Coaxial Cable	500m
	10BASE-2	10	Coaxial Cable	185m
Fast Ethernet	100BASE-T4	100	UTP	100m
	100BASE-TX	100	UTP	100m
	100BASE-FX(Multi Mode)	100	Optical Cable	412m(Half Duplex) 2km(Full Duplex)
	100BASE-FX(Single Mode)	100	Optical Cable	20km
Gigabit Ethernet	1000BASE-T	1000	UTP	100m
	100BASE-FX(Single Mode)	1000	Optical Cable	3km
	100BASE-FX(Multi Mode)	1000	Optical Cable	500m
	100BASE-T	1000	Coaxial Cable	25m
100VG-AnyLAN		100	UTP	-
ATM		155-622	UTP, Optical Cable	-
FDDI(Single Mode)		100	Optical Cable	40-60km
FDDI(Multi-Mode)		100	Optical Cable	2km

## A.6 External Dimensions

XGL-EFMT/EFMF, XGL-EH5T is equal design.  
Please refer to a lower picture for the dimension.

Unit: mm

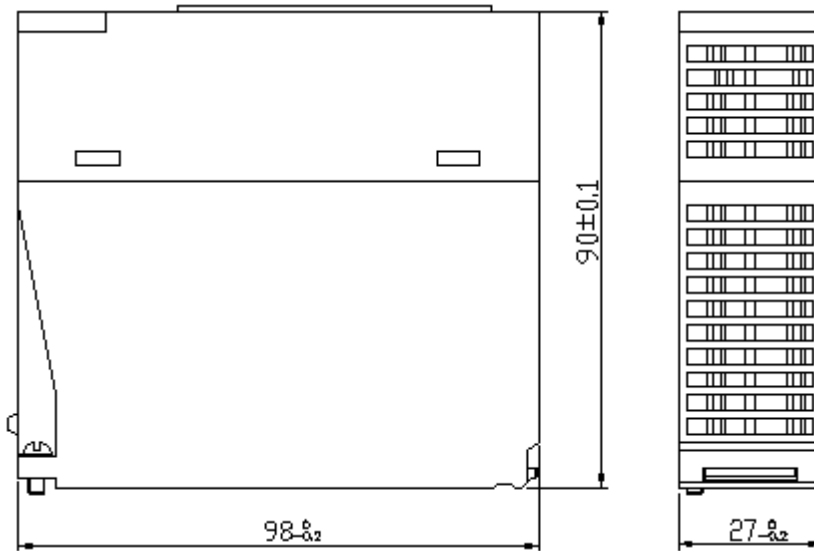

**Warranty**

- 1. Terms of warranty  
LSIS provides an 18-month warranty starting from the date of production.
  
- 2. Range of warranty  
For problems within the terms of the warranty, LSIS will replace the entire PLC or repair the defective parts free of charge except for the following cases.
  - (1) Problems caused by improper conditions, environment or treatment.
  - (2) Problems caused by external devices.
  - (3) Problems caused by the user remodeling or repairing the PLC.
  - (4) Problems caused by improper use of the product.
  - (5) Problems caused by circumstances where the expectations exceed that of the science and technology level when LSIS produced the product.
  - (6) Problems caused by natural disaster.
  
- 3. This warranty is limited to the PLC itself only. It is not valid for the system which the PLC is attached to.

**Environmental Policy**

LSIS Co., Ltd supports and observes the environmental policy as below.

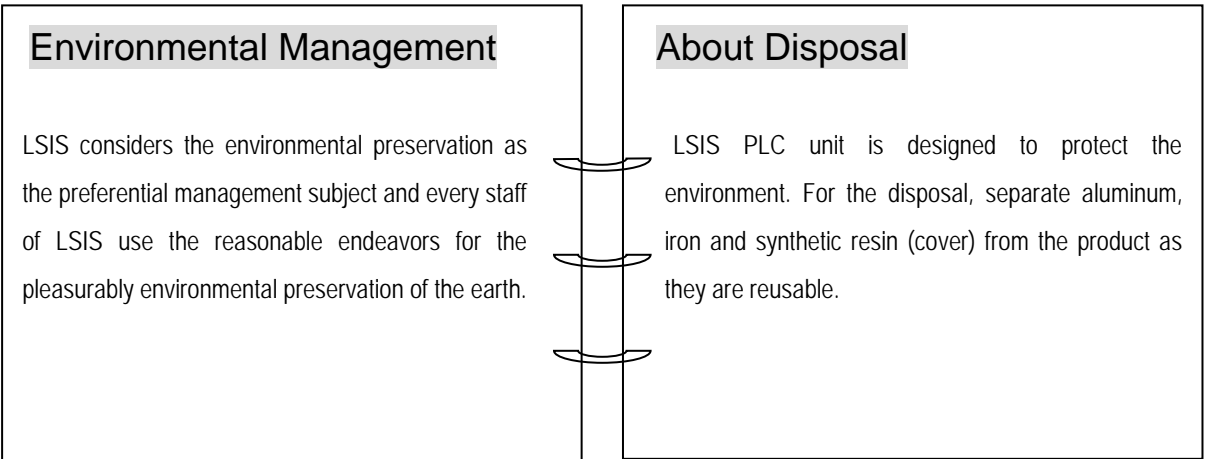



**LSIS values every single customers.**  
**Quality and service come first at LSIS.**  
**Always at your service, standing for our customers.**

<http://www.lsis.com>

**LSIS**

10310000634

■ **HEAD OFFICE**

LS Tower, 127, LS-ro, Dongan-gu, Anyang-si, Gyeonggi-Do, 431-848, Korea  
 Tel : (82-2)2034-4870/Fax : 82-2-2034-4648 E-mail : [cshwang@lsis.biz](mailto:cshwang@lsis.biz)

■ **LSIS Tokyo Office \_ Tokyo, Japan**

Address: 16FL, Higashi-Kan, Akasaka Twin Tower 17-22,  
 Akasaka, Monato-ku Tokyo 107-8470, Japan  
 Tel : 81-3-3582-9128/Fax : 81-3-3582-2667 e-mail : [jschuna@lsis.biz](mailto:jschuna@lsis.biz)

■ **LSIS (ME) FZE \_ Dubai, U.A.E.**

Address : Jafza View Tower Lob 19, Room 205 Along Sheikh Zayed  
 Road Jebel Aali Free Zone Dubai, United Arab Emirates  
 Tel : 971-4-886-5360/Fax : 971-4-886-5361 e-mail : [jungyongl@lsis.biz](mailto:jungyongl@lsis.biz)

■ **LSIS Shanghai Office \_ Shanghai, China**

Address : Room E-G, 12FL Hiamin Empire Plaza, No.726, West,  
 Yan'an Road Shanghai 200050, P.R. China e-mail : [liyong@lsis.com.cn](mailto:liyong@lsis.com.cn)  
 Tel : 86-21-5237-9977(609)/Fax : 89-21-5237-7189

■ **LSIS Beijing Office \_ Beijing, China**

Address : B-Tower 17FL, Beijing Global Trade Center B/D, No. 36,  
 East BeisanHuan-Road, DongCheng-District, Beijing 100013, P.R. China  
 Tel : 86-10-5825-6027(666)/Fax : 86-10-5825-6028 e-mail : [xunmi@lsis.com.cn](mailto:xunmi@lsis.com.cn)

■ **LSIS Guangzhou Office \_ Guangzhou, China**

Address : Room 1403.14FL, New Poly Tower,  
 2 Zhongshan Liu Road, Guangzhou, P.R. China  
 Tel : 86-20-8328-6754/Fax : 86-20-8326-6287 e-mail : [chenxs@lsis.com.cn](mailto:chenxs@lsis.com.cn)

■ **LSIS Chengdu Office \_ Chengdu, China**

Address : 12FL, Guodong Buiding, No.52 Jindun  
 Road Chengdu.610041, P.R. China  
 Tel : 86-28-8612-9151(9226)/Fax : 86-28-8612-9236 e-mail : [comysb@lsis.biz](mailto:comysb@lsis.biz)

■ **LSIS Qingdao Office \_ Qingdao, China**

Address : YinHe Bldg, 402 Room No. 2P Shandong Road,  
 Qingdao-City, Shandong-province 266071, P.R. China  
 Tel : 86-532-8501-6068/Fax : 86-532-8501-6057 e-mail : [wangzy@lsis.com.cn](mailto:wangzy@lsis.com.cn)

■ **LSIS Europe B.V. , Netherlands**

Address : 1st. Floor, Tupolevlaan 48, 1119NZ, Schiphol-Rijk, The Netherlands  
 Tel : +31 (0)20 654 1420/Fax : +31 (0)20 654 1429 e-mail : [junshickp@lsis.biz](mailto:junshickp@lsis.biz)

■ **Wuxi LSIS Co., Ltd \_ Wuxi, China**

Address : 102-A, National High & New Tech Industrial Development Area,  
 Wuxi, Jiangsu, 214028, P.R. China  
 Tel : 86-510-8534-6666/Fax : 86-510-8534-4078 e-mail : [caidx@lsis.com.cn](mailto:caidx@lsis.com.cn)

■ **Dalian LSIS Co., Ltd. \_ Dalian, China**

Address : No. 15, Liaohexi 3-Road, Economic and Technical Development zone,  
 Dalian 116600, China  
 Tel : 86-411-273-7777/Fax : 86-411-8730-7560 e-mail : [cuibx@lsis.com.cn](mailto:cuibx@lsis.com.cn)

※ LSIS constantly endeavors to improve its product so that  
 information in this manual is subject to change without notice.

© LSIS Co., Ltd 2011 All Rights Reserved.

2017.6